

Whynter 3-in-1 Compact Portable Air Conditioner, Dehumidifier, Fan, up to 400 sq ft 11000 BTU (6800 BTU SACC), Remote Control - White/Gray

Model # : ARC-115WG



Congratulations on your new Whynter product. To ensure proper operation, please read this Instruction Manual carefully before using this product. Keep this manual in a safe place for future reference.

Table of Contents

	<u>PAGE</u>
SAFETY PRECAUTIONS	3 - 5
PREPARATION	6
DESIGN NOTICE	6
EXHAUST HOSE INSTALLATION	6
CHOOSING THE RIGHT LOCATION	6
AMBIENT TEMPERATURE RANGE FOR UNIT OPERATION	7
TECHNICAL DATA	7
ACCESSORIES	8
WINDOW KIT INSTALLATION	8 - 9
FILTER INSTALLATION AND DRAINAGE	9
CONTROL PANEL	10
OPERATION INSTRUCTIONS	10 - 12
REMOTE CONTROL	12 - 13
CARE AND MAINTENANCE	13
TIPS	14
TROUBLESHOOTING	14 - 15
WARRANTY	16

SAFETY PRECAUTIONS

Read Safety Precautions Before Operation and Installation

To prevent death or injury to the user or other people and property damage, the following instructions must be followed. Incorrect operation due to ignoring of instructions may cause death, harm or damage.

- Installation must be performed according to the installation instructions. Improper installation can cause water leakage, electrical shock, or fire.
- Use only the included accessories and parts, and specified tools for the installation. Using non-standard parts can cause water leakage, electrical shock, fire, and injury or property damage. Make sure that the outlet you are using is grounded and has the appropriate voltage.
- The power cord is equipped with a three-prong grounding plug to protect against shock.
- Voltage information can be found on the nameplate of the unit.
- Your unit must be used in a properly grounded wall receptacle. If the wall receptacle you intend to use is not adequately grounded or protected by a time delay fuse or circuit breaker (the fuse or circuit breaker needed is determined by the maximum current of the unit. The maximum current is indicated on the nameplate located on unit), have a qualified electrician install the proper receptacle.
- Install the unit on a flat, sturdy surface. Failure to do so could result in damage or excessive noise and vibration.
- The unit must be kept free from obstruction to ensure proper function and to mitigate safety hazards.
- Do not modify the length of the power cord or use an extension cord to power the unit.
- Do not share a single outlet with other electrical appliances. Improper power supply can cause fire or electrical shock.
- Do not install your air conditioner in a wet room such as a bathroom or laundry room. Too much exposure to water can cause electrical components to short circuit.
- Ensure there is a minimum of 20" clearance around the unit and is clear from any combustible items such as propane, fire extinguishers, fuel, etc.
- The exhaust hose should always be used and should never be covered or blocked which can become a fire hazard.
- The unit has wheels to facilitate moving. Make sure not to use the wheels on thick carpet or to roll over objects, as these could cause tipping.
- Do not operate a unit that it has been dropped or damaged.
- Do not place the portable air conditioner close to any other heat generating appliances.
- Do not touch the unit with wet or damp hands or when barefoot.
- If the air conditioner is knocked over during use, turn off the unit and unplug it from the main power supply immediately. Visually inspect the unit to ensure there is no damage. If you suspect the unit has been damaged, contact a technician or customer service for assistance.
- In a thunderstorm, the power must be cut off to avoid damage to the machine due to lightning.
- Your air conditioner should be used in such a way that it is protected from moisture. e.g. condensation, splashed water, etc. Do not place or store your air conditioner where it can fall or be pulled into water or any other liquid. Unplug immediately if it occurs.
- All wiring must be performed strictly in accordance with the wiring diagram located inside of the unit.
- The unit's circuit board (PCB) is designed with a fuse to provide overcurrent protection. The specifications of the fuse are printed on the circuit board, such as: T 3.15A/250V, etc.
- When the water drainage function is not in use, keep the upper and the lower drain plug firmly plugged into to the unit to prevent a choking hazard by children.

CAUTION

- This appliance is not intended for use by persons (including children) with reduced physical, sensory or mental capabilities or lack of experience and knowledge, unless they have been given supervision or instruction concerning use of the appliance by a person responsible for their safety. Children should be supervised to ensure that they do not play with the appliance.
- Children must be supervised around the unit at all times.
- If the supply cord is damaged, it must be replaced by the manufacturer, its service agent or similarly qualified persons in order to avoid a hazard.
- Prior to cleaning or other maintenance, the appliance must be disconnected from the supply mains.
- Do not remove any fixed covers. Never use this appliance if it is not working properly, or if it has been dropped or damaged.

CAUTION

- Never use this appliance if it is not working properly, or if it has been dropped or damaged.
- Do not run cord under carpeting. Do not cover cord with throw rugs, runners, or similar coverings. Do not route cord under furniture or appliances. Arrange cord away from traffic area and where it will not be tripped over.
- Do not operate unit with a damaged cord, plug, power fuse or circuit breaker. Return to an authorized service facility for examination and/or repair.
- To reduce the risk of fire or electric shock, do not use this fan with any solid-state speed control device.
- The appliance shall be installed in accordance with national wiring regulations.
- Contact the manufacturer or authorized service technician for repair or maintenance information of this unit.
- Contact the manufacturer or authorized installer for installation questions of this unit.
- Do not cover or obstruct the inlet or outlet grilles.
- Do not use this product for functions other than those described in this instruction manual.
- Before cleaning, turn off the power and unplug the unit.
- Disconnect the power if strange sounds, smell, or smoke comes from it and contact the manufacturer or authorized service technician for assistance.
- Do not press the buttons on the control panel with anything other than your fingers.
- Do not remove any fixed covers. Contact Whynter Customer Support if this unit if it is not working properly, or if it has been dropped or damaged.
- Do not operate or stop the unit by inserting or pulling out the power cord plug.
- Do not use hazardous chemicals to clean or come into contact with the unit. Do not use the unit in the presence of inflammable substances or vapor such as alcohol, insecticides, petrol, etc. Always transport your air conditioner in a vertical position and stand on a stable, level surface during use.
- Always contact Whynter Customer Support for replacement parts compatible with your unit.
- Turn off the product when not in use.

WARNING

- The appliance shall be stored in a room without continuously operating ignition sources (for example: open flames, an operating gas appliance or an operating electric heater).
- Do not pierce or burn the unit.
- Be aware that the refrigerants may not contain an odor.

SAFETY COMPLIANCE

- Keep ventilation openings clear of obstruction.
- The appliance shall be stored so as to prevent mechanical damage from occurring.
- A warning that the appliance shall be stored in a well-ventilated area where the room size corresponds to the room area as specified for operation.
- Any person who is involved with working on or breaking into a refrigerant circuit should hold a current valid certificate from an industry-accredited assessment authority, which authorizes their competence to handle refrigerants safely in accordance with an industry recognized assessment specification.
- Servicing shall only be performed as recommended by the equipment manufacturer.
- Maintenance and repair requiring the assistance of other skilled personnel shall be carried out under the supervision of the person competent in the use of flammable refrigerants.
- Please follow the instructions carefully to handle, install, clear, and service the air conditioner to avoid any damage or hazard. Flammable Refrigerant R32 is used within air conditioner. When maintaining or disposing the air conditioner, the refrigerant (R32) shall be recovered properly and shall not discharge to air directly.
- No any open fire or device which may generate spark/arcing shall be around air conditioner to avoid causing ignition of the flammable refrigerant used.
- Please follow the instruction carefully to store or maintain the air conditioner to prevent mechanical damage from occurring.
- Flammable refrigerant R32 is used in air conditioner. Please follow the instruction carefully to avoid any hazard. For specific information on the type of gas and the amount, please to the relevant label on the unit itself.

SAFETY COMPLIANCE

WARNING

Do not use means to accelerate the defrosting process or to clean, other than those recommended by the manufacturer. The appliance shall be stored in a room without continuously operation ignition sources (for example: open flames, an operating gas appliance or an operating electric heater.)

Do not pierce or burn.

Be aware that refrigerants may not contain an odor.

NOTE: The manufacturer may provide other suitable examples or may provide additional information about the refrigerant odor.



Warning; Risk of fire/Flammable materials



operator's manual; operating instructions



service indicator; read technical manual

DANGER – Risk Of Fire Or Explosion. Flammable Refrigerant Used. To Be Repaired Only By Trained Service Personnel. Do Not Puncture Refrigerant Tubing. CAUTION – Risk Of Fire Or Explosion. Dispose Of Properly In Accordance With Federal Or Local Regulations. Flammable Refrigerant Used.



Caution, risk of fire

PREPARATION

All illustrations in the manual are for explanation purpose only. Your machine may be slightly different. The actual shape shall prevail. The unit can be controlled by the unit control panel alone or with the remote controller.

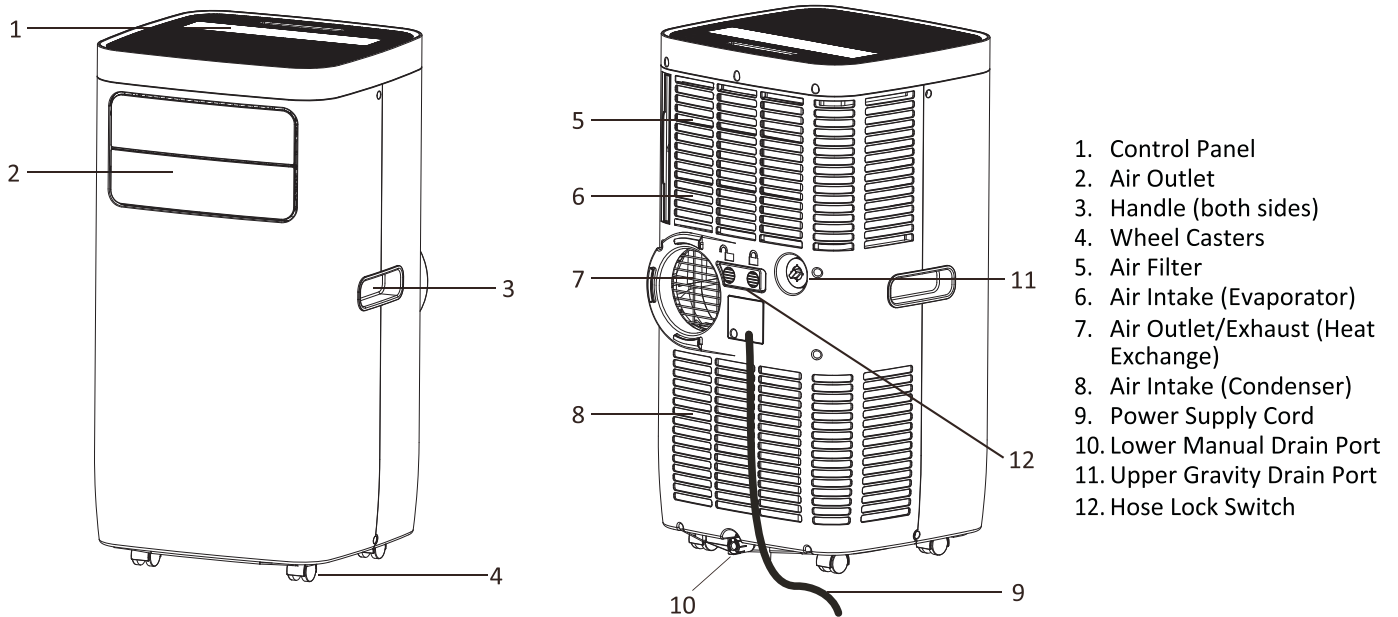

DESIGN NOTICE

In order to ensure the optimal performance of our products, the design specifications of the unit and remote control are subject to change without prior notice.

EXHAUST HOSE INSTALLATION

The exhaust hoses and adapter must be installed or removed in accordance with the usage mode. For COOL mode, the adapter and exhausts must be installed. For FAN or DRY mode, the adapter and exhaust hoses can optionally be removed.

CHOOSING THE RIGHT LOCATION

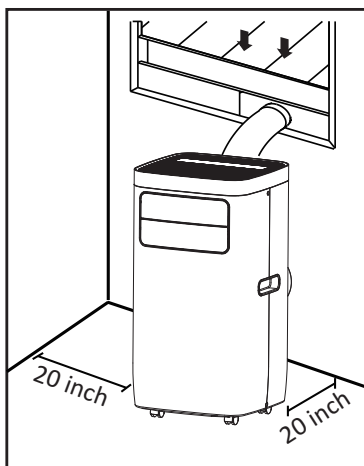

Your installation location should meet the following requirements:

- Make sure that you install your unit on an even surface to minimize noise and vibration.
- The unit must be installed near a grounded plug, and the lower manual gravity drain port (found on the back of the unit) must be accessible.
- The unit should be located at least 20" from the nearest wall to ensure proper air conditioning. The horizontal louver blade should be at least 20" away from obstacles.
- DO NOT cover any of the intake and exhaust vents or the remote signal receptor of the unit, as this could cause damage to the unit.

AMBIENT TEMPERATURE RANGE FOR UNIT OPERATION

MODE	TEMPERATURE RANGE
Cool	61°F - 95°F (16°C - 35°C)
Dry	61-89°F 16-32°C

TECHNICAL DATA

What should I look for first when purchasing a portable air conditioner?

The right air conditioner helps you cool a room efficiently. An undersized unit won't cool adequately while one that's too large will not remove enough humidity, leaving the air feeling damp. To find the proper air conditioner, determine the square footage of the room you want to cool by multiplying the room length by its width. You also need to know the air conditioner's BTU (British Thermal Unit) rating, which indicates the amount of heat it can remove from a room. Why is the cooling capacity lower on newer models than on older units? A higher number means more cooling power for a larger room. (Be sure you are comparing only newer models to each other- older models may appear to have a higher capacity, but are actually the same). Be sure to "size up" if your portable air conditioner will be placed in a very sunny room, in a kitchen, or in a room with high ceilings. After you've found the right cooling capacity for your room, you can look at other features.

Why is the cooling capacity lower on newer models than on older units?



Federal regulations require manufacturers to calculate cooling capacity based on a specific test procedure, which was changed just this year. Models manufactured before 2017 were tested under a different procedure and cooling capacity is measured differently than in previous models. So, while the BTUs may be lower, the actual cooling capacity of the air conditioners has not changed.

What is SACC ?

SACC is the representative value of Seasonally Adjusted Cooling Capacity, in Btu/h, as determined in accordance with the DOE test procedure at title 10 Code of Federal Regulations (CFR) 430, subpart B, appendix CC and applicable sampling plans.

Model	ARC-115WG
Operational Modes:	Cool / Fan / Dry
Cooling Capacity (SACC):	ASHRAE: 11,000 BTU / SACC : 6,800 BTU
Dehumidifying Capacity:	87 pints/day
Coverage Area:	400 sq. ft.
Fan Speed:	Low, Medium, High
Temperature Range:	61-89°F
Timer:	Up to 24 hours
Refrigerant:	R32
Power Consumption:	1050 W / 9.5 A
Power Supply:	115V/60Hz
Net Weight:	56.2 lbs
Gross Weight:	68 lbs
Unit Dimensions:	14.75" W x 28" H x 13.75" D
Extendable Exhaust Hose:	5.5" diameter, length up to 59"
Hose Connectors:	5.5" diameter
Window Kit:	Minimum length: 20" Maximum length: 46"

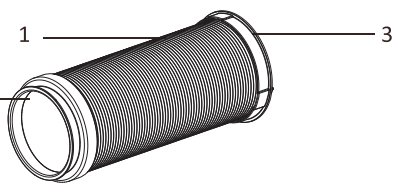
ACCESSORIES

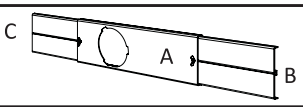
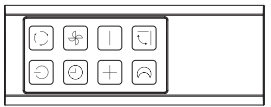
ACCESSORY IMAGE	ACCESSORY DESCRIPTION	QUANTITY
	1. Exhaust hose 2. Connector (to the window kit) 3. Connector (to the unit)	3 pieces
	Cover	1 piece
	Window slider kit with (2) screws and (2) nuts	1 set
	Remote Control	1 piece

WINDOW KIT INSTALLATION

- Slide the hose assembly with the exhaust connector to unit into the exhaust port of the rear panel and push the lock switch to lock the hose assembly firmly in place.

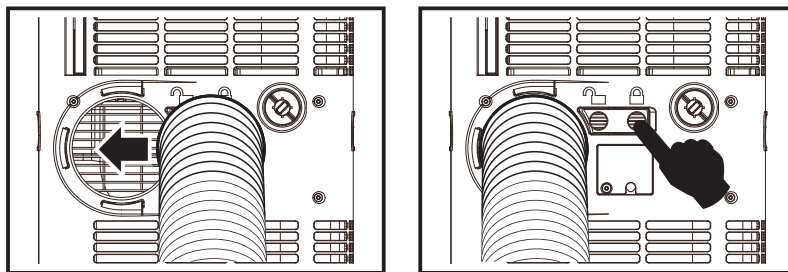

- Insert window panels B and C to each end of the main panel A with the exhaust port cut out. Adjust the length of the window panel kit by using the screws and nuts mounted on the two ends of the main panel A.

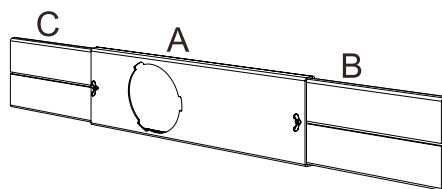

- Open the window and place the window panel kit into the window. Adjust the extension panels B and C to fit width or height of window using the screw and nut sets mounted on the main panel A.

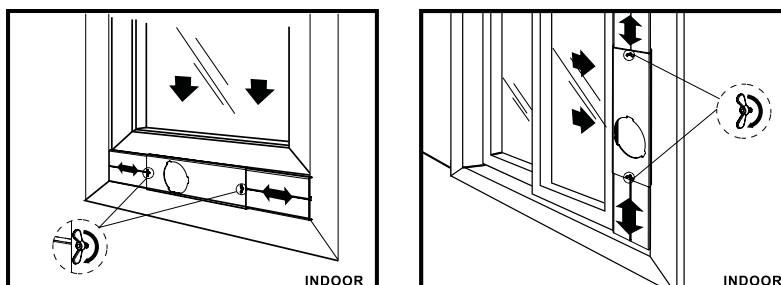

WINDOW KIT INSTALLATION

4. Insert the other end of exhaust hose assembly with the exhaust connector onto the window panel kit and turn counterclockwise to secure.

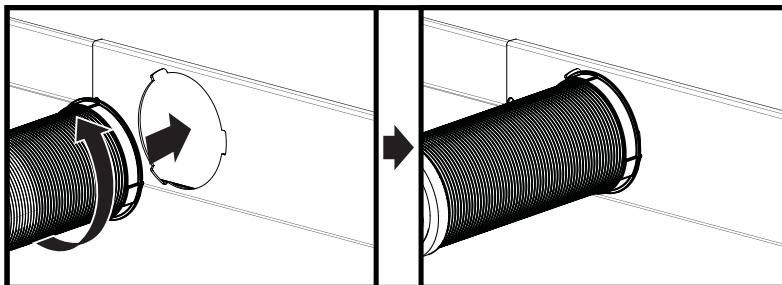

5. Plug the power cord into the wall outlet and press the “Reset” button.

6. Please allow 20” of space around the unit for proper air circulation.

7. When removing the portable air conditioner for storage, the window panel may be left in place. Simply place the included cover to cover the hole on the window panel.

FILTER INSTALLATION AND DRAINAGE

WARNING: NEVER OPERATE THE AIR CONDITIONER WITHOUT THE AIR FILTER

Your Whynter portable air conditioner is equipped with a washable filter. This washable filter removes large particles such as dust, pet hair and dander.

WATER DRAINAGE

The dehumidifying capacity of this unit is 87 pints per day. The patented self-evaporating function of the ARC-115WG unit fully exhausts all condensation automatically in most environments when humidity is less than 70%. Areas with more than 70% humidity, the self-evaporating function can still exhaust about 98% of the moisture and the remaining 2% of moisture will be collected in the water tank of the air conditioner.

When the water reservoir reaches its maximum level, the water full indicator light \triangle will illuminate and all operation modes will be disabled temporarily while the fan continuously runs. The water full indicator light will disappear when the water is completely drained.

Continuous drainage (Fig. A) - optional

Remove the drain cover and soft rubber stopper from the upper drain port. Install the drain hose (sold separately) through the drain cover. Thread the drain cover onto the drain port. Place the open end of the drain hose downward to an area appropriate for draining.

Manual drainage (Fig. B)

Carefully move the unit to a drain location or position a flat container, dish or optional drain bucket accessory (sold separately) under the drain area of the lower drain port. Remove the bottom drain plug and let the water drain. Replace the drain plug and plug in to resume operation.

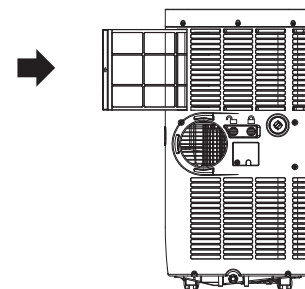

Fig. A

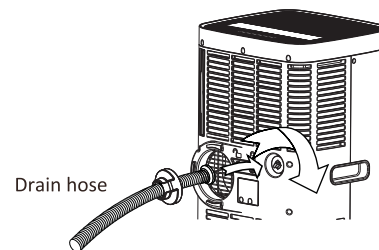
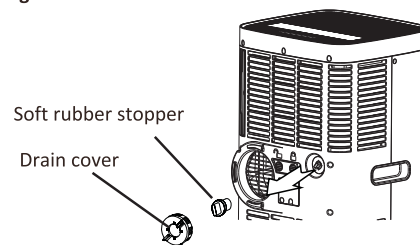
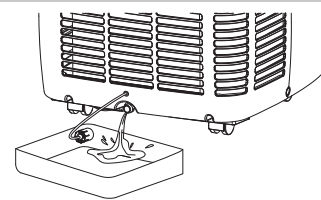

Fig. B



CONTROL PANEL



Power

Press to turn the air conditioner on and off.

Sleep Mode

Press to activate Sleep mode and the sleep light illuminates. Press SLEEP button again to stop the SLEEP operation.



Timer

Press to program timer delayed switch ON or OFF function.

Modes

Press to change modes. Controls the functions modes: COOL , DRY , and FAN . See page 11.

Fan

Press to change fan speed. Controls the 3 fan speeds and mode: Low, Medium, and High   .
The fan speed indicator lights illuminate to show the set fan speed/mode.

Up and Down buttons

Adjusts set temperature 1°F | 1°C increments or timer hours (0 - 24 hours).

NOTE: This unit is capable of displaying set temperature in Fahrenheit or Celsius. To convert from one to another, press and hold the Up and Down buttons for 3 seconds.

Swing

Press to start the auto swing feature. When the operation is ON, press the SWING button to stop the louver at a desired angle.

LED Display

Shows the set temperature in °F or °C and the Auto-timer settings. While on FAN modes, it shows the room temperature.

Tank Full

If the internal condensation tank becomes full, the Tank Full light will turn RED and the unit will not operate until it has been drained from the lower manual drain port.

Error Codes

E1 - Room temperature sensor error - Unplug unit and restart in 5 minutes

E2 - Evaporator sensor error - Unplug unit and restart in 5 minutes

Note: If any other error code appears on the display, unplug the air conditioner and allow it to sit undisturbed for 5 minutes. If the error code persists when the unit is plugged back in, please contact Whynter Customer Support.

OPERATION INSTRUCTIONS

BEFORE USING YOUR APPLIANCE

- Remove the exterior and interior packing
- Before connecting the appliance to the power source, let it stand upright for approximately 4 hours. This will reduce the possibility of a malfunction in the cooling system from handling during transportation

OPERATION INSTRUCTIONS

SWITCHING ON/OFF THE AIR CONDITIONER ⏻

The appliance can be switched ON or OFF by pressing the POWER button on the control panel or the ON/OFF button on the remote control

COOLING MODE ❄️

In this mode, the air conditioner cools and dehumidifies the room. To activate this function mode, press the MODE button until the COOL indicator light comes on. When the cooling mode is set, the compressor will start in approximately 3 minutes. In cooling mode, hot air is exhausted from the outdoor exhaust port and the exhaust hose must be connected to exhaust out the hot air. The temperature setting range of this air conditioner is from 61°F / 16°C to 89°F / 32°C. To set the temperature, press the + or - buttons. This air conditioner has a 5°F temperature cushion which if the set temperature is within 5°F of the ambient temperature, the unit runs on fan only mode. This saves energy and prolongs the life of the compressor of the air conditioner. To set the fan speed, press the FAN button.

NOTE: In cooling mode, the difference in noise level between the fan speeds is not very noticeable when the compressor is on. Try setting the unit to Fan only mode, you should be able to hear the difference between high and low fan speed settings.

DRY (DEHUMIDIFYING) ONLY MODE 💧

In this mode, the air conditioner only dehumidifies the room, the compressor will activate intermittently depending on the ambient temperature and the fan speed is set to LOW. To activate this function mode, press the MODE button until the DRY indicator light is displayed. Please note that when switching function mode, there will be an approximately 3 minute transition time. In dehumidifying mode, the exhaust hose does not need to be vented. If the exhaust hose is vented, the room will be cooled as it dehumidifies. To prevent cooling, remove the exhaust hose from the window kit and allow the warm air from the rear to be recirculated into the room. If room temperature is higher than 77°F, the fan speed can be adjusted. If room temperature is lower than 77°F, the fan speed is set at Low.

NOTE: When using dehumidifying mode, venting the exhaust hose to the outside is not required. If vented, the warm air is exhausted to the outside and cooling within the room may occur. Additionally, if the exhaust hose is not vented, the unit may require more frequent draining. Also, the air conditioner does not have a humidistat in which a specific humidity level can be set.

FAN ONLY MODE 🌀

In this mode, only the fan of the air conditioner runs and circulates the air in the room. To activate this function mode, press the MODE button until the FAN indicator light comes on. In this function mode, the temperature cannot be set. Subsequently, set the desired fan speed by pressing the FAN button. When using FAN only mode, venting the exhaust hose to the outside is optional.

TIMER (DELAYED SWITCH ON / OFF) FUNCTION ⌚

This function mode enables a delayed switch ON or delayed switch OFF of the air conditioner. The time (hours) delay can be set, enabled and disabled.

SETTING SWITCH OFF TIMER

With the air conditioner operating in any function mode, press the TIMER button. The TIMER OFF light will come on. Then set the desired time delay OFF hours by pressing the UP and DOWN buttons. The time increments are followed by 1 hour increment up to 24 hours. When the delay time set has elapsed, the air conditioner switches off. To cancel the delayed switch off function, turn off the air conditioner or adjust the time setting to 0.0.

SETTING DELAYED SWITCH ON TIMER

With the air conditioner is off, press the TIMER button. The TIMER ON light will come on. Then set the desired time delay ON hours by pressing the UP and DOWN buttons. The time increments are followed by 1 hour increment up to 24 hours. When the delay time set has elapsed, the air conditioner switches on. To cancel the delayed switch on function, turn on the air conditioner or adjust the time setting to 0.0.

OPERATION INSTRUCTIONS

SLEEP MODE

In this mode, the air conditioner gradually increases the set temperature in cooling mode, decreases the noise level and conserves energy. The temperature will then increase by another 1°C/ 1°F after an additional 30 minutes. This new temperature will remain the same for 7 hours. To activate this function mode, press the SLEEP button until the SLEEP indicator light comes on.

AUTO RESTART

In the event of a power outage, the air conditioner restarts at the previously set function mode and settings when power is restored.

CONTROLLING THE AIR FLOW DIRECTION

The louvers can be controlled to Auto-Swing or in a fixed direction. To control the air flow direction by Auto-Swing, press the SWING button. To set the louvers in a fixed angle or direction, press SWING button while on Auto-Swing mode when desired angle is chosen.

NOISE LEVEL

Portable air conditioners may make sounds that are not familiar to you. The sounds listed below are normal. Noise reflecting off hard surfaces such as a floor or wall can make the sounds seem louder than they actually are.

- The compressor may make a pulsating or high-pitched sound
- Water running from the evaporator to the water tank may make a splashing sound
- Refrigerant flowing may make a gurgling sound
- Fan sound may come from front and back air vents

COMPRESSOR LOCK OUT

This portable air conditioner is optimized to operate in an ambient temperature of 61°F - 95°F (16°C - 35°C). The compressor circuit has an automatic 3 minute time delayed start if the unit is turned off and on quickly. This prevents overheating of the compressor and possible circuit breaker tripping.

REMOTE CONTROL

The portable air conditioner can be switched on by the remote control. To transmit signals from the remote control to the air conditioner, point the front part of the remote handset towards the control panel on the air conditioner. Reception of the signal is confirmed by a beep. The maximum signal transmission distance is approximately 8 meters / 26 feet.

- Other appliances in the same room controlled by a remote control (TV, radio, stereo, etc.), may cause interferences
- Electronic and fluorescent lamps may interfere with the signal transmissions between the remote control and the air conditioner
- Remove the batteries if the remote control is not used for long periods

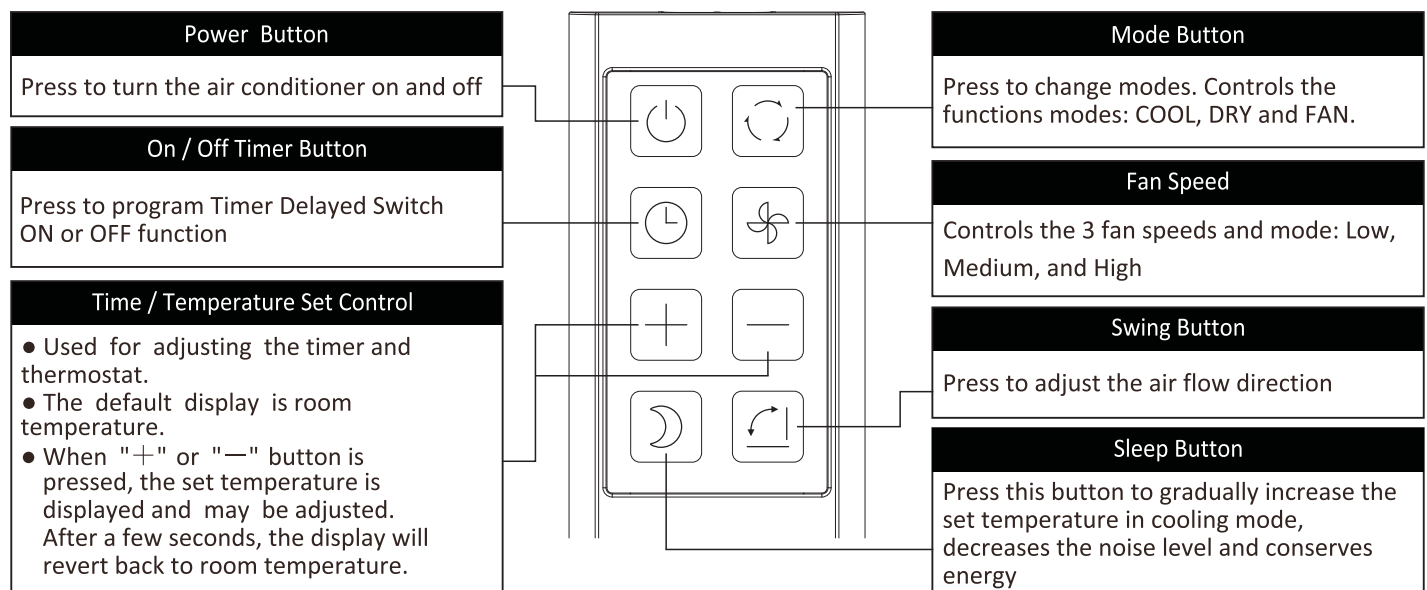

REMOTE CONTROL

INSTALLING BATTERIES

To insert the batteries, open the flap on the back of the remote control by removing it. Strictly adhere to the polarity signs on the bottom of the battery housing, close the flap once the batteries have been inserted.

- Only use two dry LR03 AAA 1.5V Batteries (included) in the remote control
- Always change both batteries at the same time

REPLACING THE REMOTE BATTERIES

This air conditioner comes with two AAA batteries. Place the batteries in the remote control before use.

1. Remove the back cover from the remote downward to expose the battery compartment.
2. Insert the batteries, ensure to match the (+) and (-) symbols on the ends of the batteries with the symbols inside the battery compartment.
3. Remove the battery cover back into place.

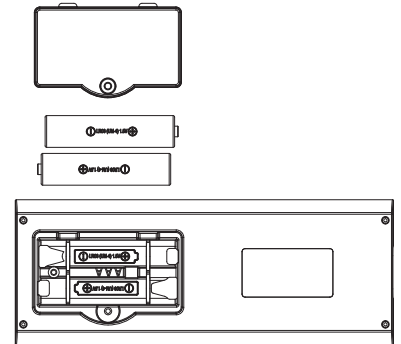

Notes:

- The air conditioner will not respond if curtains, doors or other materials block the signal from the remote control to the unit.
- Prevent any liquid from contact with the remote control. Do not expose the remote control to direct sunlight or heat.
- If the infrared signal receiver on the indoor unit is exposed to direct sunlight, the air conditioner may not function properly. Use curtains to prevent the sunlight from falling on the receiver.
- Do not mix old and new batteries or batteries of different types.
- Do not leave the batteries in the remote control if it is not going to be used for more than two months.

CARE AND MAINTENANCE

- Always unplug the unit before cleaning or servicing.
- DO NOT use flammable liquids or chemicals to clean the unit.
- DO NOT wash the unit under running water. Doing so causes electrical danger.
- DO NOT operate the portable air conditioner if the power supply was damaged during cleaning. A damaged power cord must be replaced with a new cord. Contact Whynter Customer Support for more information.

UNIT CLEANING

- Unplug the appliance before cleaning or servicing.
- Clean the housing with a lukewarm damp cloth and neutral detergent. Dry the housing with a lint-free dry cloth.
- Do not use gasoline, paint thinner or other chemicals to clean the appliance.
- Do not wash the appliance directly under a tap or using a hose. It may cause electrical damage.

AIR FILTERS

The air filter should be cleaned every two weeks to ensure efficient performance. In households with animals, the air filters may need to be cleaned more often and the external grills may need to be wiped to prevent blocked air flow.

END OF SEASON STORAGE

1. Drain all water from the appliance.
2. Run the appliance on Fan mode for half a day in a warm room to dry the inside of the appliance and prevent mold formation.
3. Turn off the appliance and unplug it, wrap the cord and bundle it with tape.
4. Remove the batteries from the remote control.
5. Clean the air filters and reinstall them.
6. Store the appliance in a cool, dark place. Prolonged exposure to direct sunlight or extreme heat can shorten the lifespan of the appliance.

DISPOSAL

This appliance should not be treated as regular household waste. Check for local regulatory compliance regarding the approved and safe disposal of this appliance.

TIPS

1. Keep the exhaust hose as short and straight as possible.
The exhaust hose removes heat from the room. It should remain as short and straight as possible without sharp bends or twists to maximize efficiency. If the exhaust hose must be extended, do not exceed 9'.
2. Turn the air conditioner on early.
Turning the air conditioner on early instead of waiting until the hottest point of the day will allow the unit to be more effective. The air conditioner will not have to work as hard to cool the room down and maintain the set temperature.
3. Reduce heat sources.
Direct sunlight, televisions, computers, and other heat generating appliances work against the air conditioner by introducing heat into the space.
 - Close window curtains and blinds to keep direct sunlight out
 - Close doors and windows
 - Keep ovens and stoves off
 - Turn off unused lights
 - Add weather stripping around windows and doors
4. Keep the air filter clean.
Regular cleaning will help keep your air conditioner working properly. Dusty filters and vents greatly reduce the airflow and efficiency of the unit.
 - Clean the washable filter regularly
 - Vacuum any accumulated dust from around all vents

TROUBLESHOOTING

Many common portable air conditioner problems are easily resolved. Try the troubleshooting suggestions below to see if the problems can be resolved before having to contact the service department.

PROBLEM	POSSIBLE CAUSES	SOLUTIONS
The portable air conditioner does not turn on	Power failure / outage <ul style="list-style-type: none"> • The automatic switch, line fuse, or breaker has been tripped • The power supply voltage is too low • The power cord is damaged • The L.C.D.I. power plug for the unit is tripped • The internal water reservoir is full 	<ul style="list-style-type: none"> • Restore the power supply • Flip the switch / change the fuse / turn the breaker back on. Also note that you may have too many appliances drawing power on one circuit, you may need to move the other appliances to another circuit • Move the unit onto another circuit with the correct voltage • Call for service. Only authorized personnel should replace damaged power cord or power plug • Press the Reset button on the L.C.D.I. power plug • Drain water from the air conditioner • Possible loose internal connection. • Please contact Whynter for service.

PROBLEM	POSSIBLE CAUSES	SOLUTIONS
The unit turns on but the compressor does not turn on (the fan runs but the unit is not cooling)	<ul style="list-style-type: none"> • The room temperature is outside of the operational tolerances of the unit • The Cooling mode is not on • The compressor has not turned on yet because of its time delay • The set temperature is too high • The internal water reservoir is full 	<ul style="list-style-type: none"> • This unit is designed to work in ambient temperatures of 61°F to 95°F. • Press the MODE button until the COOL light is shown on the display. • Give the compressor 3 minutes to turn on after the Cooling mode has been selected. • Set the air conditioner to a lower temperature. • It is recommended to set the temperature to at least 5°F of the ambient temperature. • Either manually drain the water by removing the drain plug or allow the unit to exhaust the water itself by running the fan only mode. Then cooling will resume. • Possible loose internal connection. • Please contact Whynter for service.
The air coming out of the unit is not very cold, or the airflow volume is weak	<ul style="list-style-type: none"> • The filters are dirty or obstructed • The air intake or exhaust is obstructed • The unit is set in DRY or FAN mode • The unit is set to low fan speed 	<ul style="list-style-type: none"> • Clean the air filters • Make sure there is at least 20" of clearance from the air intake. Make the length of the exhaust hose is as short as possible • Set the unit to the cooling mode • Set the unit to a higher fan speed
The unit has worked for a long time, but the room is not cold enough	<ul style="list-style-type: none"> • Windows or doors are open • There are too many people in the room • There is direct sunshine into the room • The room is a kitchen or with many heat producing appliances • There is a server in the room • The room is too large 	<ul style="list-style-type: none"> • Close all windows and doors • You may need additional cooling or another air conditioner. • Close curtains or blinds and try to minimize the amount of direct sunlight into the room. • You may need additional cooling or another air conditioner.
The unit is very noisy	<ul style="list-style-type: none"> • The unit is not level • The surface underneath the unit is uneven • Low power voltage 	<ul style="list-style-type: none"> • Make sure the unit is on hard, level and stable surface. • Move the unit to a location with a level and hard floor. • Make sure the wall outlet and support the required power consumption of the air conditioner and do not use an extension cord.
The unit leaks water	<ul style="list-style-type: none"> • The unit is tilted or not leveled • The water tank is full 	<ul style="list-style-type: none"> • Make use the unit is leveled • Drain water from the drain plug at the back of the air conditioner
Fan speed cannot be changed	<ul style="list-style-type: none"> • Fan speed differences are not very noticeable 	<ul style="list-style-type: none"> • The fan speed difference is not very noticeable when the compressor is on. Try setting the unit to Fan only mode, you should be able to hear the difference between high and low fan speed settings.

ONE YEAR LIMITED PARTS WARRANTY

THREE YEAR WARRANTY ON COMPRESSOR

This WHYNTER product is warranted to the original owner, purchased from an authorized Whynter dealer within the 48 U.S. continental states, for one year from the original purchase date against defects in material and workmanship under normal residential usage. Should your WHYNTER product prove defective within one year from the date of purchase, contact Whynter's Customer Support team with the serial number and proof of purchase to make a warranty claim. A Return Authorization number must be issued before returning any parts or products. Parts or products received without a Whynter issued Return Authorization number will be refused. Under this warranty, Whynter will repair or replace any parts found defective with new or remanufactured parts or exchange the defective product with a new, refurbished, or remanufactured product at our discretion. All defective products and parts covered by this warranty will be repaired or replaced on a mail-in basis to Whynter's Service Center. This warranty is not transferable. After the expiration of the warranty, the cost of labor and parts will be the responsibility of the original owner.

After two months to one year, the customer will be responsible for the return freight cost to Whynter's Service Center. Please package the product carefully in its original packaging to avoid damage in transit. Whynter is not responsible for damage resulting from shipper mishandling or improper packaging. Please retain the original box and packaging materials.

THIS WARRANTY DOES NOT COVER:

- Acts of God, such as fire, flood, hurricanes, earthquakes and tornadoes.
- Improper power supply such as power surge, low voltage, defective household wiring or inadequate fuses.
- Use in commercial or industrial applications.
- Damage, accidental or otherwise, to the product while in the possession of a consumer not caused by a defect in material or workmanship.
- Damage caused by consumer misuse, tampering, lack of maintenance or failure to follow the care and special handling provisions in the instructions.
- Damage to the finish of the case, or other appearance parts caused by wear.
- Damage caused by repairs or alterations to the product by anyone other than authorized by the manufacturer.
- Removal, Replacement Packaging, Freight and Insurance cost for the warranty service.
- Products sold AS IS or from an unauthorized reseller.
- Products that have had their serial numbers removed or defaced.

DISCLAIMER OF IMPLIED WARRANTIES; LIMITATION OF REMEDIES

CUSTOMER'S SOLE AND EXCLUSIVE REMEDY UNDER THIS LIMITED WARRANTY SHALL BE PRODUCT REPAIR OR REPLACEMENT AS PROVIDED HEREIN. CLAIMS BASED ON IMPLIED WARRANTIES, INCLUDING WARRANTIES OF MERCHANTABILITY OR FITNESS FOR A PARTICULAR PURPOSE, ARE LIMITED TO ONE YEAR OR THE SHORTEST PERIOD ALLOWED BY LAW, BUT NOT LESS THAN ONE YEAR. WHYNTER SHALL NOT BE LIABLE FOR CONSEQUENTIAL OR INCIDENTAL DAMAGES SUCH AS PROPERTY DAMAGE AND INCIDENTAL EXPENSES RESULTING FROM ANY BREACH OF THIS WRITTEN LIMITED WARRANTY OR ANY IMPLIED WARRANTY. SOME STATES AND PROVINCES DO NOT ALLOW THE EXCLUSION OR LIMITATION OF INCIDENTAL OR CONSEQUENTIAL DAMAGES, OR LIMITATIONS ON THE DURATION OF IMPLIED WARRANTIES, SO THESE LIMITATIONS OR EXCLUSIONS MAY NOT APPLY TO YOU. THIS WRITTEN WARRANTY GIVES YOU SPECIFIC LEGAL RIGHTS. YOU MAY ALSO HAVE OTHER RIGHTS THAT VARY FROM STATE TO STATE.

To obtain service or information, contact
Whynter LLC via email at support@whynter.com or call
866-WHYNTER.

Product contents and specifications may change without notice.

Copyright © 2023
WWW.WHYNTER.COM