

SYLVANIA Luminaires

UltraLED™ RT Downlight Dual Selectable

Application

The SYLVANIA UltraLED RT Downlight Dual Selectable luminaires are offered in 4", 6", 8" and 10" sizes and provide high performing light optimized for both new construction and retrofit applications where pin-based compact fluorescent lamps have previously been used. Installation is done quickly and easily in most standard frames. The CCT and lumen selectable switches on the base of the fixture allow for customizable light color temperature and adjustable lumen output, offering up to 36% energy savings when compared to traditional technologies. The luminaires are emergency battery back-up ready.

Benefits and Features

- Spinning aluminum construction
- CCT selectable light enabled through the switch located on the base of the product (4 light colors in the same product)
- Lumen selectable enabled through the switch located on the base of the product (3 lumen levels in the same product)
- ENERGY STAR® listed to maximize rebate opportunities
- Emergency Battery Backup Ready (field installable)
- Wet Rated
- Trim extenders available as accessories
- Up to 91 LPW
- CRI >90
- Uniform, glare free illumination
- Energy savings up to 36%

Electrical

- 120-277V_{AC} / 120-347V_{AC}
- Power Factor >0.9
- THD <20%
- 0-10V dimmable

Rated Life

- 50,000 hours (L₇₀)

Warranty

- 5-year
- NLB Trusted Warranty Program

Item #
Type
Project
Notes
Date

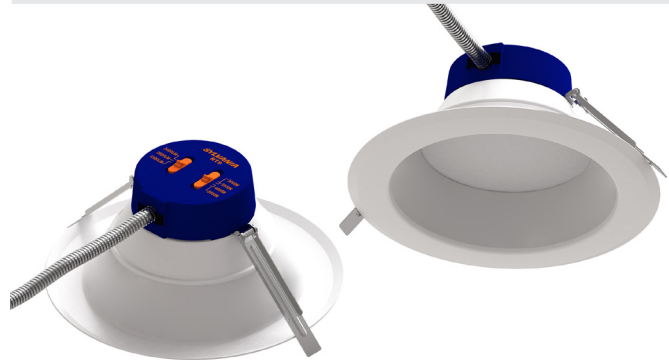

Wattage Comparison

Traditional Source	Traditional System Wattage	LED System Wattage	Energy Savings
Fluorescent	8-11-14W	7-8-9W	Up to 36%
Fluorescent	8-14-15W	7-9-11W	Up to 26%
Fluorescent	15-23-27W	14-18-24W	Up to 22%
Fluorescent	2x17-2x19-2x23W	25-29-35W	Up to 24%
Fluorescent	2x23-2x24-2x27W	32-37-43W	Up to 23%
Fluorescent	8-11-14W	7-9-12W	Up to 14%
Fluorescent	15-23-27W	10-18-23W	Up to 15%
Fluorescent	27-2x17-2x23W	20-28-34W	Up to 26%

Operating Temperature

- -4°F to +104°F (-20°C to +40°C)

Certifications and Listings

- cETLus
- RoHS
- FCC
- ENERGY STAR
- T24

Installation

Installation performed as a stand-alone kit (without frame) is recommended for hard ceiling. Installation of a recessed incandescent frame is recommended for tiled ceiling application for proper support of the retrofit kit.



Ordering Guide

RT	XX	SXXX	XXX	D	9	XX	5A
Product Name	Size	Selectable lumens	Voltage	Dimming	CRI	Color Temp	Generation
RT = LED	4 = 4"	700 = 500/600/700lm	UNV = 120-277V	D = 1-10V	9 = >90	27 = 2700K	5A = Downlight
Downlight	6 = 6"	900 = 500/700/900lm	UNH = 120-347V	dimmable		SC8 = Selectable	Generation
	8 = 8"	1000 = 600/800/1000lm				3000, 3500, 4000, 5000K or	
	10 = 10"	2000 = 900/1600/2000lm				2700, 3000, 3500, 4000K	
		2000 = 1100/1500/2000lm					
		3000 = 1850/2500/3000lm					
		3300 = 3400/2800/3300lm					
		4000 = 3000/3500/4000lm					

Ordering Information

Item Number	Ordering Abbreviation	Power (W)	Base Type	Traditional Replacement (W)	Input Voltage (V)	Average Life (hrs)	CCT	Typical Lumens (lm)	CRI	Power Factor	Bulb Finish	IC Rated	Case Qty	ENERGY STAR®	T24
65686	RT4S700UNVD9275A	7/8/9	Hardwire	8/11/14	120-277	50,000	2700K	500/600/700	>90	>90	Frosted	Yes	4	Yes	Yes
65687	RT4S700UNVD9SC85A	7/8/9	Hardwire	8/11/14	120-277	50,000	3000/3500/4000/5000K	500/600/700	>90	>90	Frosted	Yes	4	Yes	Yes
65688	RT6S900UNVD9275A	7/9/11	Hardwire	8/14/15	120-277	50,000	2700K	500/700/900	>90	>90	Frosted	Yes	4	Yes	Yes
65689	RT6S900UNVD9SC85A	7/9/11	Hardwire	8/14/15	120-277	50,000	3000/3500/4000/5000K	500/700/900	>90	>90	Frosted	Yes	4	Yes	Yes
65690	RT6S2000UNVD9SC85A	14/18/24	Hardwire	15/23/27	120-277	50,000	3000/3500/4000/5000K	1100/1500/2000	>90	>90	Frosted	No	4	Yes	Yes
65691	RT8S3300UNVD9SC85A	25/29/35	Hardwire	2x17/2x19/2x23	120-277	50,000	3000/3500/4000/5000K	2400/2800/3300	>90	>90	Frosted	No	4	Yes	Yes
65692	RT10S4000UNVD9SC85A	32/37/43	Hardwire	2x23/2x24/2x27	120-277	50,000	3000/3500/4000/5000K	3000/3500/4000	>90	>90	Frosted	No	4	Yes	Yes
65693	RT4S1000UNH9SC85A	7/9/12	Hardwire	8/11/14	120-347	50,000	2700/3000/3500/4000K	600/800/1000	>90	>90	Frosted	Yes	4	Yes	Yes
65694	RT6S2000UNH9SC85A	10/18/23	Hardwire	15/23/27	120-347	50,000	2700/3000/3500/4000K	900/1600/2000	>90	>90	Frosted	No	4	Yes	Yes
65695	RT8S3000UNH9SC85A	20/28/34	Hardwire	27/2x17/2x23	120-347	50,000	2700/3000/3500/4000K	1850/2500/3000	>90	>90	Frosted	No	4	Yes	Yes

Energy Savings

Basic Product Description	LED Life (hrs)	LED Lumens	Similar Incandescent (hrs)	Incandescent Lumens	Watts Saved	Energy Savings*	LED Life vs Incandescent
RT4S700UNVD9275A	50,000	500/600/700	2000	450/620/730	Up to 5	Up to 36%	25x
RT4S700UNVD9SC85A	50,000	500/600/700	2000	450/620/730	Up to 5	Up to 36%	25x
RT6S900UNVD9275A	50,000	500/700/900	2000	450/650/800	Up to 5	Up to 26%	25x
RT6S900UNVD9SC85A	50,000	500/700/900	2000	450/650/800	Up to 5	Up to 26%	25x
RT6S2000UNVD9SC85A	50,000	1100/1500/2000	2000	1000/1450/1900	Up to 5	Up to 22%	25x
RT8S3300UNVD9SC85A	50,000	2400/2800/3300	2000	2200/2900/3500	Up to 11	Up to 24%	25x
RT10S4000UNVD9SC85A	50,000	3000/3500/4000	2000	3800/3600/3900	Up to 11	Up to 23%	25x
RT4S1000UNH9SC85A	50,000	600/800/1000	2000	450/620/730	Up to 2	Up to 14%	25x
RT6S2000UNH9SC85A	50,000	900/1600/2000	2000	1000/1450/1900	Up to 5	Up to 15%	25x
RT8S3000UNH9SC85A	50,000	1850/2500/3000	2000	1900/2400/3100	Up to 12	Up to 26%	25x

*Energy savings over life of lamp calculated at \$0.11/kWh

Physical Information

Product Description	(A) Height (in)	(B) Diameter (in)
RT4S	3.65"	5.51"
RT6S	3.98"	7.36"
RT8S	4.35"	9.45"
RT10S	4.37"	11.26"

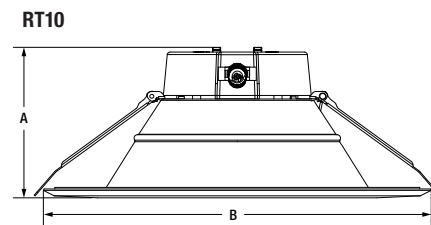
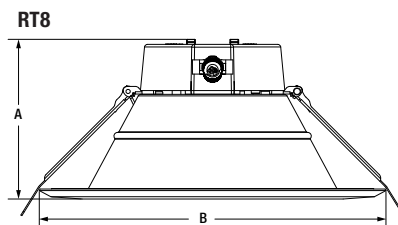
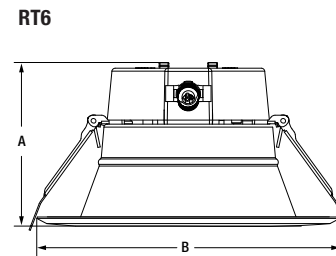
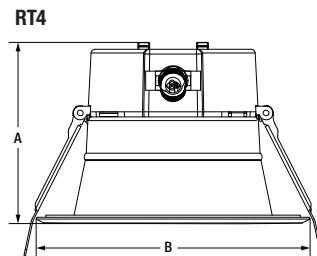

Photometric Data

LRT4S700UNVD9SC85AD

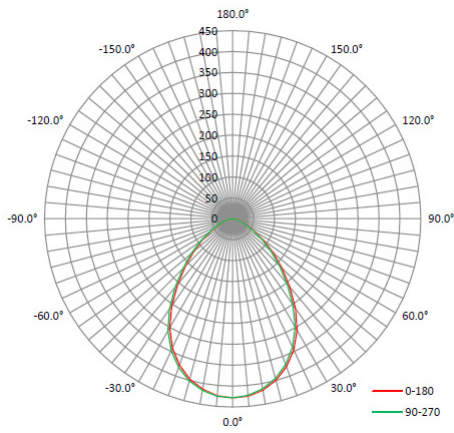

RT4S700UNVD9275A

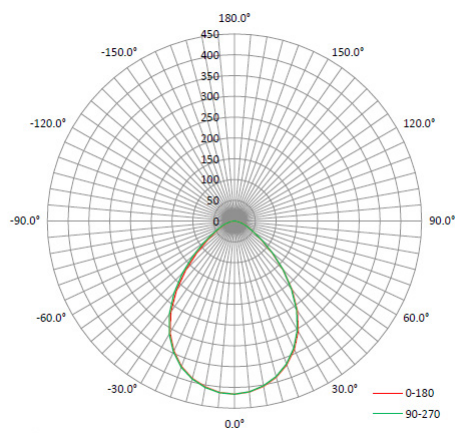

RT4S1000UNH9SC85A

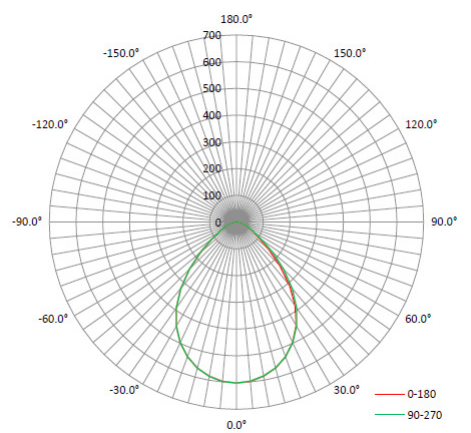

RT6S900UNVD9SC85A

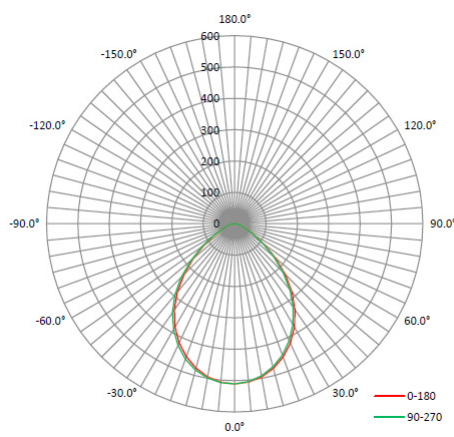

RT6S900UNVD9275A

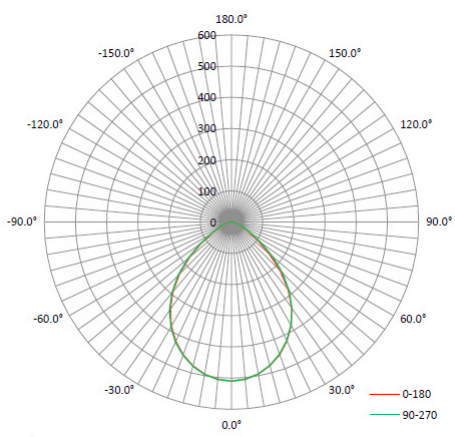

RT6S2000UNH9SC85A

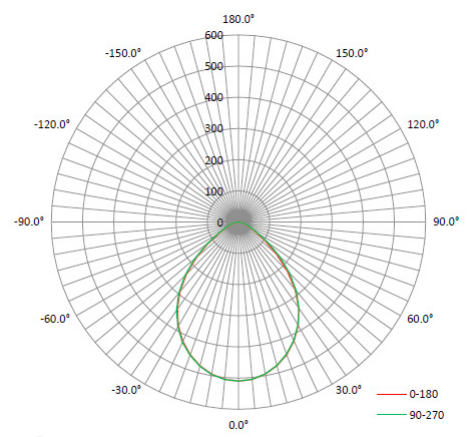

RT6S2000UNVD9SC85A

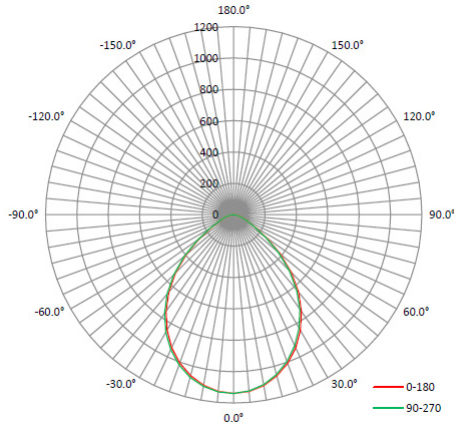

RT8S3000UNH9SC85A

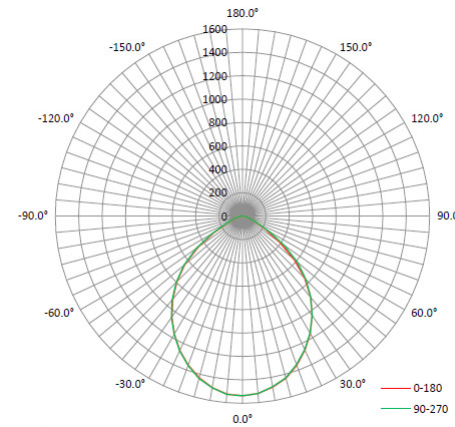

RT8S3300UNVD9SC85A

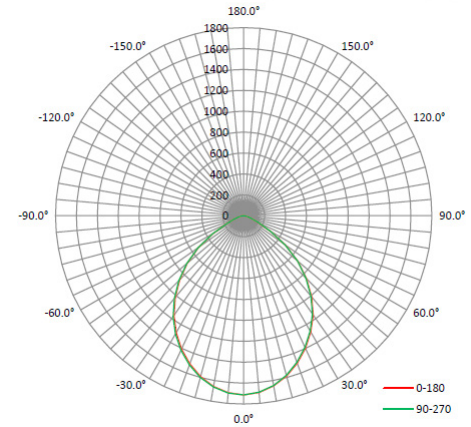

RT10S4000UNVD9SC85A

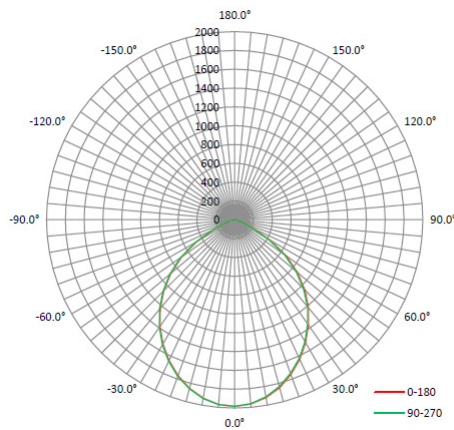

Accessories

Item Number	Ordering Abbreviation	Item Description
Trim Rings		
65710	RT4TRIM5ADKBZ	4" Bronze Trim Ring
65711	RT4TRIM5ASN	4" Satin Trim Ring
65712	RT4TRIM5ABLK	4" Black Trim Ring
65713	RT6TRIM5ADKBZ	6" Bronze Trim Ring
65714	RT6TRIM5ASN	6" Satin Trim Ring
65715	RT6TRIM5ABLK	6" Black Trim Ring
65716	RT8TRIM5ADKBZ	8" Bronze Trim Ring
65717	RT8TRIM5ASN	8" Satin Trim Ring
65718	RT8TRIM5ABLK	8" Black Trim Ring
65719	RT10TRIM5ADKBZ	10" Bronze Trim Ring
65720	RT10TRIM5ASN	10" Satin Trim Ring
65721	RT10TRIM5ABLK	10" Black Trim Ring

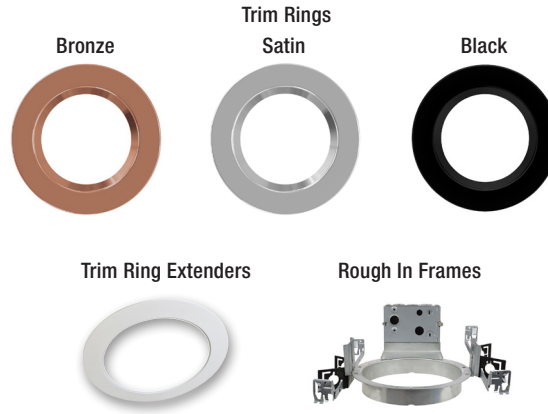

Trim Ring Extenders		
65683	RT68TRIMEXT5A	Trim extender for 8" cans
65684	RT810TRIMEXT5A	Trim extender for 10" cans
65685	RT812TRIMEXT5A	Trim extender for 12" cans
62366	RT1012TRIMEXT5A	Trim extender for 10" and 12" cans

RT5/6 Rough In Frame		
71708	LED/RT6HO/FRAME	6" recessed rough-in frame

RT8 Rough In Frame		
71709	LED/RT8/FRAME	8" recessed rough-in frame

Trim Ring Extender Dimensions

Product Description	(A) Outer Diameter in (mm)	(B) Inner Diameter in (mm)	(C) Thickness in (mm)
65683	9.44 (240.00)	5.44 (138.73)	0.375 (9.50)
65684	11.44 (290.80)	7.125 (180.75)	0.438 (10.50)
65685	13.44 (341.60)	7.125 (180.75)	0.438 (10.80)
62366	13.44 (341.60)	8.125 (205.83)	0.438 (10.80)

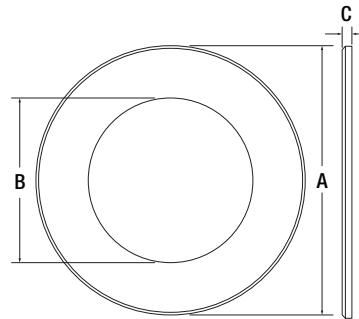

Emergency Battery Back-Up Accessories

For the EMBB application you must use the field-installable emergency back-up components listed below (sold separately).

Emergency Battery Back-Up Specs

NAED	Description	Input Voltage	Frequency	Input Current	Watt Hours	Max Mounting Height	Ambient Temp	Charging Time	Rating	Warranty
62367	EMBB2A8WUNVDC	100-277V _{AC}	50/60Hz	120mA Max	33.6Wh	21.6ft	0-50°C	24 hours	Damp	5 years
62368	EMBB2A8WUNHDC	100-347V _{AC}	50/60Hz	120mA Max	33.6Wh	21.6ft	0-50°C	24 hours	Damp	5 years

Description	(A) Length in (mm)	(B) Width in (mm)	(C) Height in (mm)
EMBB	12.9 (330)	2.6 (67)	2.2 (55)

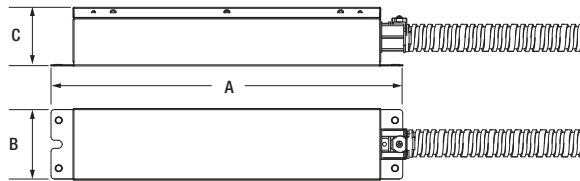

Compatibility Table

RT NAED	RT	NAED	EMBB Multi-listing	EMBB Wattage (W)*	EM Lumens (lm)*
65686	RT4S700UNVD9275A			8	700
65687	RT4S700UNVD9SC85A			8	700
65688	RT6S900UNVD9275A			11	900
65689	RT6S900UNVD9SC85A	62367/62368	EMBB2A8WUNVDC/ EMBB2A8WUNHDC	11	900
65690	RT6S2000UNVD9SC85A			13	1400
65691	RT8S3300UNVD9SC85A			13	1550
65692	RT10S4000UNVD9SC85A			13	1600
65693	RT4S1000UNH9SC85A			8	700
65694	RT6S2000UNH9SC85A	62368	EMBB2A8WUNHDC	13	1400
65695	RT8S3000UNH9SC85A			13	1550

*At the highest lumen level

EMBB Wiring Diagram

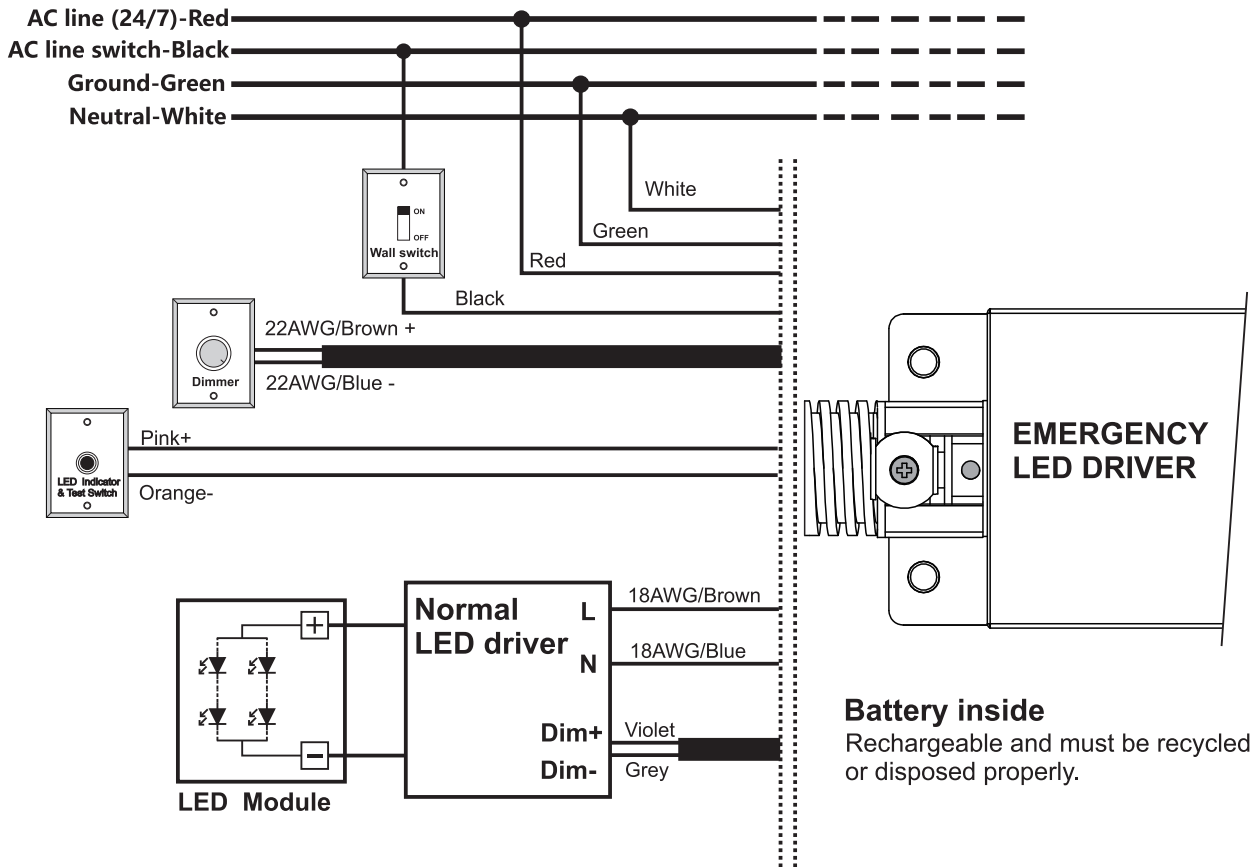

Hole Cut Templates

RT4 Hole Cut Template

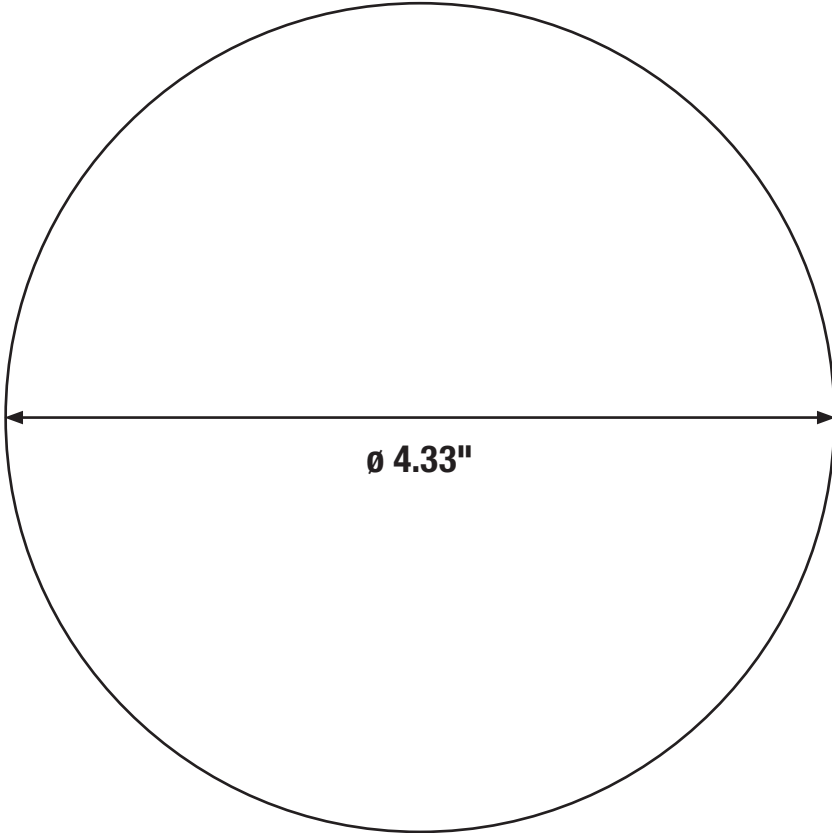

Hole Cut Templates

RT6 Hole Cut Template

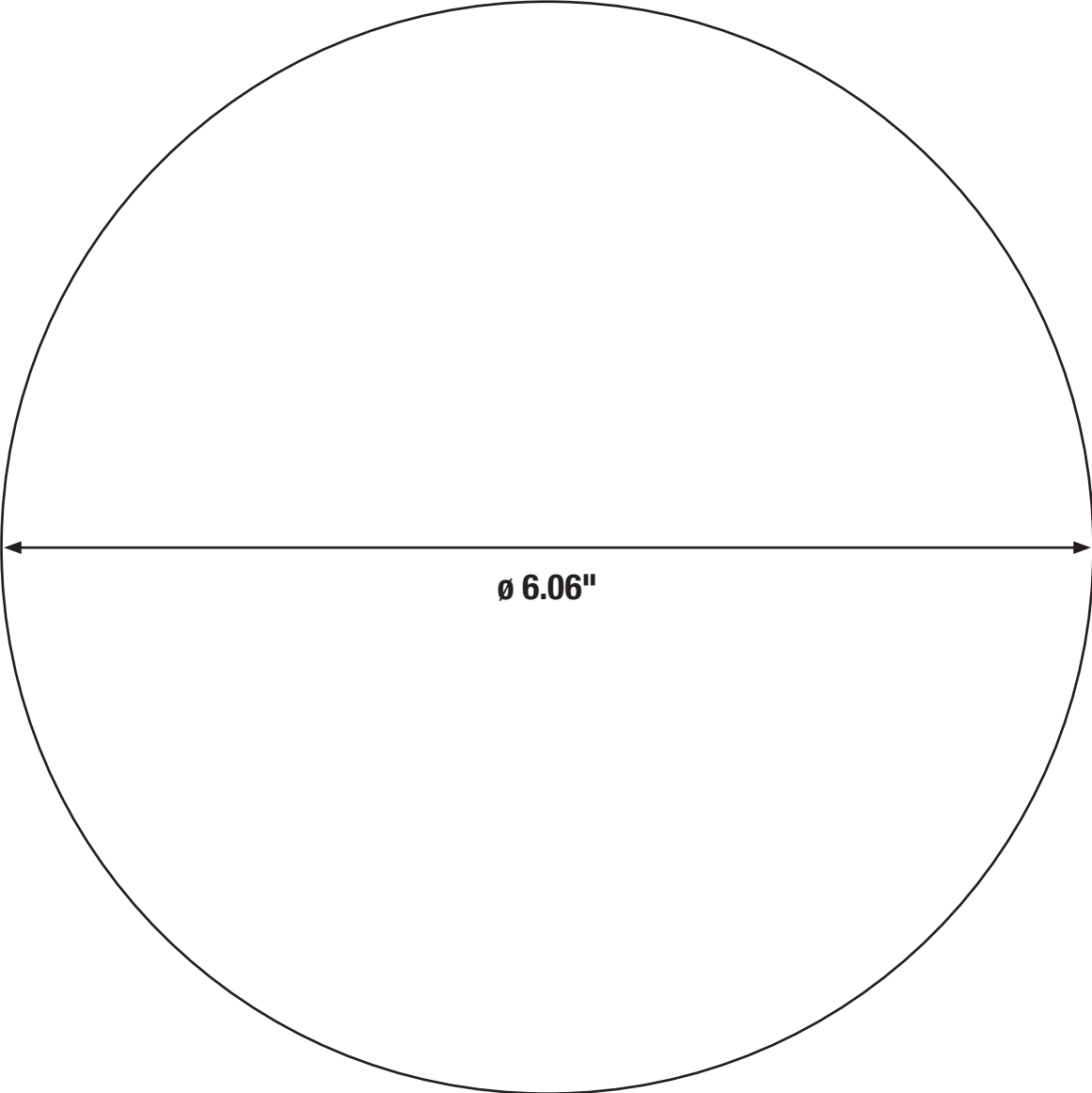

Hole Cut Templates

RT8 Hole Cut Template

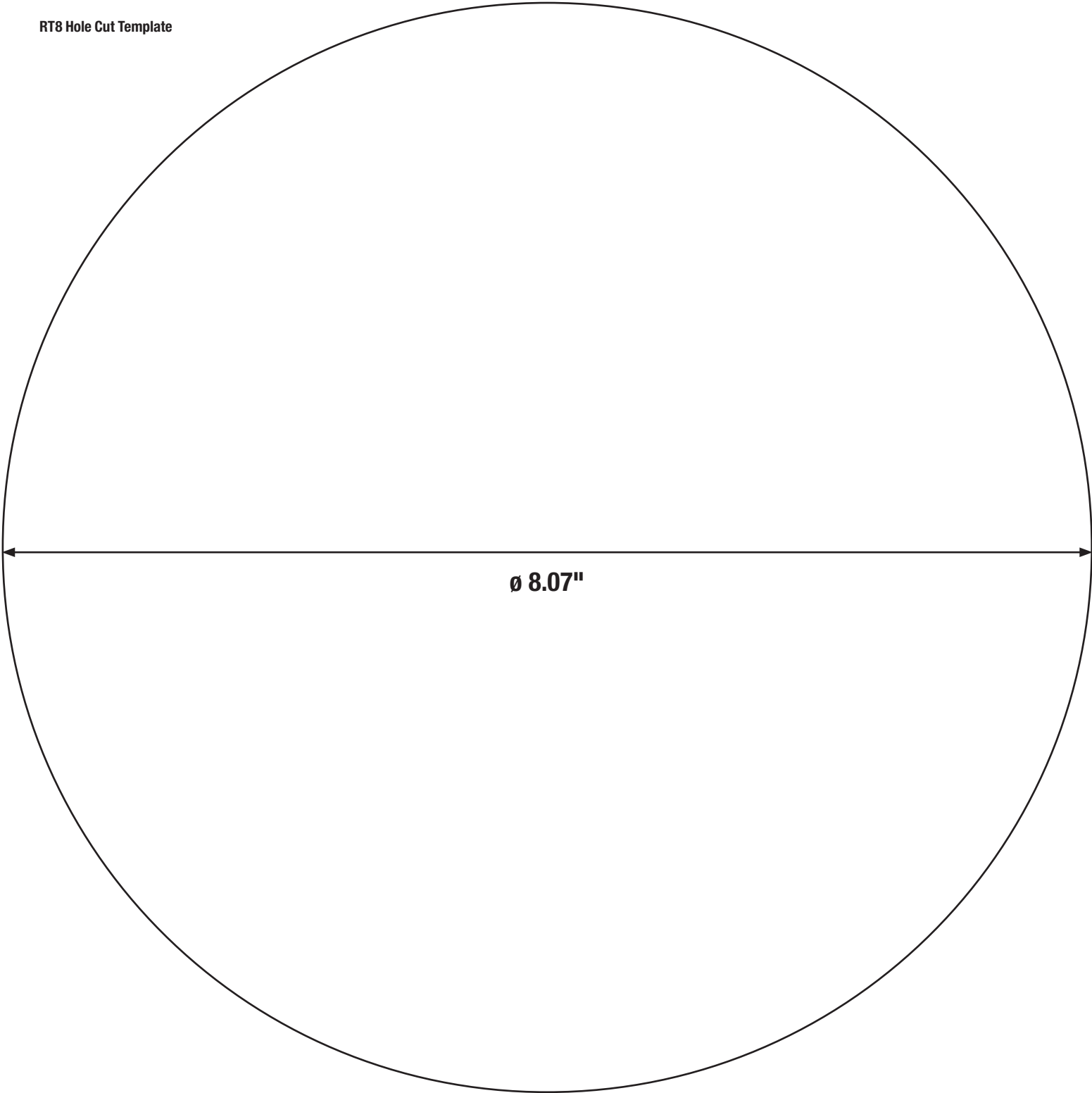

LEDVANCE LLC
200 Ballardvale Street
Wilmington, MA 01887 USA
Phone 1-800-LIGHTBULB (1-800-544-4828)
www.ledvanceUS.com

SYLVANIA and LEDVANCE are registered trademarks.
All other trademarks are those of their respective owners.
Licensee of product trademark SYLVANIA in general lighting.
Specifications subject to change without notice.

 /sylvania  /sylvania

Name:	<input type="text"/>
Email:	<input type="text"/>
Phone:	<input type="text"/>

