

Operation Instruction

— Direct Replacement



Product Name: LED T8 Tube Series
Input Voltage: Determined by fluorescent ballast
Product Model: 10T8/LED/36-8XX/DR
Product Models Included:
S29990-10T8/LED/36-830/DR
S29991-10T8/LED/36-835/DR
S29992-10T8/LED/36-840/DR
S29993-10T8/LED/36-850/DR

1. Product Features:

- UL certified
 - Plug-n-Play replacement
 - Full glass housing: No Aging, Yellowing, Bending.
 - Compatible with Instant Start, Program Start, Rapid Start T8 electronic ballast and Emergency ballast.
- May not be compatible with all ballasts, please visit www.satco.com for updated compatibility lists.

2. Product Applications:

Widely used in residential buildings, offices, shopping malls, supermarkets, hospitals, assembly lines, warehouses, etc. for energy saving illumination.

3. Installation Instructions:

Please completely comply with these instructions and notes, to ensure that the product is operated in a safe condition.

⚠ Safety Precautions:

- 1). WARNING: Risk of shock. Disconnect power before installation.
- 2). LED T8 lamp for use only with products described and installed in accordance with product specifications. LED T8 lamp to be operated with fluorescent electronic ballast and Emergency ballast.
- 3). WARNING: RISK OF FIRE, USE ONLY IN PLACE OF FLUORESCENT LAMPS SPECIFIED ON LABEL. RISK OF ELECTRIC SHOCK. SUITABLE FOR DAMP LOCATIONS.

INSTALLATION INSTRUCTIONS

1) Make Sure Power is OFF

2) Remove lens or diffuser (if applicable)

3) Remove existing fluorescent lamps from the luminaire.

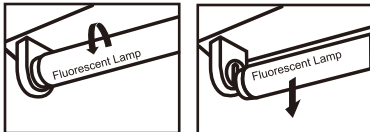

4) Bring LED lamp to luminaire and insert lamp pins into luminaire lamp holders.

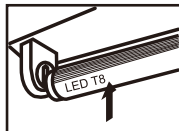

5) Rotate LED lamp until lamp locks in place. Ensure that the LED lamp front points away from the back of the luminaire.

Note: install LED T8 replacement lamp one for each fluorescent lamp removed.

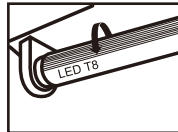

6) Place lens or diffuser back in place (if applicable)

7) Power ON

Instant Start Ballast Wiring Diagram(**Correct**)

Two Lamps Ballast Correct Wiring

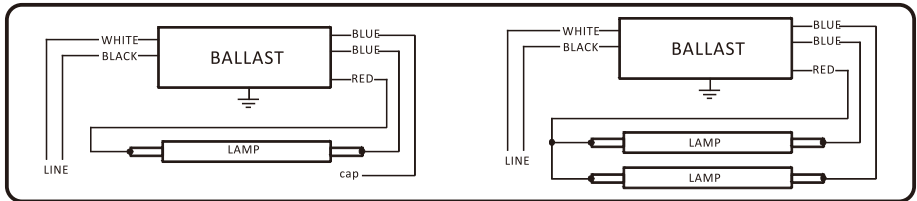

Three Lamps Ballast Correct Wiring

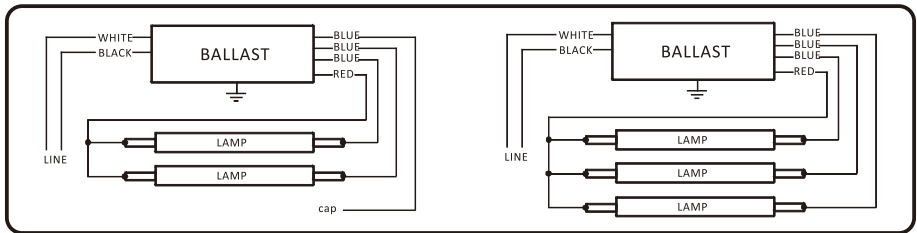

Four Lamps Ballast Correct Wiring

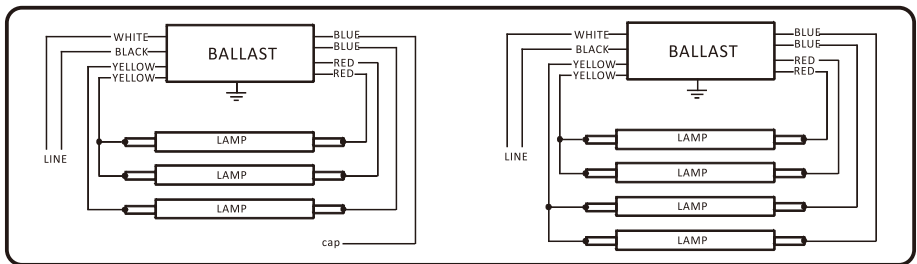

Instant Start Ballast Wiring Diagram(**Incorrect**)

Two Lamps Ballast Incorrect Wiring

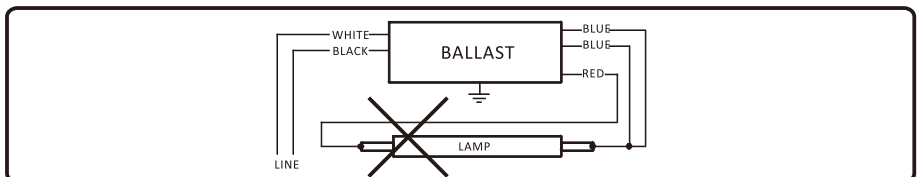

Instant Start Ballast Wiring Diagram (Incorrect)

Three Lamps Ballast Incorrect Wiring

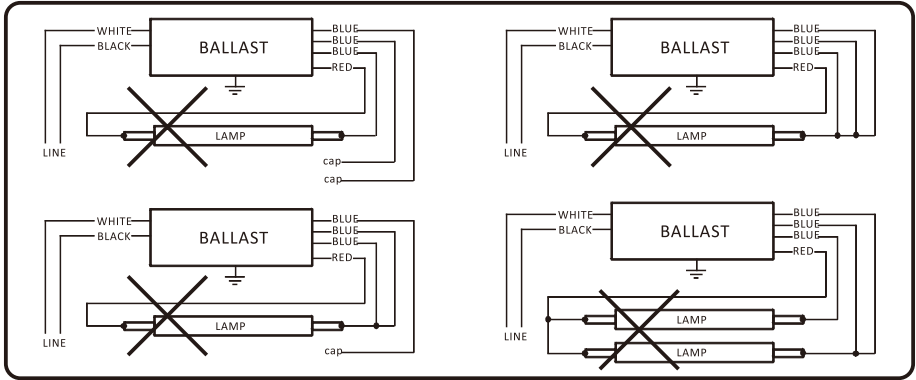

Four Lamps Ballast Incorrect Wiring

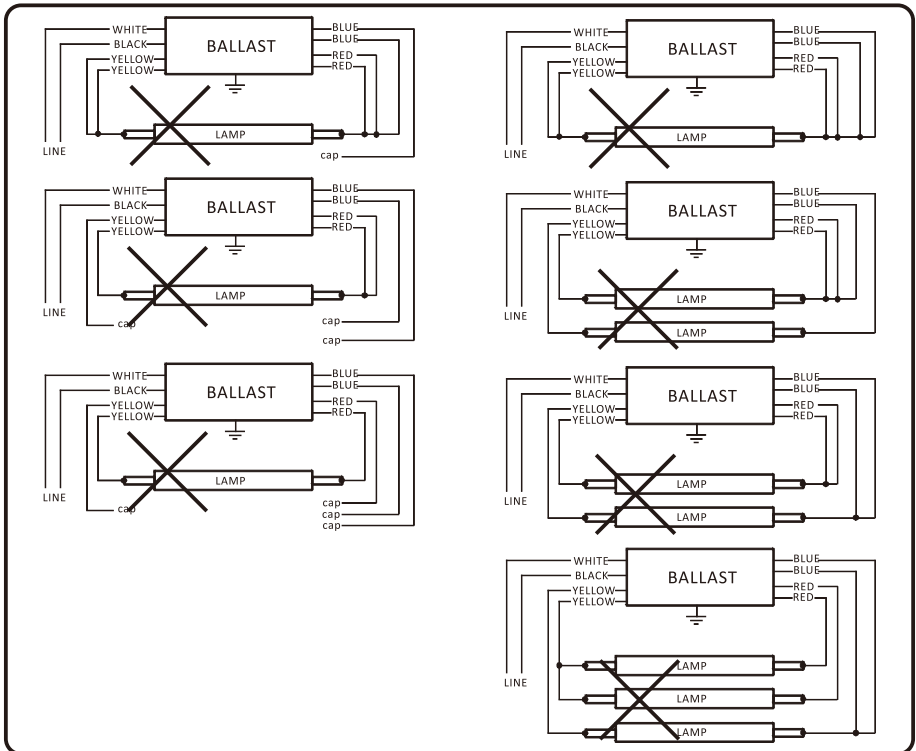

DO NOT INSTALL THIS LAMP IN A PRE - HEAT LUMINAIRE.

N'INSTALLEZ PAS CETTE LAMPE DANS UN APPAREIL D'ÉCLAIRAGE DE PRÉCHAUFFAGE.

THIS LAMP ONLY OPERATES ON ELECTRONIC BALLASTS. IF LAMP DOES NOT LIGHT WHEN THE LUMINAIRE IS ENERGIZED, REMOVE LAMP FROM LUMINAIRE AND CONTACT LAMP MANUFACTURER OR QUALIFIED ELECTRICIAN.

CETTE LAMPE OPERE SEULEMENT AVEC LE BALLAST ELECTRONIQUE. SI LA LAMPE NE S'ALLUME PAS QUAND L'APPAREIL D'ECLAIRAGE ACTIVE, ENLEVEZ LA LAMPE DE L'APPAREIL D'ECLAIRAGE ET CONTACTEZ LE FABRICANT DE LAMPE OU UN ELECTRICIEN QUALIFIE.

CAUTION RISK OF FIRE - IF THE LAMP OR LUMINAIRE EXHIBITS UNDESIRABLE OPERATION (BUZZING, FLICKERING, ETC.), IMMEDIATELY TURN OFF POWER, REMOVE LAMP FROM LUMINAIRE AND CONTACT MANUFACTURER.

ATTENTION RISQUE DE FEU - SI LA LAMPE OU LE LUMINAIRE MONTRE DES SIGNES D'OPERATION INDESIRABLE (BRUIT, VIBRATION, CLIGNOTEMENT, ETC.), ALORS COUPER IMMÉDIATEMENT LE COURANT ET ENLÈVER LA LAMPE DE L'APPAREIL D'ÉCLAIRAGE ENTRER EN CONTACT AVEC LE FABRICANT.

4. Safety Information:

- (1) Check the lamp before installation, if there is any damage caused during transportation, do not install.
- (2) Maintenance should be carried out by technical personnel only.
- (3) Do not stare at the light source with bare eyes for a long time, or beam to others' eyes.
- (4) Do not place any objects on the lamp.
- (5) Keep the lamp away from flame or high temperature objects.
- (6) Only replace with same type of LED tube! Risk of electrical shock!
- (7) If the glass lamp tube is broken, the lamp must be disposed of immediately!

5. Maintenance Notes

- (1) Disconnect lamp from power supply before any maintenance.
- (2) Clean luminaire with dry cloth.
- (3) Do not clean the lamp with corrosive chemicals.
- (4) FOR EMERGENCY LIGHTING WHEN ONLY WITH Ballast - Listed (FTBR/7), PHILIPS EMERGENCY LIGHTING (E49328), Model B50 (Alternate RS), Rated 120/277V, 50/60Hz, Damp Location Fluorescent Emergency Ballast.

This device complies with Part 15 of the FCC Rules. Operation is subject to the following two conditions:
(1) this device may not cause harmful interference,
and (2) this device must accept any interference received, including interference that may cause undesired operation.

Satco Products, Inc
110 Heartland Blvd. Brentwood, NY 11717
www.satco.com