



ONE PIECE AIR DIFFUSERS

## Our patented 73 second



- Patented one piece grille, damper box.
- Virtually air tight.
- Lightening fast installation.

Virtually air tight butterfly damper  
Rubber gasket delivers superior  
seal when closed.

Stepped Collar for  
multiple duct sizes ▶

Collar tabs easily tear away  
unnneeded sections ▶



Mounting Clip  
accommodate  
thicknesses up to 1/4"

Damper Handle  
allows smooth, easy turning  
adjustment from below  
for fully open to tightly  
closed position ▶

▲ High Grade Polymer Grille  
resists breakage, scratching,  
yellowing and fading.

# diffuser install is the quickest in the trade.



C H O O S E   C L A S S I C   O R   R E T R O   S T Y L E



## **Classic** GRILLE DAMPER BOX

**Think fast Work smart.** Our one piece design is virtually air tight, eliminating the need for tedious mastic and external sealers. That cuts attic time. Diffuser installation is no longer a two man job. Labor estimates will be more competitive and you can pocket the profit. You won't want to go back to a metal diffuser ever again.

### **Strong, Versatile, Quiet.**

TRUaire Retrofit Classic is molded with professional grade polymers for long lasting durability. Choose from five grille styles to deliver the optimum air flow and movement pattern for any room. Stepped collar tears off easily to enlarge duct size to maximize job site flexibility. Virtually air-tight construction ensures efficient and quiet air delivery. 2 Sizes available.



## **Retro** GRILLE DAMPER BOX

**Retro style. Same innovation.** Something unexpectedly beautiful for your discriminating customer. Retro diffusers simulate the look of traditional cast iron, to add a sense of warmth missing in contemporary diffusers.

### **For Premium Installations.**

Distinguish yourself from your competition with TRUaire Retrofit Retro reproduction antique styled air diffusers. Your discerning customer can have the look and feel of a reproduction cast iron grille without the high cost and weight. Simulated cast iron texturing is scratch and rust resistant. Authentic handle turns easily for full range of air flow adjustment. TRUaire Retrofit Retro offers the same advanced technology and labor saving installation time as the standard TRUaire Retrofit diffuser line. Available in black and white. 2 sizes available.

Action videos and full details @ [rectorseal.com/airtec](http://rectorseal.com/airtec)

# TRUAIRE® RETROFIT DIFFUSER AIR FLOW SPECIFICATIONS



2-way  
Antique

3-way

4-way

Round

Return/exhaust

**RS # (ref. #)**

**81912 (MV2)** (8x8") Ak=.33

CFM	PRESSURE LOSS	THROW*	FACE VELOCITY**
55	.006 WG	4.9 ft	164 ft/min
75	.009 WG	6.7 ft	229 ft/min
90	.014 WG	8.0 ft	264 ft/min
110	.021 WG	9.8 ft	330 ft/min
125	.027 WG	11.1 ft	375 ft/min
150	.039 WG	13.4 ft	451 ft/min
175	.053 WG.	15.6 ft	533 ft/min
200	.069 WG	17.8 ft	604 ft/min
250	.108 WG	22.3 ft	757 ft/min
300	.156 WG	26.7 ft	909 ft/min
350	.212 WG	31.2 ft	1060 ft/min



**RS # (ref. #)**

**81902 (MV2S)** (6x6") Ak=.17

CFM	PRESSURE LOSS	THROW*	FACE VELOCITY**
55	.028 WG	4.5 ft	308 ft/min
75	.054 WG	6.0 ft	421 ft/min
90	.102 WG	7.1 ft	592 ft/min
110	.145 WG	8.9 ft	663 ft/min
125	.181 WG	10.3 ft	785 ft/min
150	.245 WG	11.5 ft	903 ft/min
175	.325 WG.	12.6 ft	1045 ft/min
200	.430 WG	14.0 ft	1155 ft/min

**RS # (ref. #)**

**81913 (MV3), 81943 (GRD3)** (8x8") Ak=.29

CFM	PRESSURE LOSS	THROW*	FACE VELOCITY**
55	.008 WG	5.0 ft	188 ft/min
75	.014 WG	6.8 ft	255 ft/min
90	.020 WG	8.1 ft	310 ft/min
110	.030 WG	9.9 ft	370 ft/min
125	.038 WG	11.3 ft	445 ft/min
150	.054 WG	13.5 ft	517 ft/min
175	.073 WG.	15.8 ft	602 ft/min
200	.095 WG	18.0 ft	689 ft/min
250	.148 WG	22.5 ft	862 ft/min
300	.213 WG	27.0 ft	1034 ft/min
350	.289 WG	31.5 ft	1206 ft/min



Throw measurements are equal in all three directions +/-5%

**RS # (ref. #)**

**81903 (MV3S)** (6x6") Ak=.17

CFM	PRESSURE LOSS	THROW*	FACE VELOCITY**
55	.056 WG	5.3 ft	344 ft/min
75	.075 WG	7.2 ft	426 ft/min
90	.130 WG	8.8 ft	570 ft/min
110	.171 WG	10.2 ft	661 ft/min
125	.230 WG	11.1 ft	785 ft/min
150	.290 WG	11.5 ft	880 ft/min
175	.445 WG.	12.1 ft	994 ft/min
200	.545 WG	12.8 ft	1182 ft/min

**RS # (ref. #)**

**81914 (MV4), 81944 (GRD4) & 81834 (GR4)** (8x8") Ak=.30

CFM	PRESSURE LOSS	THROW*	FACE VELOCITY**
55	.007 WG	3.9 ft	183 ft/min
75	.011 WG	5.3 ft	247 ft/min
90	.017 WG	6.4 ft	293 ft/min
110	.024 WG	7.8 ft	359 ft/min
125	.030 WG	8.9 ft	410 ft/min
150	.043 WG	10.6 ft	505 ft/min
175	.057 WG.	12.4 ft	562 ft/min
200	.073 WG	14.2 ft	640 ft/min
250	.114 WG	17.7 ft	833 ft/min
300	.164 WG	21.3 ft	1000 ft/min
350	.223 WG	24.8 ft	1166 ft/min



**RS # (ref. #)**

**81904 (MV4S)** (6x6") Ak=.20

CFM	PRESSURE LOSS	THROW*	FACE VELOCITY**
55	.050 WG	4.5 ft	330 ft/min
75	.085 WG	6.3 ft	361 ft/min
90	.117 WG	7.1 ft	440 ft/min
110	.160 WG	8.2 ft	527 ft/min
125	.200 WG	9.1 ft	605 ft/min
150	.290 WG	10.2 ft	750 ft/min
175	.395 WG.	10.9 ft	875 ft/min
200	.490 WG	11.5 ft	962 ft/min

**RS # (ref. #)**

**81911 (MV360)**(8x8") Ak=.33

CFM	PRESSURE LOSS	THROW*	FACE VELOCITY**
55	.002 WG	3.0 ft	161 ft/min
75	.003 WG	3.6 ft	223 ft/min
90	.004 WG	3.8 ft	269 ft/min
110	.005 WG	4.0 ft	328 ft/min
125	.006 WG	5.0 ft	381 ft/min
150	.010 WG	5.5 ft	449 ft/min
175	.015 WG.	6.5 ft	527 ft/min
200	.021 WG	7.0 ft	612 ft/min
250	.029 WG	8.0 ft	755 ft/min
300	.038 WG	9.0 ft	904 ft/min
350	.045 WG	10.0 ft	1055 ft/min



**RS # (ref. #)**

**81901 (MV360S) S** (6x6") Ak=.17

CFM	PRESSURE LOSS	THROW*	FACE VELOCITY**
55	.006 WG	0.8 ft	214 ft/min
75	.009 WG	1.5 ft	284 ft/min
90	.014 WG	2.2 ft	347 ft/min
110	.018 WG	2.3 ft	415 ft/min
125	.025 WG	3.2 ft	437 ft/min
150	.036 WG	4.4 ft	544 ft/min
175	.045 WG.	5.5 ft	614 ft/min
200	.060 WG	6.4 ft	699 ft/min

\*All throw measurements are made from the center of the grille to a terminal velocity of 50 feet per minute. Direction determined by grille profile.

\*\*Noise level of any diffuser is directly related to face velocity. As a general rule face velocity should be under 800 FPM for residential applications. The MV diffuser with its one piece molded design, outperforms comparable diffusers causing less turbulence and noise.

# TRUAIRE® RETROFIT DIFFUSER AIR FLOW SPECIFICATIONS



**RS # (ref. #)**  
**81915 (MVE)** (8x8") Ak=.37

CFM	PRESSURE LOSS	THROW*	FACE VELOCITY**
55	.0005 WG	0.8 ft	92 ft/min
75	.0008 WG	2.1 ft	151 ft/min
90	.0014 WG	3.4 ft	207 ft/min
110	.0017 WG	5.6 ft	255 ft/min
125	.0020 WG	7.8 ft	350 ft/min
150	.0030 WG	9.7 ft	445 ft/min
175	.0050 WG.	11.4 ft	545 ft/min
200	.0080 WG	12.8 ft	700 ft/min
250	.0200 WG	14.1 ft	910 ft/min
300	.0250 WG	14.8 ft	1044 ft/min
350	.0300 WG	15.4 ft	1187 ft/min



**RS # (ref. #)**  
**81905 (MVES)** (6x6") Ak=.31

CFM	PRESSURE LOSS	THROW*	FACE VELOCITY**
55	.0008 WG	1.2 ft	146 ft/min
75	.0018 WG	4.2 ft	230 ft/min
90	.0035 WG	6.2 ft	285 ft/min
110	.0043 WG	7.3 ft	338 ft/min
125	.0054 WG	8.7 ft	434 ft/min
150	.0085 WG	9.8 ft	545 ft/min
175	.0100 WG.	11.0 ft	645 ft/min
200	.0110 WG	12.4 ft	685 ft/min

**RS # (ref. #)**  
**81916 (MXE)** (8x8") Ak=.37

CFM	PRESSURE LOSS	THROW*	FACE VELOCITY**
55	.0005 WG	0.8 ft	92 ft/min
75	.0008 WG	2.1 ft	151 ft/min
90	.0014 WG	3.4 ft	207 ft/min
110	.0017 WG	5.6 ft	255 ft/min
125	.0020 WG	7.8 ft	350 ft/min
150	.0030 WG	9.7 ft	445 ft/min
175	.0050 WG.	11.4 ft	545 ft/min
200	.0080 WG	12.8 ft	700 ft/min
250	.0200 WG	14.1 ft	910 ft/min
300	.0250 WG	14.8 ft	1044 ft/min
350	.0300 WG	15.4 ft	1187 ft/min



**RS # (ref. #)**  
**81906 (MXES)** (6x6") Ak=.31

CFM	PRESSURE LOSS	THROW*	FACE VELOCITY**
55	.0008 WG	1.2 ft	146 ft/min
75	.0018 WG	4.2 ft	230 ft/min
90	.0035 WG	6.2 ft	285 ft/min
110	.0043 WG	7.3 ft	338 ft/min
125	.0054 WG	8.7 ft	434 ft/min
150	.0085 WG	9.8 ft	545 ft/min
175	.0100 WG.	11.0 ft	645 ft/min
200	.0110 WG	12.4 ft	685 ft/min

**RS # (ref. #)**  
**81909 (MVAW)** (8x8") Ak=.26

CFM	PRESSURE LOSS	THROW*	FACE VELOCITY**
55	.0007 WG	4.0 ft	175 ft/min
75	.0009 WG	6.8 ft	269 ft/min
90	.0021 WG	8.2 ft	383 ft/min
110	.0055 WG	9.9 ft	436 ft/min
125	.0064 WG	11.3 ft	472 ft/min
150	.0085 WG	12.9 ft	593 ft/min
175	.0105 WG.	14.3 ft	693 ft/min
200	.0160 WG	15.3 ft	841 ft/min
250	.0230 WG	16.0 ft	1031 ft/min
300	.0391 WG	17.2 ft	1201 ft/min
350	.0552 WG	17.9 ft	1315 ft/min

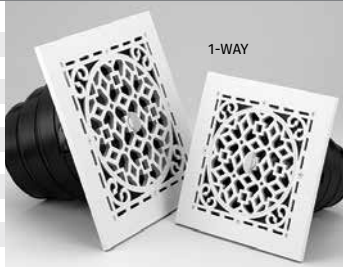

**RS # (ref. #)**  
**81919 (MVASW)** (6x6") Ak=.20

CFM	PRESSURE LOSS	THROW*	FACE VELOCITY**
55	.0085 WG	2.1 ft	277 ft/min
75	.0185 WG	5.0 ft	373 ft/min
90	.0240 WG	7.9 ft	445 ft/min
110	.0375 WG	10.9 ft	550 ft/min
125	.0520 WG	13.3 ft	650 ft/min
150	.0730 WG	14.9 ft	771 ft/min
175	.1010 WG.	16.3 ft	899 ft/min
200	.1200 WG	17.5 ft	988 ft/min

**RS # (ref. #)**  
**81918 (MVAB)** (8x8") Ak=.26

CFM	PRESSURE LOSS	THROW*	FACE VELOCITY**
55	.0007 WG	4.0 ft	175 ft/min
75	.0009 WG	6.8 ft	269 ft/min
90	.0021 WG	8.2 ft	383 ft/min
110	.0055 WG	9.9 ft	436 ft/min
125	.0064 WG	11.3 ft	472 ft/min
150	.0085 WG	12.9 ft	593 ft/min
175	.0105 WG.	14.3 ft	693 ft/min
200	.0160 WG	15.3 ft	841 ft/min
250	.0230 WG	16.0 ft	1031 ft/min
300	.0391 WG	17.2 ft	1201 ft/min
350	.0552 WG	17.9 ft	1315 ft/min



**RS # (ref. #)**  
**81908 (MVASB)** (6x6") Ak=.20

CFM	PRESSURE LOSS	THROW*	FACE VELOCITY**
55	.0085 WG	2.1 ft	277 ft/min
75	.0185 WG	5.0 ft	373 ft/min
90	.0240 WG	7.9 ft	445 ft/min
110	.0375 WG	10.9 ft	550 ft/min
125	.0520 WG	13.3 ft	650 ft/min
150	.0730 WG	14.9 ft	771 ft/min
175	.1010 WG.	16.3 ft	899 ft/min
200	.1200 WG	17.5 ft	988 ft/min

Note: Supply diameter has no appreciable effect on characteristics or airflow specifications, but should be consistent with the desired airflow of the particular outlet and application. Instruments used in testing: • Shortridge Instruments Flowhood Series 8400 • Shortridge Instruments Air data Multimeter • Davis LCA-6000 Rotating Vane Anemometer

# TRUAIRE® RETROFIT CLASSIC/RETRO ORDERING INFORMATION



2-way Antique    3-way    4-way    Round    Return/exhaust

**Note:** Stepped Collar accommodates:  
6", 7", 8" ducting (MV)    4", 5", 6" ducting (MVS)

## TRUAire Retrofit Classic standard 8x8" diffuser assembly

RS # (ref. #)	DESCRIPTION	CTN QTY	CTN WT
81912 (MV2)	2-way grille/damper/box	4	9 lbs.
81913 (MV3)	3-way grille/damper/box	4	9 lbs.
81914 (MV4)	4-way grille/damper/box	4	9 lbs.
81911 (MV360)	Round grille/damper/box	4	9 lbs.
81915 (MVE)	Return/exhaust grille/damper/box	4	9 lbs.
81916 (MXE)	Return/exhaust grille/box (no damper)	4	9 lbs.

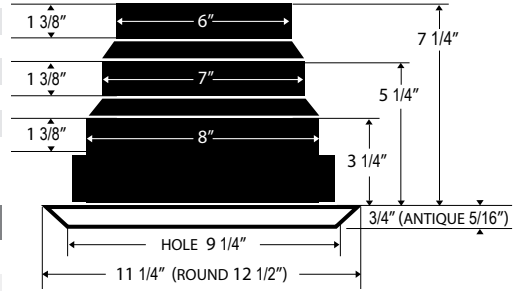

## TRUAire Retrofit Retro standard 8x8" diffuser assembly

RS # (ref. #)	DESCRIPTION	CTN QTY	CTN WT
81909 (MVAW)	Retro White grille/damper/box	4	9 lbs.
81918 (MVAB)	Retro Black grille/damper/box	4	9 lbs.

## TRUAire Retrofit Classic small 6x6" diffuser assembly

RS # (ref. #)	DESCRIPTION	CTN QTY	CTN WT
81902 (MV2S)	2-way grille/damper/box	8	10.5 lbs.
81903 (MV3S)	3-way grille/damper/box	8	10.5 lbs.
81904 (MV4S)	4-way grille/damper/box	8	10.5 lbs.
81901 (MV360S)	Round grille/damper/box	6	7.5 lbs.
81905 (MVES)	Return/exhaust grille/damper/box	8	10.5 lbs.
81906 (MXES)	Return/exhaust grille/box (no damper)	8	10.5 lbs.

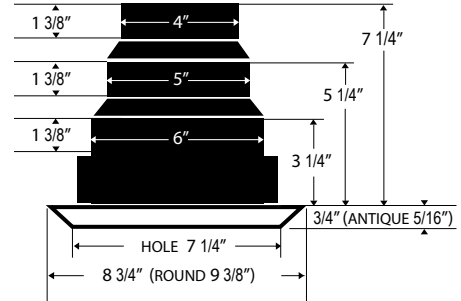

## TRUAire Retrofit Retro small 6x6" diffuser assembly

RS # (ref. #)	DESCRIPTION	CTN QTY	CTN WT
81919 (MVASW)	Retro White grille/damper/box	8	10.5 lbs.
81908 (MVASB)	Retro Black grille/damper/box	8	10.5 lbs.

## Limited clearance grille/damper

RS # (ref. #)	DESCRIPTION	CTN QTY	CTN WT
81943 (GRD3)	3-way grille/damper	12	15.8 lbs.
81944 (GRD4)	4-way grille/damper	12	15.8 lbs.

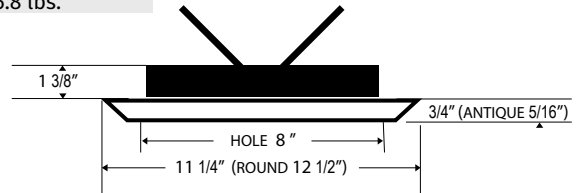

## Standard Limited clearance grille only

RS # (ref. #)	DESCRIPTION	CTN QTY	CTN WT
81834 (GR4)	4-way grille	25	6 lbs.

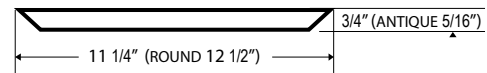



## TRUAIRE® RETROFIT ACCESSORIES

### GRD Limited Clearance Diffusers

**Model GRD** grille/damper combination for low clearance side or top entry applications. Same construction as TRUAire Retrofit diffusers but with no boot. Standard 8" size only. Available in all five grille styles.

See page 90 for ordering information.

#### Grille with damper



### GR Classic/Retro Grilles

**Model GR** grille only. All styles and sizes of both TRUAire Retrofit Classic and TRUAire Retrofit Retro grilles are available. Does not include boot or damper.

See page 90 for ordering information.

#### Grille only

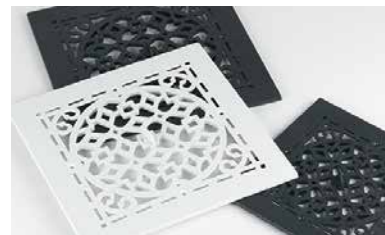

### RCF Ceiling Support Flanges

RS # (ref. #)	Description	L	W	H	CTN QTY	CTN WT
81965 (RCF16)	16"O/C - 9 <sup>1</sup> / <sub>4</sub> " hole	16"	12"	3/8"	50	37 lbs.
81964 (RCF24)	24"O/C - 9 <sup>1</sup> / <sub>4</sub> " hole	23 <sup>5</sup> / <sub>8</sub> "	12"	3/8"	25	38 lbs.
81955 (RCF16S)	16"O/C - 7" hole	16"	12"	3/8"	50	48 lbs.
81954 (RCF24S)	24"O/C - 7" hole	23 <sup>5</sup> / <sub>8</sub> "	12"	3/8"	25	39 lbs.

**Model RCF** designed for new construction. Our RCF flanges can be fastened to rough framing. It has a 3/8" lip that drops below the ceiling, requiring dry wall installers to cut the hole for you. RCF flanges are available for both 16" and 24" on center framing.

#### Rough in flanges



### DCF Drop Ceiling Flanges

RS # (ref. #)	Description	L	W	H	CTN QTY	CTN WT
81963 (DCF)	24"O/C - 9 <sup>1</sup> / <sub>4</sub> " hole	23 <sup>5</sup> / <sub>8</sub> "	12"	2"	25	45 lbs.

**Model DCF** will increase strength and performance for lay in type ceiling applications by transferring weight onto the T-bars. This prevents tiles from sagging over time.

#### Flange only





## TRUAIRE® RETROFIT TUFFBOX AIR DIFFUSERS

### TRUaire Retrofit TuffBox

Quick rough-in polymer register box

Code	Description	CTN QTY	CTN WT
81966 (MHS)	6x6" Register Box 4,5,6" collars	16	15 lbs.
81968 (MH)	8x8" Register Box 6,7,8" collars	10	12.2 lbs.
81970 (MHL)	10x10" Register Box 8,9,10" collars	8	12 lbs.



Our TuffBox is a heavy, one piece durable polymer shell. Molded design is virtually airtight to deliver 100% of the air flow passing through it.

Each TuffBox utilizes innovative stepped design to accommodate three duct sizes. Quick breakaway collars allow on-site adjustment, and labor savings. Each collar is 1-3/8" and beaded to hold flexible duct in place while strap is secured. 5/8" standoffs provide correct depth to accommodate strapping or furring used with drywall. Secure using screw holes provided or simply screw anywhere through the inside into framing. Flange is flexible to conform to drywall backing virtually eliminating leakage between grille and box.

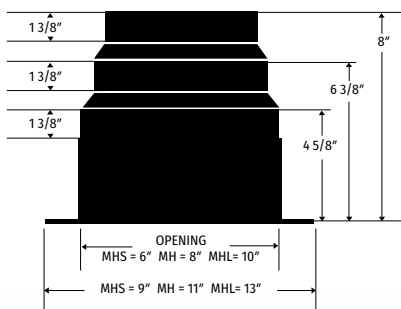

- Adaptable.
- Strong & Silent.
- No measuring.
- No guesswork.