

7584

120V

Catalog #:		Type
Project:		Date
Prepared by:		

120V LED Track Head Track Lighting

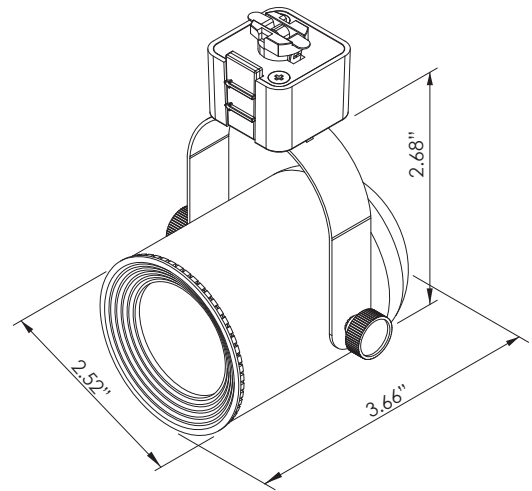

DESCRIPTION

Clean and cool, simple attractive aesthetics with functionality providing an abundance of light for your interior space. This track light can be turned and tilted - an ideal choice for almost any interior space, great for residential kitchens, bars, and hospitality applications.

DESIGN FEATURES

Construction

- Durable steel construction with acrylic lens
- Durable aluminum extrusion heat sink with intergrated COB (chip on board)
- 40° beam angle
- Compatible with Juno style track
- Dry Environment, Indoor

Electrical

- Operating voltage AC120V
- Operating temperature 140°F (60°C)
- Dimmable TRIAC, 15-100%
- LED Quality DOB
- 10W | 800Lm | 80Lm/W
- CRI 90
- 50,000 hour projected life
- Available in 3000K

Installation

- Quick and easy, one-person ceiling mount installation

Finish

- Available in brushed aluminum, white and black

120V Approved Dimmers

- Lutron : #DVCL-153P, #CTCL-153P, or #DVCL-253P
- Leviton: #6674 or #IPL06

Dimensions (LxWxH)

- 3.66" x 2.52" x 2.68"

Certifications

- ETL/cETL Listed
- 5 year limited warranty

ORDERING

Example: 7584-BA

Model #	Finish	
7584		
7584	BA	Brushed Aluminum
	WW	White
	BK	Black

