

Test Report of Luminaire

Report No.:

Luminaire Type	4424xx-15-3K		
Lamp Type	LED_Wallcylinder		
Client		EUT NO.	CCT: 2986K, CRI: 82.0Ra
Luminaire Parameters:			
Voltage	120.0	Current	0.111
Power:	13.2	Power Factor	0.991
Frequency:	60Hz	Tc	3000K
Photometric Parameters			
Luminaire Flux	843.95 lm	Luminaire Eff.	Data imperfect...!
Max Intensity	1869.716cd	Central Intensity	1869.716cd
Angle of Max Intensity:	C:0 G:0		
Upward Flux Ratio	0.01%		
Downward Flux Ratio	-84395.38%		
50%Imax Beam Width	C0_180[17.0 ,-17.4] C90_270[17.6 ,-18.5]		
Remark			

Luminaire Figure

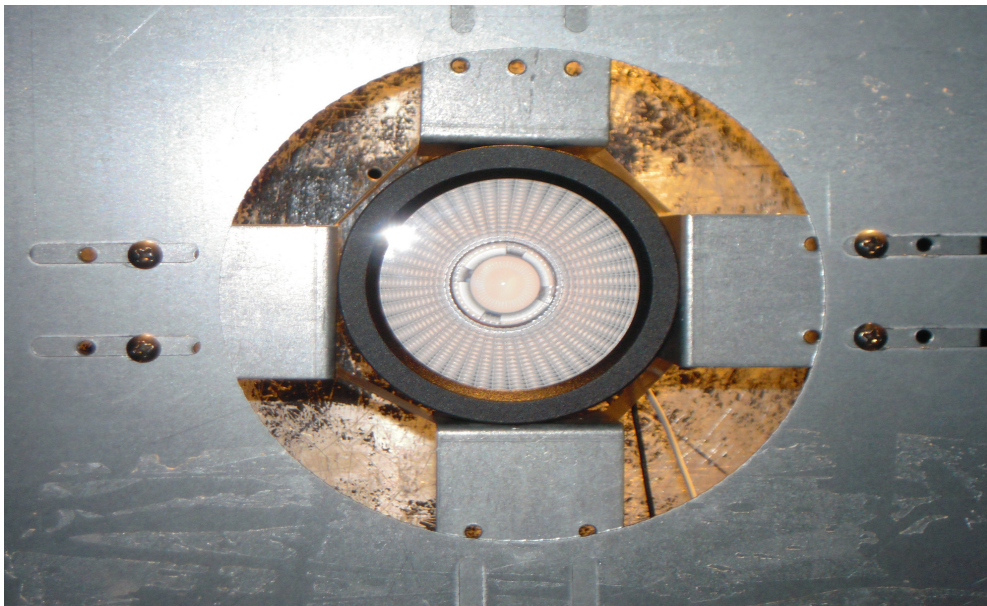

RP Lighting • Fans

Photometric Data Table [Unit:cd] 4424xx-15-3K

C\G	0	5	10	15	20	25	30	35	40	45
0	1869.7	1810.2	1544.8	1110.9	660.9	383.2	239.0	144.1	79.1	41.8
5	1869.7	1810.8	1547.1	1111.5	660.9	384.2	240.0	144.3	79.1	41.6
10	1869.7	1812.8	1550.8	1113.5	665.2	387.2	239.0	144.2	79.2	41.3
15	1869.7	1814.8	1553.1	1120.2	670.6	390.5	239.0	144.9	79.1	40.9
20	1869.7	1816.5	1556.8	1127.6	677.6	394.2	241.0	145.5	79.3	40.6
25	1869.7	1817.8	1559.1	1133.2	681.9	397.5	240.0	145.2	79.6	40.6
30	1869.7	1819.2	1560.8	1134.6	684.6	399.9	241.0	146.4	79.8	40.4
35	1869.7	1820.2	1561.5	1132.9	685.6	400.9	244.7	148.7	80.3	40.5
40	1869.7	1820.8	1560.1	1132.6	685.9	402.9	247.0	152.2	81.0	41.1
45	1869.7	1820.8	1558.5	1132.9	688.6	404.9	248.7	152.4	82.2	42.1
50	1869.7	1818.8	1556.1	1137.6	695.3	409.2	250.3	152.5	83.2	43.2
55	1869.7	1817.5	1553.5	1143.9	704.0	413.2	252.7	154.5	84.4	44.1
60	1869.7	1815.2	1550.5	1152.6	713.0	418.2	255.7	156.8	86.3	45.0
65	1869.7	1813.8	1547.1	1159.9	720.3	421.2	257.0	157.3	86.7	45.5
70	1869.7	1812.2	1543.1	1161.9	724.0	422.6	257.7	158.4	87.2	45.9
75	1869.7	1809.8	1539.8	1160.6	724.3	422.2	259.7	160.4	87.8	46.2
80	1869.7	1807.8	1538.1	1157.6	724.0	422.2	260.4	163.1	88.7	46.5
85	1869.7	1806.5	1537.8	1155.9	724.7	423.9	261.7	162.3	89.8	46.8
90	1869.7	1804.5	1539.5	1158.9	730.0	427.9	262.7	162.5	90.7	47.1
95	1869.7	1803.5	1541.1	1164.6	738.7	431.9	264.0	164.3	91.9	47.2
100	1869.7	1802.8	1544.5	1171.6	748.0	437.6	264.7	164.1	91.5	47.3
105	1869.7	1802.5	1547.1	1177.6	753.4	440.6	265.7	163.8	91.6	46.9
110	1869.7	1802.8	1550.5	1180.0	753.7	440.6	266.4	163.4	91.5	46.5
115	1869.7	1804.2	1553.1	1178.3	748.0	438.6	264.0	161.8	89.9	46.2
120	1869.7	1804.2	1554.5	1172.6	741.4	435.3	264.7	162.0	90.4	46.0
125	1869.7	1803.1	1554.5	1166.9	734.3	432.3	263.0	162.0	90.7	45.8
130	1869.7	1802.8	1552.5	1161.3	731.7	430.3	262.4	161.3	90.8	46.0
135	1869.7	1801.5	1549.5	1156.6	730.0	428.9	260.7	161.1	92.2	47.0
140	1869.7	1799.5	1545.1	1151.9	730.0	428.6	259.4	160.1	91.2	47.1
145	1869.7	1797.8	1540.1	1146.9	728.7	427.9	258.4	159.7	91.0	47.6
150	1869.7	1795.8	1535.8	1140.2	725.3	425.9	257.7	159.4	91.2	48.1
155	1869.7	1794.8	1531.1	1134.9	720.3	422.9	256.0	159.3	91.1	48.3
160	1869.7	1793.1	1526.4	1130.2	715.7	421.2	255.0	159.5	91.8	48.6
165	1869.7	1791.8	1522.8	1126.9	712.6	420.6	254.7	159.5	92.1	48.6
170	1869.7	1788.5	1520.1	1126.2	712.0	421.2	254.7	159.1	91.3	48.7
175	1869.7	1787.1	1518.4	1127.6	714.0	423.9	255.0	159.1	91.6	48.9
180	1869.7	1785.8	1517.8	1129.9	717.7	426.3	256.0	159.4	91.7	48.6
185	1869.7	1784.8	1519.1	1133.9	720.0	428.9	256.0	159.5	91.7	48.6
190	1869.7	1783.1	1521.4	1137.6	721.0	429.3	257.0	159.7	91.9	48.4
195	1869.7	1782.1	1525.4	1140.9	721.0	429.6	257.4	159.7	91.5	48.1
200	1869.7	1781.5	1530.4	1145.9	723.0	429.9	257.7	159.8	91.1	47.4
205	1869.7	1780.5	1534.8	1152.6	727.7	432.9	259.0	160.0	90.1	46.9
210	1869.7	1780.5	1536.4	1159.9	734.3	436.3	260.0	160.8	90.9	46.8
215	1869.7	1780.1	1538.1	1166.6	744.0	441.6	262.4	162.5	92.3	47.6
220	1869.7	1780.8	1540.5	1171.9	752.4	444.9	265.4	164.2	93.8	47.9
225	1869.7	1781.8	1542.5	1176.0	758.4	448.0	267.4	166.7	94.6	48.6
230	1869.7	1783.8	1544.5	1180.3	762.0	451.6	270.7	169.1	97.7	49.6
235	1869.7	1785.1	1547.1	1185.3	766.7	455.6	274.0	171.7	97.7	50.5

RP Lighting • Fans

Photometric Data Table [Unit:cd] 4424xx-15-3K

240	1869.7	1787.8	1549.5	1193.3	776.1	462.3	277.7	175.0	98.7	50.7
245	1869.7	1790.5	1553.8	1203.7	791.4	470.6	282.7	178.3	100.4	51.2
250	1869.7	1793.5	1556.5	1216.7	809.4	480.0	287.4	179.9	100.0	51.6
255	1869.7	1796.5	1561.1	1229.4	825.8	487.3	291.1	180.1	100.6	51.9
260	1869.7	1800.5	1565.5	1236.0	833.1	490.0	292.1	180.8	101.0	51.9
265	1869.7	1803.1	1569.2	1235.0	828.5	487.7	291.1	181.4	99.5	51.1
270	1869.7	1807.2	1573.2	1227.4	813.8	480.3	288.4	180.2	99.7	50.5
275	1869.7	1809.2	1576.8	1215.7	797.1	471.0	284.4	176.0	97.6	49.5
280	1869.7	1811.5	1578.5	1204.3	779.7	460.6	279.7	173.6	95.9	48.2
285	1869.7	1814.2	1580.8	1195.6	767.1	452.6	274.4	172.3	94.0	46.8
290	1869.7	1815.5	1581.8	1190.0	759.7	445.9	268.7	164.6	90.7	45.8
295	1869.7	1816.5	1579.5	1185.3	753.4	440.9	265.4	162.1	88.6	44.8
300	1869.7	1816.8	1578.8	1181.3	746.0	435.3	262.4	160.9	87.1	43.8
305	1869.7	1816.8	1576.2	1173.3	734.3	429.6	261.0	160.0	85.8	43.0
310	1869.7	1815.8	1572.5	1162.9	720.3	421.9	256.4	156.3	84.6	42.6
315	1869.7	1815.5	1568.5	1151.6	707.3	414.2	252.0	155.2	83.6	42.5
320	1869.7	1813.8	1565.2	1144.2	695.6	407.2	249.7	152.2	82.6	42.3
325	1869.7	1811.8	1560.1	1138.9	687.9	400.9	249.3	151.9	81.6	42.1
330	1869.7	1809.8	1555.5	1136.6	683.6	396.2	247.0	149.9	81.0	42.0
335	1869.7	1808.2	1551.8	1137.9	680.3	393.5	242.3	148.0	80.5	41.9
340	1869.7	1805.8	1547.5	1135.9	677.9	390.5	241.3	146.8	80.2	41.8
345	1869.7	1804.2	1544.8	1131.6	673.6	387.5	241.3	145.9	79.8	41.8
350	1869.7	1803.5	1542.1	1123.9	667.6	384.5	238.3	144.6	79.4	41.7
355	1869.7	1803.5	1540.1	1115.5	662.9	382.9	238.3	143.8	79.1	41.7
360	1869.7	1810.2	1544.8	1110.9	660.9	383.2	239.0	144.1	79.1	41.8

C\G	50	55	60	65	70	75	80	85	90
0	15.1	6.4	4.3	3.0	2.2	1.7	1.4	0.7	0.6
5	15.0	6.4	4.3	3.0	2.2	1.8	1.4	0.7	0.6
10	14.9	6.4	4.3	3.0	2.2	1.7	1.4	0.7	0.6
15	14.4	6.5	4.3	3.0	2.2	1.7	1.4	0.7	0.6
20	14.2	6.4	4.3	3.0	2.2	1.7	1.4	0.7	0.6
25	14.5	6.7	4.3	3.0	2.2	1.7	1.4	0.7	0.6
30	14.2	7.0	4.3	3.0	2.2	1.7	1.4	0.7	0.6
35	14.3	7.3	4.3	3.0	2.2	1.7	1.4	0.7	0.6
40	14.7	7.5	4.3	3.0	2.2	1.7	1.3	0.7	0.6
45	15.2	7.7	4.3	3.0	2.2	1.7	1.1	0.7	0.6
50	15.6	7.9	4.3	3.0	2.2	1.7	1.3	0.7	0.6
55	15.9	7.9	4.3	3.0	2.2	1.7	1.4	0.7	0.6
60	16.3	8.1	4.3	3.0	2.2	1.8	1.4	0.8	0.6
65	16.7	8.3	4.3	3.0	2.2	1.8	1.4	0.8	0.6
70	17.0	8.5	4.4	3.1	2.2	1.8	1.4	0.8	0.6
75	17.3	8.6	4.4	3.1	2.2	1.8	1.4	0.8	0.6
80	17.5	8.7	4.4	3.1	2.2	1.8	1.4	0.8	0.6
85	17.7	8.7	4.5	3.1	2.2	1.8	1.5	0.9	0.6
90	18.0	8.8	4.7	3.1	2.3	1.8	1.4	0.8	0.6
95	18.3	8.9	5.0	3.1	2.2	1.8	1.4	0.8	0.6
100	18.3	9.0	5.2	3.2	2.3	1.8	1.4	0.9	0.6

RP Lighting • Fans

Photometric Data Table [Unit:cd] 4424xx-15-3K

105	18.2	8.7	5.2	3.2	2.3	1.8	1.4	0.9	0.6
110	18.1	8.6	5.2	3.2	2.3	1.8	1.5	0.9	0.6
115	18.2	8.6	5.2	3.3	2.3	1.8	1.5	0.9	0.6
120	18.1	8.5	5.2	3.3	2.3	1.8	1.5	0.9	0.6
125	18.1	8.5	5.5	3.3	2.3	1.8	1.4	0.9	0.6
130	18.5	8.8	5.8	3.2	2.3	1.8	1.4	0.9	0.6
135	19.1	9.1	5.8	3.2	2.3	1.7	1.2	0.8	0.6
140	19.6	9.2	6.0	3.3	2.3	1.7	1.2	0.8	0.6
145	20.0	9.2	6.1	3.3	2.3	1.8	1.4	0.9	0.6
150	20.4	9.2	6.2	3.3	2.3	1.8	1.5	0.9	0.6
155	20.6	9.3	6.4	3.3	2.3	1.8	1.4	1.0	0.6
160	20.7	9.3	6.5	3.3	2.3	1.8	1.5	1.0	0.6
165	20.9	9.4	6.6	3.3	2.3	1.8	1.4	0.9	0.6
170	21.0	9.4	6.5	3.3	2.3	1.8	1.4	1.0	0.6
175	21.0	9.3	6.5	3.3	2.3	1.8	1.4	0.9	0.6
180	21.0	9.4	6.5	3.4	2.3	1.8	1.4	0.9	0.6
185	20.9	9.4	6.5	3.4	2.3	1.8	1.4	0.9	0.6
190	20.7	9.3	6.4	3.4	2.4	1.8	1.4	0.9	0.6
195	20.2	9.1	6.2	3.4	2.4	1.8	1.4	0.9	0.6
200	19.7	9.0	6.0	3.4	2.4	1.8	1.4	0.9	0.6
205	19.3	9.0	5.8	3.4	2.4	1.8	1.4	0.9	0.6
210	19.1	8.9	5.8	3.4	2.4	1.8	1.4	0.9	0.6
215	19.1	8.9	5.8	3.4	2.4	1.8	1.4	0.9	0.6
220	19.3	9.1	6.2	3.3	2.3	1.8	1.3	0.9	0.6
225	19.6	9.3	6.4	3.4	2.3	1.7	1.2	0.8	0.6
230	19.6	9.3	6.4	3.3	2.3	1.8	1.3	0.9	0.6
235	19.7	9.2	6.5	3.3	2.3	1.8	1.4	0.9	0.6
240	19.7	9.2	6.6	3.3	2.3	1.8	1.4	0.9	0.6
245	19.7	9.2	6.6	3.3	2.3	1.8	1.4	0.9	0.6
250	19.5	9.1	6.6	3.2	2.3	1.8	1.4	0.9	0.6
255	19.4	9.1	6.5	3.2	2.3	1.8	1.4	0.9	0.6
260	19.1	9.0	6.4	3.2	2.2	1.8	1.4	0.8	0.6
265	18.7	8.8	6.2	3.2	2.3	1.8	1.4	0.8	0.6
270	18.4	8.8	6.1	3.2	2.3	1.8	1.4	0.8	0.6
275	17.9	8.7	5.8	3.2	2.3	1.8	1.4	0.8	0.6
280	17.3	8.6	5.4	3.2	2.3	1.8	1.4	0.8	0.6
285	16.6	8.3	5.0	3.2	2.3	1.8	1.4	0.8	0.6
290	16.3	8.0	4.8	3.2	2.3	1.8	1.4	0.8	0.6
295	16.1	7.6	4.7	3.2	2.3	1.8	1.4	0.7	0.6
300	15.8	7.2	4.5	3.1	2.2	1.8	1.4	0.8	0.6
305	15.5	6.9	4.4	3.1	2.2	1.7	1.3	0.7	0.6
310	15.4	6.9	4.4	3.1	2.2	1.7	1.2	0.7	0.6
315	15.4	7.0	4.4	3.0	2.2	1.7	1.1	0.7	0.6
320	15.2	6.9	4.3	3.0	2.2	1.7	1.2	0.7	0.6
325	15.0	6.8	4.3	3.0	2.2	1.7	1.4	0.7	0.6
330	15.0	6.6	4.3	3.0	2.2	1.7	1.4	0.7	0.6
335	15.0	6.5	4.3	3.0	2.1	1.7	1.4	0.7	0.6
340	15.0	6.5	4.3	3.0	2.2	1.7	1.4	0.7	0.6
345	15.1	6.5	4.3	3.0	2.2	1.7	1.3	0.7	0.6

RP Lighting • Fans

Photometric Data Table [Unit:cd] 4424xx-15-3K

350	15.2	6.5	4.3	3.0	2.2	1.8	1.3	0.7	0.6
355	15.2	6.4	4.3	3.0	2.1	1.7	1.4	0.7	0.6
360	15.1	6.4	4.3	3.0	2.2	1.7	1.4	0.7	0.6

RP Lighting • Fans Zonal

Flux 4424xx-15-3K

Gamma [°]	I_{mean} [cd]	Zonal Flux [lm]	Sum.Flux [lm]	Zonal Flux [%]	Sum.Flux [%]
0	1869.72	0.00	0.00	0.00	0.00
5	1802.88	43.90	43.90	-4390.48	-4390.48
10	1549.62	119.93	163.83	-11992.94	-16383.42
15	1158.33	160.63	324.47	-16063.39	-32446.79
20	727.50	155.42	479.89	-15541.91	-47988.71
25	427.27	121.11	601.00	-12111.41	-60100.11
30	259.29	86.88	687.89	-8688.48	-68788.61
35	159.83	61.72	749.61	-6171.92	-74960.55
40	88.92	41.50	791.11	-4150.31	-79110.88
45	45.92	24.97	816.08	-2496.66	-81607.53
50	17.59	12.83	828.91	-1283.29	-82890.81
55	8.23	5.61	834.52	-561.37	-83452.17
60	5.26	3.12	837.64	-311.76	-83763.89
65	3.17	2.05	839.69	-205.04	-83968.91
70	2.26	1.38	841.07	-137.65	-84106.52
75	1.77	1.06	842.12	-105.55	-84211.97
80	1.38	0.84	842.96	-84.49	-84296.43
85	0.82	0.60	843.56	-59.80	-84356.21
90	0.61	0.39	843.95	-39.07	-84395.30

RP Lighting • Fans

Coefficient Utilization Curve 4424xx-15-3K

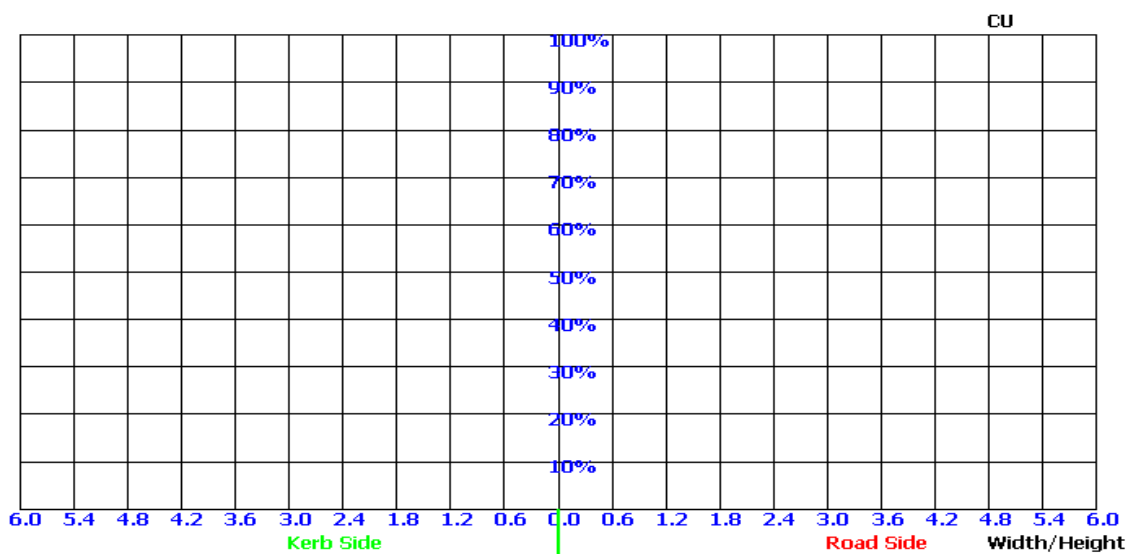

Light Distribution Curve[Unit: cd]

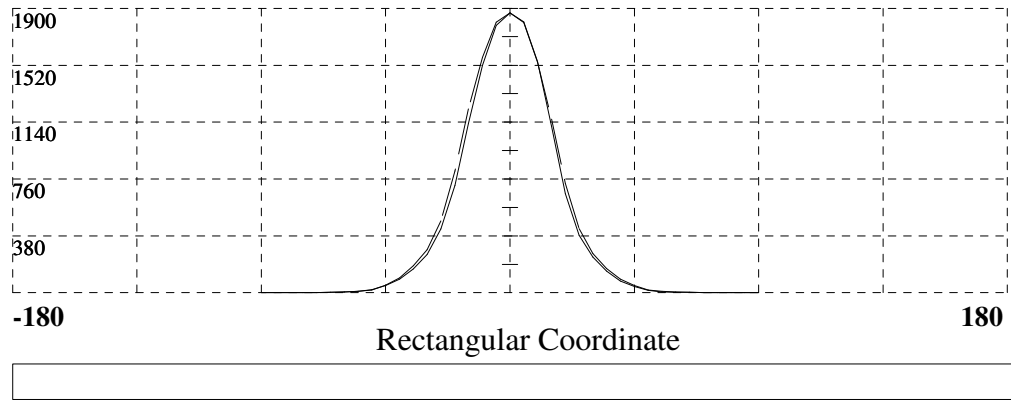
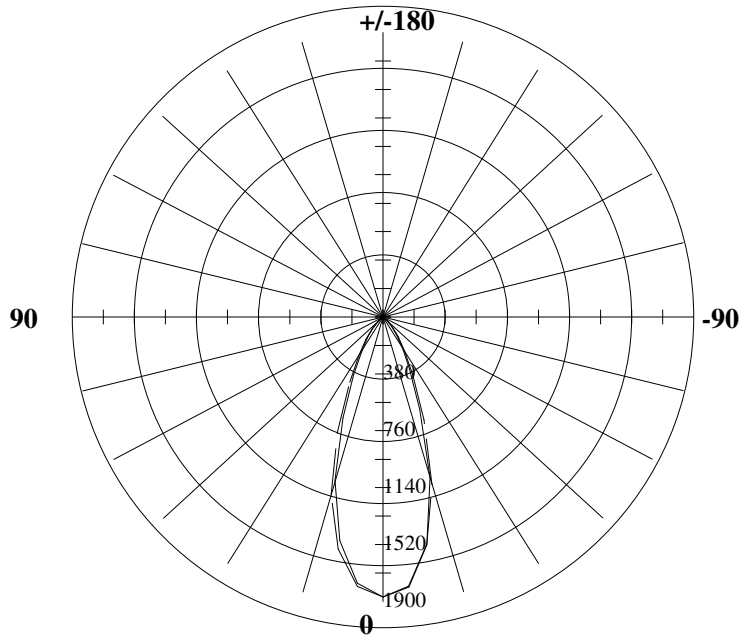

RP Lighting • Fans

ISO-Candela V-H [Unit :cd] 4424xx-15-3K

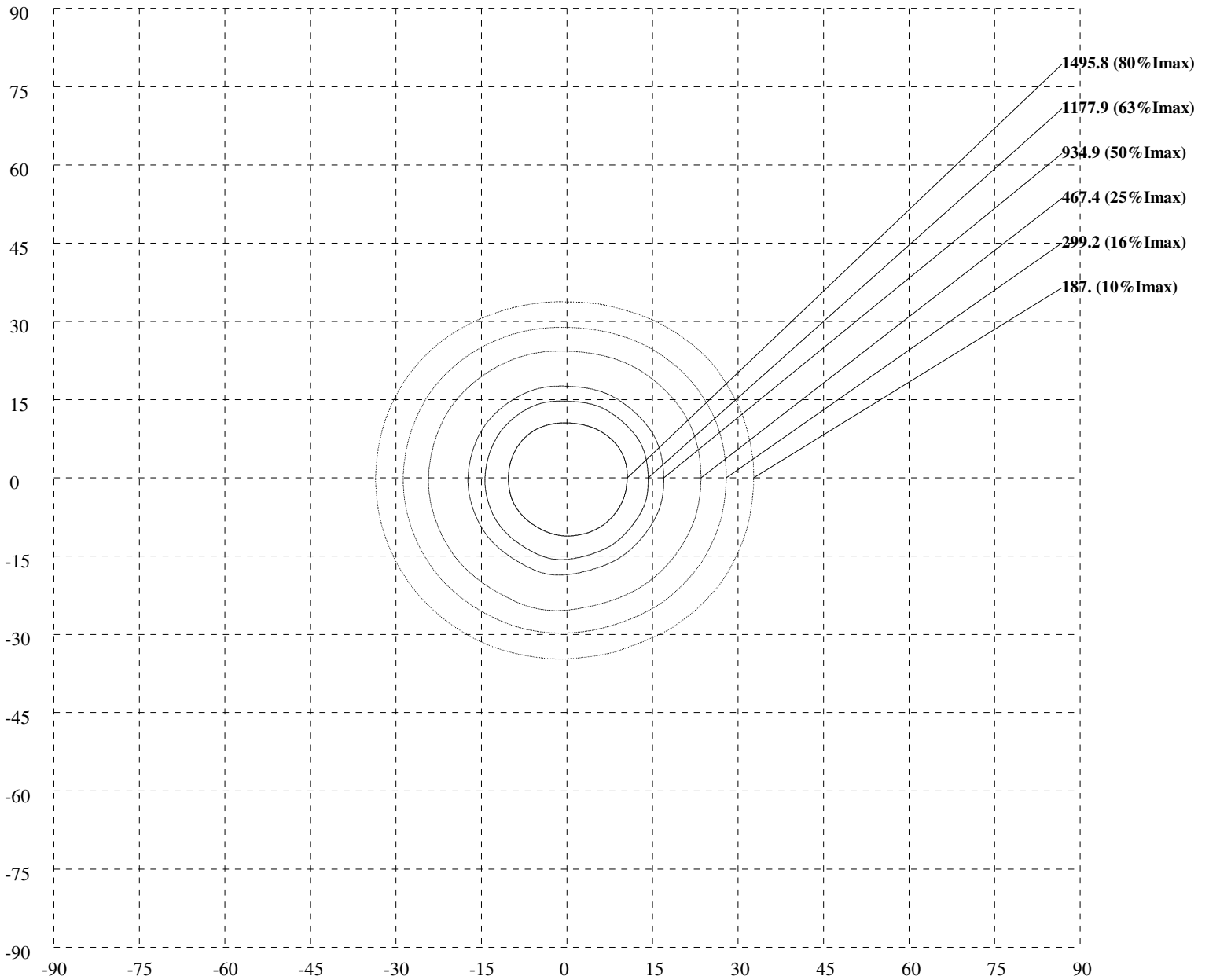

RP Lighting • Fans

Iso-Lux [Unit :lx] 4424xx-15-3K

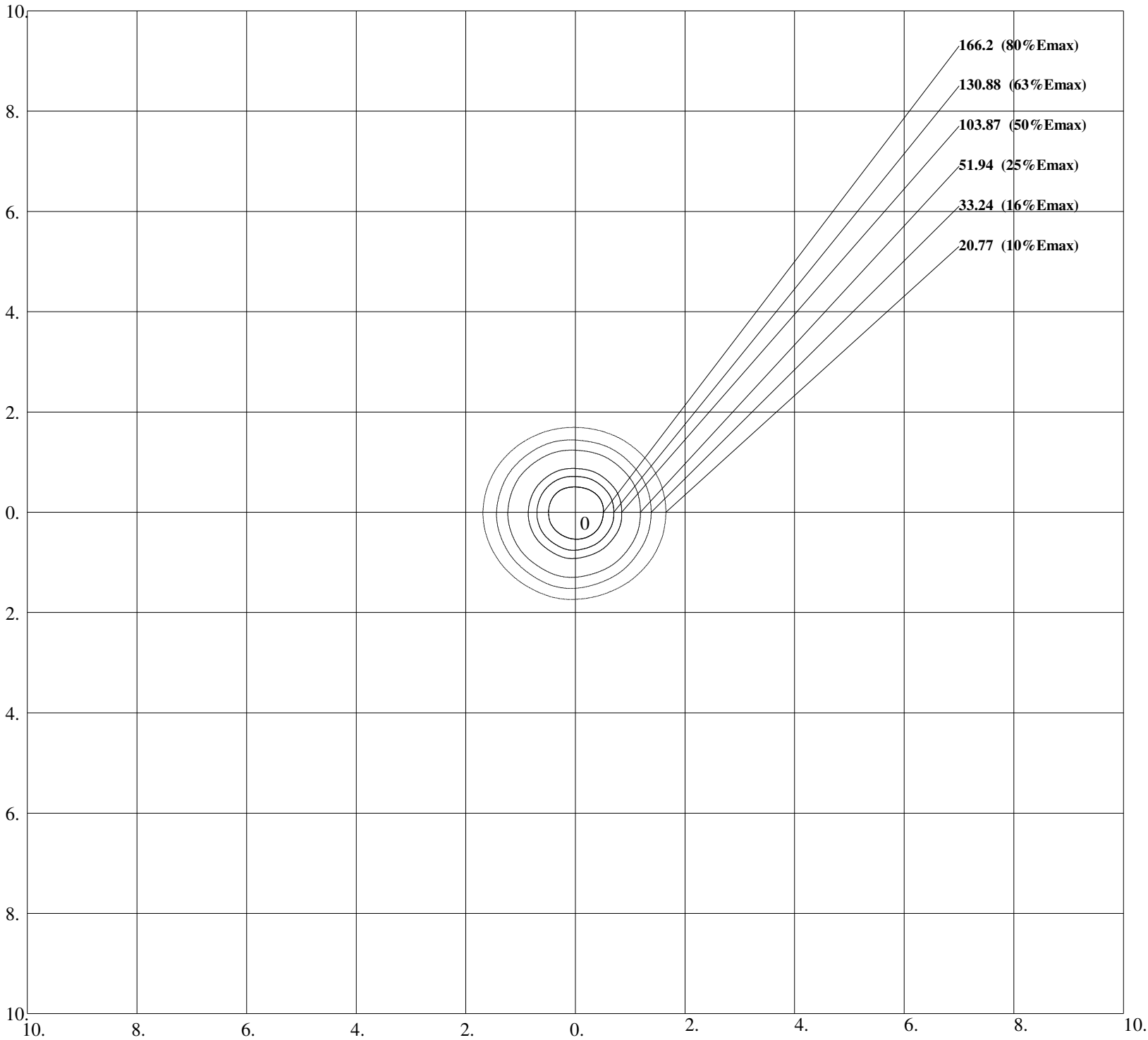

Units: lx
Height: 3 m
Max Illuminance : 207.75lx

RP Lighting • Fans

Lux-Distance Curve

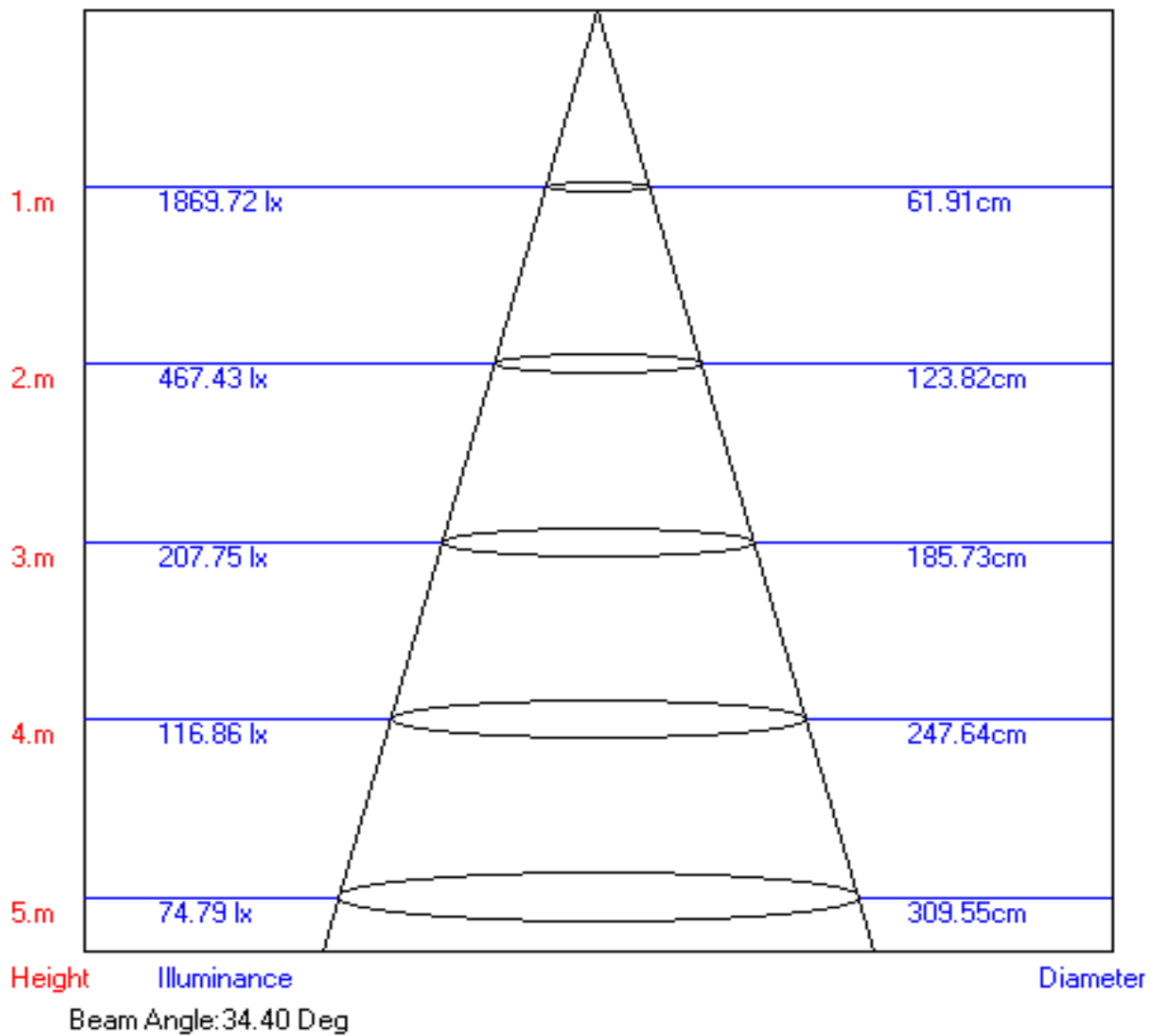

Test Report of Luminaire

Report No.:

Luminaire Type	4424xx-20-3K		
Lamp Type	LED_Wallcylinder		
Client		EUT NO.	CCT: 2938K, CRI: 80.9Ra
Luminaire Parameters:			
Voltage	120.0	Current	0.137
Power:	16.3	Power Factor	0.986
Frequency:	60Hz	Tc	3000K
Photometric Parameters			
Luminaire Flux	1029.03 lm	Luminaire Eff.	Data imperfect...!
Max Intensity	2253.167cd	Central Intensity	2253.167cd
Angle of Max Intensity:	C:0 G:0		
Upward Flux Ratio	0.0%		
Downward Flux Ratio	-102903.4%		
50%Imax Beam Width	C0_180[18.4 , -17.2] C90_270[17.1 , -17.8]		
Remark			

Luminaire Figure

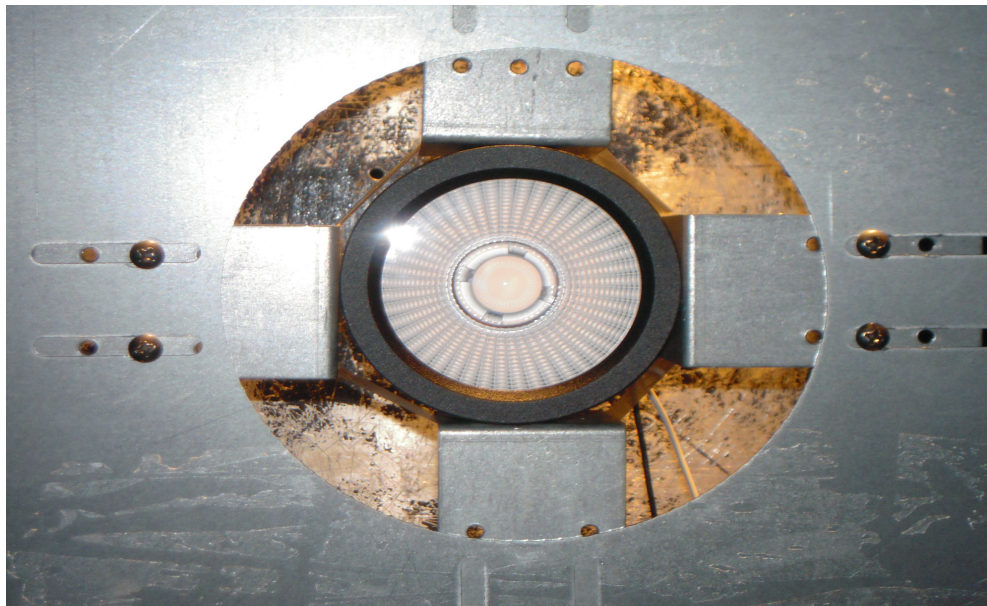

RP Lighting • Fans

Photometric Data Table [Unit:cd] 4424xx-20-3K

C\G	0	5	10	15	20	25	30	35	40	45
0	2253.2	2199.4	1929.3	1483.4	951.3	559.1	339.1	222.6	122.1	61.9
5	2253.2	2195.7	1922.6	1474.4	945.6	556.4	336.8	218.3	120.3	61.6
10	2253.2	2191.7	1913.6	1463.0	936.3	551.4	333.5	214.3	118.1	60.9
15	2253.2	2187.3	1904.0	1450.0	925.3	545.8	333.1	215.0	117.0	60.2
20	2253.2	2183.0	1893.9	1435.6	912.6	538.7	328.8	213.0	116.1	59.9
25	2253.2	2178.0	1884.9	1421.0	899.6	532.4	324.8	211.3	115.5	60.1
30	2253.2	2171.7	1876.2	1408.6	887.6	526.1	321.4	209.6	115.2	60.5
35	2253.2	2166.6	1866.9	1396.9	877.9	519.7	317.4	206.0	114.0	60.5
40	2253.2	2161.6	1859.6	1386.6	869.2	515.4	315.8	204.9	113.5	60.6
45	2253.2	2157.3	1853.2	1379.6	863.2	510.7	312.8	203.6	113.0	60.6
50	2253.2	2152.0	1846.2	1371.6	857.5	508.0	311.8	202.3	112.8	60.5
55	2253.2	2146.6	1840.2	1365.5	852.8	504.4	312.4	202.6	112.8	60.6
60	2253.2	2142.3	1834.2	1358.5	850.2	502.7	311.8	201.3	112.8	60.7
65	2253.2	2138.3	1827.2	1352.2	846.8	501.4	312.4	201.9	112.9	60.8
70	2253.2	2135.3	1820.8	1346.9	845.8	502.4	312.1	202.3	113.0	60.8
75	2253.2	2131.9	1815.8	1340.8	844.5	503.4	311.1	201.9	113.1	60.8
80	2253.2	2130.3	1810.8	1337.2	845.2	505.7	312.8	202.9	113.4	60.6
85	2253.2	2128.9	1806.5	1333.8	846.2	508.4	314.4	203.6	113.4	60.0
90	2253.2	2125.6	1803.8	1331.8	847.5	510.0	314.4	203.3	113.1	59.7
95	2253.2	2125.3	1801.8	1330.5	848.8	512.4	314.1	202.3	113.0	59.5
100	2253.2	2125.3	1800.1	1332.2	851.2	513.4	313.4	202.3	112.9	59.3
105	2253.2	2125.3	1797.8	1332.5	853.8	516.0	316.1	203.9	113.8	59.0
110	2253.2	2123.3	1796.8	1334.2	855.2	517.0	318.1	207.0	114.8	59.1
115	2253.2	2123.6	1796.1	1335.8	855.2	518.0	319.1	206.6	115.1	59.6
120	2253.2	2123.3	1795.8	1335.8	855.8	517.7	319.1	207.0	115.0	60.0
125	2253.2	2122.9	1795.5	1335.8	857.2	518.7	319.1	207.3	115.4	60.2
130	2253.2	2122.6	1795.1	1335.5	858.2	518.4	319.1	207.6	115.5	60.5
135	2253.2	2122.3	1794.5	1335.5	860.5	519.4	319.8	208.6	116.3	60.7
140	2253.2	2121.9	1794.5	1335.2	860.9	518.7	319.8	209.3	115.9	60.5
145	2253.2	2121.6	1794.1	1334.2	860.5	517.0	319.8	209.0	115.4	60.3
150	2253.2	2122.9	1794.1	1335.8	859.5	516.4	318.8	208.6	115.3	60.1
155	2253.2	2123.9	1795.8	1337.5	856.2	515.0	318.4	207.3	115.0	59.5
160	2253.2	2124.9	1797.5	1338.5	855.2	515.7	318.1	208.0	114.6	59.1
165	2253.2	2126.6	1800.5	1339.2	854.2	516.0	316.8	207.3	114.4	58.3
170	2253.2	2128.9	1803.5	1341.2	852.2	516.4	316.1	205.6	112.8	57.5
175	2253.2	2129.9	1807.5	1343.2	850.5	516.0	314.1	204.6	113.2	56.5
180	2253.2	2131.3	1810.2	1345.9	849.2	515.4	313.4	202.6	110.4	55.3
185	2253.2	2133.3	1812.8	1348.2	847.5	513.7	312.4	199.9	109.1	54.4
190	2253.2	2134.3	1816.2	1349.2	847.2	511.7	310.8	199.6	107.6	53.8
195	2253.2	2136.6	1818.8	1350.2	845.5	511.4	311.4	199.6	107.7	53.1
200	2253.2	2138.6	1821.5	1350.5	842.8	508.7	310.4	200.9	109.0	52.9
205	2253.2	2140.9	1823.5	1351.9	840.2	508.0	310.1	199.9	109.3	53.0
210	2253.2	2144.0	1826.2	1352.5	836.8	506.0	309.1	198.6	107.8	53.1
215	2253.2	2145.6	1830.2	1354.5	837.2	505.0	307.1	198.9	108.7	53.3
220	2253.2	2149.6	1834.9	1356.2	837.5	503.7	307.4	198.9	107.5	53.5
225	2253.2	2152.3	1840.5	1358.5	838.2	502.4	306.8	198.6	107.8	53.8
230	2253.2	2156.0	1844.9	1360.9	838.8	501.0	307.1	198.6	108.7	54.1
235	2253.2	2159.6	1850.2	1366.5	841.2	500.0	307.8	198.3	107.8	54.1

RP Lighting • Fans

Photometric Data Table [Unit:cd] 4424xx-20-3K

240	2253.2	2160.0	1857.9	1373.2	844.2	500.4	307.4	199.6	108.4	54.8
245	2253.2	2167.7	1865.2	1381.6	848.8	501.4	308.4	199.9	108.6	54.7
250	2253.2	2172.0	1874.9	1390.2	855.2	505.4	310.4	200.3	108.7	55.0
255	2253.2	2175.3	1883.9	1399.6	861.2	509.0	311.1	201.6	110.4	55.4
260	2253.2	2180.7	1890.9	1409.6	865.5	513.4	313.8	202.9	110.4	55.4
265	2253.2	2183.7	1898.9	1420.6	871.2	518.4	315.4	204.3	110.7	55.6
270	2253.2	2187.0	1906.6	1431.0	878.5	522.4	317.4	206.3	112.1	55.5
275	2253.2	2190.0	1914.6	1442.3	886.9	527.4	320.1	206.3	111.5	55.4
280	2253.2	2192.0	1921.0	1451.0	896.2	530.4	320.8	206.3	110.7	55.6
285	2253.2	2194.7	1925.7	1458.7	904.2	536.7	325.1	209.3	112.7	56.1
290	2253.2	2196.0	1929.0	1467.7	910.3	541.4	328.1	213.0	116.2	57.6
295	2253.2	2196.0	1930.7	1473.7	916.9	545.1	330.8	214.6	116.6	58.3
300	2253.2	2197.4	1933.0	1479.7	925.3	549.1	333.8	215.6	117.8	58.4
305	2253.2	2197.4	1934.3	1485.0	933.0	551.1	335.1	217.0	118.9	59.5
310	2253.2	2198.7	1936.3	1489.7	940.6	553.4	336.8	218.6	120.3	60.5
315	2253.2	2199.0	1937.3	1493.7	943.3	554.8	338.5	221.0	121.7	61.3
320	2253.2	2200.7	1939.0	1495.7	946.6	556.4	339.8	223.3	122.7	62.0
325	2253.2	2201.7	1939.3	1497.1	952.3	557.4	341.8	223.6	123.6	62.8
330	2253.2	2202.0	1942.0	1499.1	957.0	559.4	342.8	224.0	123.7	62.9
335	2253.2	2201.4	1943.0	1501.1	962.7	561.1	343.8	225.0	124.9	63.5
340	2253.2	2201.0	1941.0	1501.1	964.0	562.1	343.5	225.3	124.4	63.3
345	2253.2	2200.7	1938.3	1498.7	963.3	563.1	343.5	226.3	124.5	63.3
350	2253.2	2199.4	1935.3	1495.7	960.3	562.4	342.1	225.6	124.4	63.0
355	2253.2	2197.4	1930.7	1489.4	956.0	561.4	340.5	224.3	123.6	62.3
360	2253.2	2199.4	1929.3	1483.4	951.3	559.1	339.1	222.6	122.1	61.9

C\G	50	55	60	65	70	75	80	85	90
0	23.6	10.5	6.4	3.8	2.7	2.0	1.6	0.9	0.6
5	23.8	10.4	6.2	3.9	2.7	2.0	1.6	0.9	0.6
10	23.7	10.1	5.9	3.9	2.7	2.0	1.6	0.9	0.6
15	23.5	9.7	5.6	3.8	2.7	2.0	1.6	1.0	0.6
20	23.4	10.2	5.6	3.8	2.7	2.0	1.6	1.0	0.6
25	23.8	10.2	5.5	3.8	2.6	2.0	1.6	1.0	0.6
30	24.2	10.5	5.5	3.8	2.6	2.0	1.6	1.0	0.6
35	24.2	10.6	5.5	3.7	2.6	2.0	1.6	1.0	0.6
40	24.4	10.5	5.5	3.8	2.6	1.8	1.5	0.9	0.6
45	24.5	10.2	5.5	3.8	2.6	1.7	1.3	0.8	0.6
50	24.6	9.8	5.5	3.8	2.6	1.8	1.4	0.9	0.6
55	24.7	9.5	5.5	3.8	2.7	1.9	1.6	1.0	0.6
60	24.7	9.1	5.5	3.7	2.6	2.0	1.7	1.0	0.7
65	24.7	8.8	5.5	3.8	2.7	2.1	1.7	1.0	0.6
70	24.8	8.8	5.5	3.8	2.7	2.1	1.6	1.0	0.6
75	24.8	8.9	5.5	3.8	2.7	2.1	1.7	1.0	0.6
80	24.5	9.2	5.5	3.8	2.7	2.1	1.6	1.0	0.6
85	24.0	9.6	5.5	3.8	2.7	2.1	1.7	1.0	0.6
90	23.4	9.7	5.5	3.8	2.7	2.1	1.7	1.0	0.6
95	23.2	9.6	5.5	3.8	2.7	2.1	1.6	1.0	0.6
100	23.1	9.9	5.6	3.8	2.7	2.1	1.7	1.0	0.6

RP Lighting • Fans

Photometric Data Table [Unit:cd] 4424xx-20-3K

105	22.5	10.2	5.6	3.8	2.7	2.1	1.7	1.0	0.6
110	22.7	10.7	5.5	3.8	2.7	2.1	1.7	1.0	0.6
115	22.9	11.0	5.5	3.8	2.7	2.1	1.7	1.0	0.6
120	23.3	11.1	5.5	3.8	2.7	2.1	1.7	1.0	0.6
125	23.3	11.0	5.4	3.7	2.7	2.1	1.7	1.0	0.7
130	23.0	11.0	5.4	3.7	2.7	1.9	1.6	0.9	0.6
135	23.0	10.9	5.4	3.8	2.7	1.8	1.4	0.7	0.6
140	22.8	11.0	5.4	3.7	2.7	1.9	1.4	0.8	0.6
145	22.6	11.0	5.4	3.7	2.7	1.9	1.6	0.9	0.6
150	22.3	10.9	5.4	3.7	2.7	2.1	1.7	0.9	0.6
155	21.9	10.8	5.4	3.7	2.6	2.1	1.7	0.9	0.6
160	21.6	10.8	5.7	3.7	2.6	2.1	1.7	0.9	0.6
165	21.4	10.8	6.0	3.7	2.6	2.1	1.7	0.9	0.6
170	21.0	10.9	6.1	3.7	2.7	2.1	1.6	0.9	0.6
175	20.3	10.6	6.1	3.7	2.7	2.1	1.7	0.9	0.6
180	19.6	10.2	6.1	3.7	2.7	2.1	1.6	0.9	0.6
185	19.4	10.0	5.9	3.8	2.7	2.1	1.6	0.9	0.6
190	19.2	10.0	6.0	3.8	2.7	2.1	1.6	0.9	0.7
195	19.0	9.9	6.0	3.7	2.6	2.1	1.6	0.9	0.6
200	18.8	10.0	6.3	3.7	2.6	2.0	1.6	0.8	0.6
205	19.0	10.3	6.2	3.7	2.6	2.1	1.6	0.8	0.6
210	19.2	10.4	6.2	3.7	2.6	2.0	1.6	0.8	0.6
215	19.2	10.4	6.4	3.7	2.6	2.0	1.5	0.8	0.6
220	19.2	10.3	6.4	3.6	2.6	1.9	1.4	0.8	0.6
225	19.2	10.3	6.6	3.6	2.6	1.9	1.3	0.7	0.6
230	19.2	10.3	6.8	3.6	2.6	1.9	1.4	0.7	0.6
235	19.3	10.2	7.0	3.6	2.6	1.9	1.5	0.8	0.6
240	19.4	10.3	7.1	3.7	2.5	2.0	1.5	0.8	0.6
245	19.5	10.3	7.1	3.7	2.6	2.0	1.5	0.8	0.6
250	19.7	10.4	7.1	3.7	2.5	2.0	1.5	0.8	0.6
255	19.6	10.4	7.2	3.7	2.6	2.0	1.5	0.8	0.6
260	19.9	10.4	7.2	3.7	2.6	2.0	1.5	0.8	0.6
265	19.7	10.4	7.1	3.7	2.6	2.0	1.5	0.8	0.6
270	19.4	10.1	6.8	3.7	2.6	2.0	1.5	0.8	0.6
275	19.6	10.1	6.5	3.8	2.6	2.0	1.5	0.8	0.6
280	19.7	10.2	6.4	3.8	2.6	2.0	1.5	0.8	0.6
285	19.9	10.2	6.5	3.8	2.6	2.0	1.5	0.8	0.6
290	20.1	10.2	6.7	3.8	2.6	2.0	1.5	0.8	0.6
295	20.6	10.6	7.2	3.8	2.6	2.0	1.5	0.8	0.6
300	21.3	10.9	7.3	3.7	2.6	2.0	1.5	0.8	0.6
305	21.5	10.9	7.4	3.7	2.6	1.9	1.5	0.8	0.6
310	21.9	10.9	7.5	3.7	2.6	1.9	1.4	0.7	0.6
315	22.3	11.0	7.5	3.7	2.6	1.8	1.3	0.7	0.6
320	22.7	11.1	7.5	3.7	2.6	1.9	1.4	0.8	0.6
325	23.0	11.1	7.5	3.7	2.6	2.0	1.5	0.9	0.6
330	23.3	11.1	7.5	3.7	2.6	2.0	1.5	0.9	0.6
335	23.6	11.1	7.4	3.7	2.6	2.0	1.5	0.9	0.6
340	23.8	11.1	7.4	3.8	2.6	2.0	1.6	0.9	0.6
345	24.0	11.1	7.3	3.7	2.6	2.0	1.6	0.9	0.6

RP Lighting • Fans

Photometric Data Table [Unit:cd] 4424xx-20-3K

350	24.1	11.1	7.1	3.8	2.6	2.0	1.6	0.9	0.6
355	23.8	10.8	6.9	3.8	2.6	2.0	1.6	0.9	0.6
360	23.6	10.5	6.4	3.8	2.7	2.0	1.6	0.9	0.6

RP Lighting • Fans

Zonal Flux 4424xx-20-3K

Gamma [°]	I_{mean} [cd]	Zonal Flux [lm]	Sum.Flux [lm]	Zonal Flux [%]	Sum.Flux [%]
0	2253.17	0.00	0.00	0.00	0.00
5	2159.05	52.75	52.75	-5274.69	-5274.69
10	1859.03	143.74	196.49	-14373.93	-19648.62
15	1394.73	193.01	389.50	-19301.05	-38949.66
20	879.10	187.40	576.89	-18739.55	-57689.20
25	523.81	147.14	724.03	-14714.02	-72403.21
30	320.57	106.86	830.89	-10685.76	-83088.99
35	208.08	77.85	908.74	-7784.73	-90873.71
40	114.44	53.81	962.55	-5380.91	-96254.63
45	58.58	32.04	994.58	-3203.54	-99458.15
50	21.99	16.28	1010.86	-1628.02	-101086.17
55	10.38	7.04	1017.90	-703.85	-101790.00
60	6.24	3.84	1021.74	-384.27	-102174.26
65	3.75	2.43	1024.17	-242.88	-102417.14
70	2.64	1.62	1025.79	-161.77	-102579.00
75	2.00	1.21	1027.00	-121.36	-102700.34
80	1.56	0.95	1027.96	-95.33	-102795.75
85	0.88	0.66	1028.62	-66.39	-102862.08
90	0.63	0.41	1029.04	-41.46	-102903.53

RP Lighting • Fans

Coefficient Utilization Curve 4424xx-20-3K

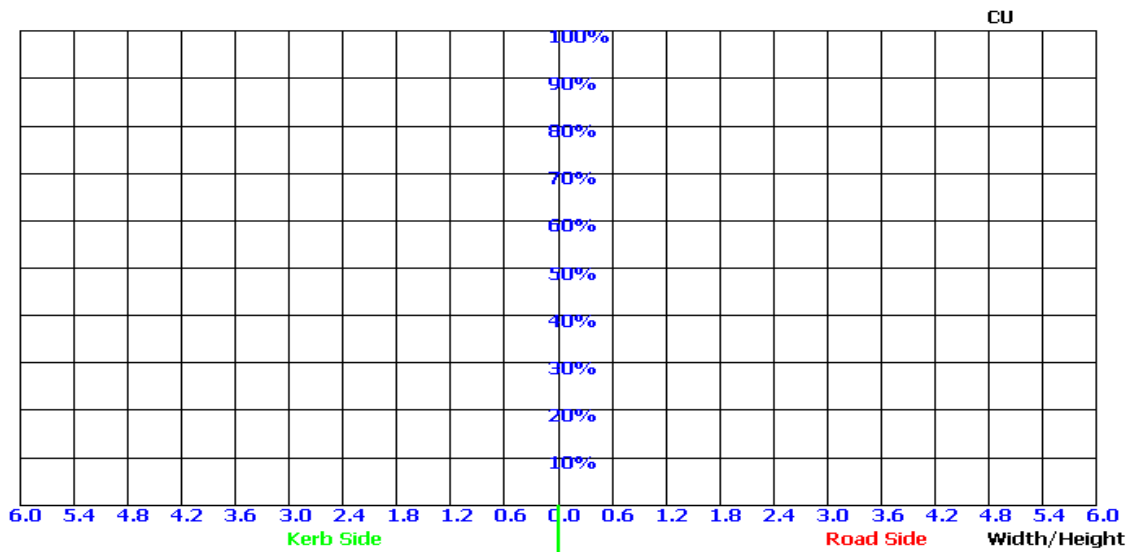

Light Distribution Curve[Unit: cd]

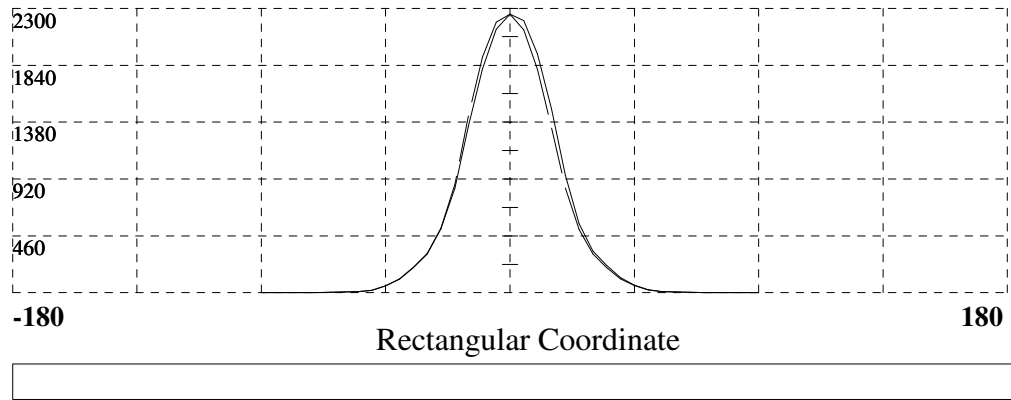
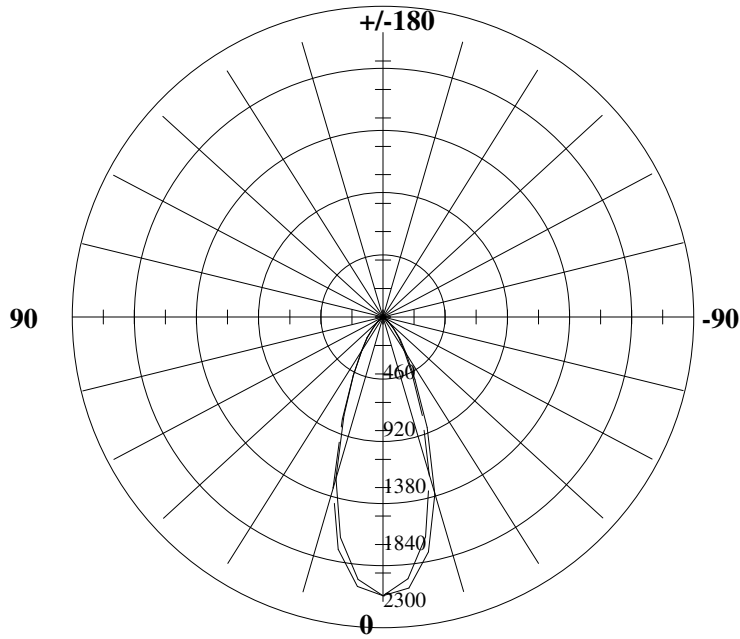

RP Lighting • Fans

ISO-Candela V-H [Unit :cd] 4424xx-20-3K

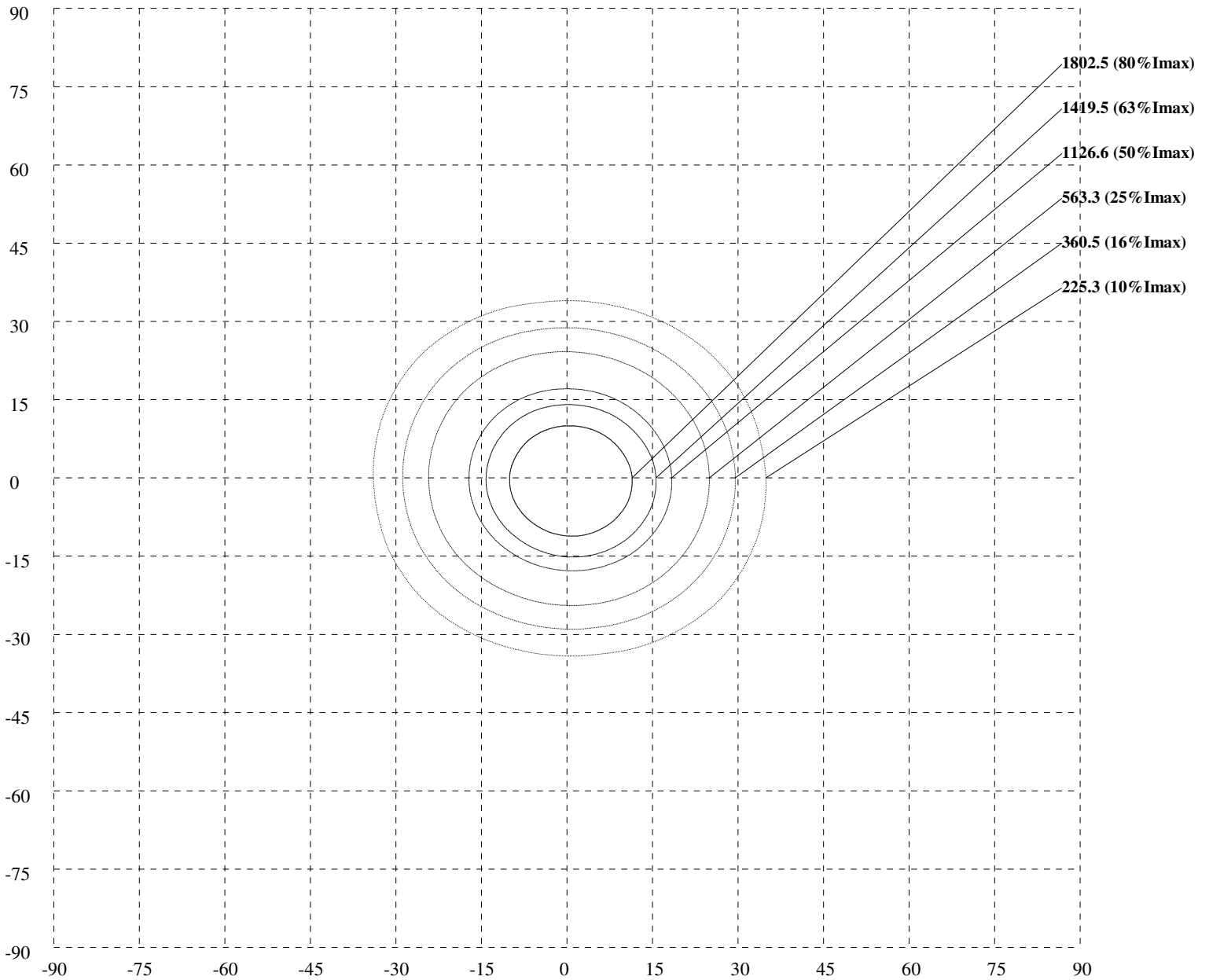

RP Lighting • Fans

Iso-Lux [Unit :lx] 4424xx-20-3K

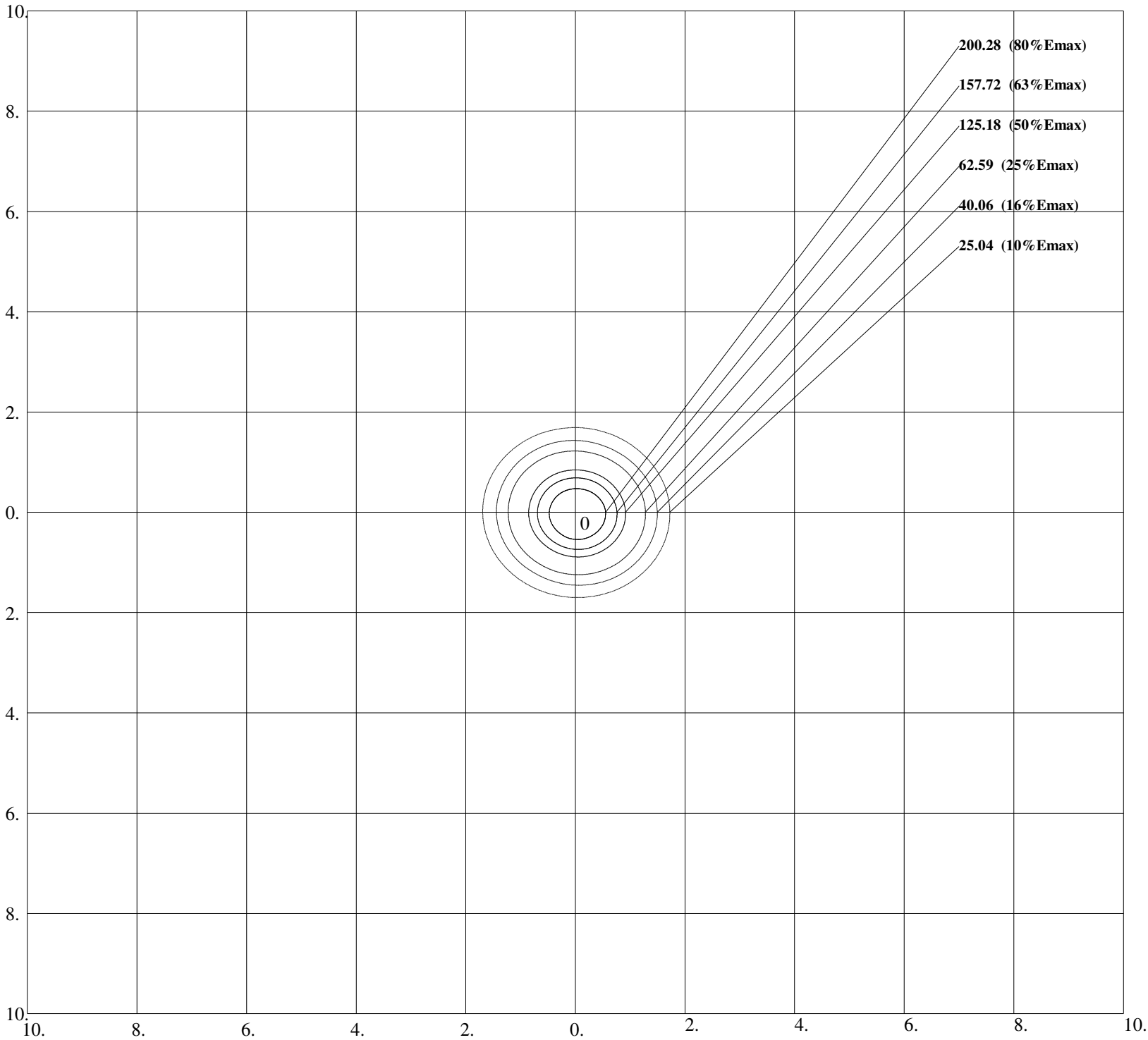

Units: lx
Height: 3 m
Max Illuminance : 250.35lx

RP Lighting • Fans

Lux-Distance Curve

