



HEAT. ANYTIME. ANYWHERE.

When comfort is paramount and space is at a premium.



**WE ARE
HERE** *to help!*

**Marley
Support
Services**

TECHNICAL SERVICES

Phone: 800-642-4328

Hours of Operation: Monday-Friday, 8am-4:30pm EST

Email: webmaster@marleymep.com

Marley products are available through authorized electrical, heating and cooling distributors and manufacturers' representatives.

For international sales and other inquiries, please contact us via the Headquarters contact information.

NOTICES DEPARTMENT

All insurance, notice of inspection, certified or other legal correspondence should be sent to the appropriate options below:

Email: mep.notices@marleymep.com

Fax: 843-432-3199

Marley Engineered Products: Notice Department
470 Beauty Spot Road East
Bennettsville, South Carolina 29512

HEADQUARTERS

Marley Engineered Products
470 Beauty Spot Road East
Bennettsville, South Carolina 29512

Phone: 843-479-4006

Email: webmaster@marleymep.com

THE MARLEY

Difference

INNOVATION & TECHNOLOGY



Custom design capabilities across product portfolio

First to market with SmartSeries™ controls

Robust control offering featuring connected products

COMPREHENSIVE SUPPORT & SERVICE



In-house customer service, tech services & engineering teams

Manufacturing based in South Carolina, USA

Coast to coast network of sales representatives

Largest distribution network in the industry

CUSTOM SOLUTIONS TEAM



50+ years of custom heating & ventilation design experience

Full tech services & engineering team in house

Supporting you from design to installation & after-sales service

500,000+ sq. ft. manufacturing facility in Bennettsville, SC.

Our American workers build the solutions you can rely on for years to come

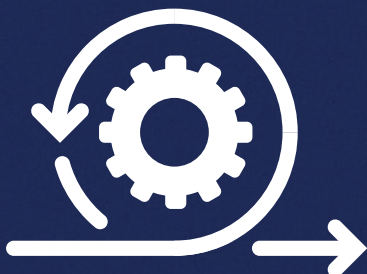

360° PROJECT SUPPORT

60+ representative agencies throughout North America

Over 50 years of engineering and technical expertise in heating

Products are designed, engineered & assembled in **Bennettsville, SC**

MARLEY COMFORT



Transportation



Healthcare



Industrial



Education



Office / Multi-use



Religious



Assisted Living



Residential



Multifamily



Restaurants



Retail



Parking Garage



Hazardous Environment

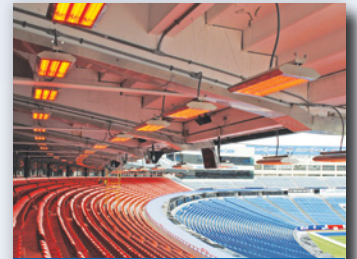

Entertainment



Hospitality

for every industry

Comfort Solutions **FOR ALL YOUR SPACES**

FOR FREEZE PROTECTION

Install anywhere heat is needed

Prevent pipes, pumps and other water or fluid-filled equipment from freezing.

Automatic, 24-hour protection

Just set the thermostat and leave it.

Corrosion Protection

Galvanized steel housing and epoxy paint for maximum durability.



WHT500 Series | Utility Well/Pump House Heater

FOR SMALL SPACES

Stay cozy in close quarters

Compact-sized wall heater is ideal for residential or commercial installations.

Efficient and quiet

Smooth-running, multi-layer impeller so you will feel the warmth not hear it.

Fast and easy installation

CLIP-N-FIT® feature easily adjusts to half wattage for ultimate flexibility



COS-E Series | Fan-Forced Wall Heater

FOR PERSONAL SPACES

Deliver personalized warmth

Ideal for offices, workstations, conference rooms or reception areas.

Heat your target, not the air

Radiant heaters deliver focused warmth, just like the sun.

Save on energy costs

Energy-efficient; operates on less than a dollar a week*.



202SL Series | Radiant Plug-In Under Desk Heater

*Cost estimate based on energy cost of 10 cents per kWh in 5-day work week.

FOR RESIDENTIAL SPACES

Stable, gentle heat

Hydronic design with large heat reservoir maintains consistent temperatures for sustained comfort, reducing thermostat cycling.

Fewer allergens in the air

Natural convection airflow — no fans or blowers to circulate dust or allergens.

Easy to install

Low profile and UL-listed for flush wall and floor mounting.



HBB Series | Electric Hydronic Baseboard Heater

THE RIGHT SOLUTION

WHY FAN-FORCED HEAT

Quickest way to comfortably heat a space.

Delayed fan operation **eliminates cold blasts** into the space.

Variety of sizes and outputs for residential to large commercial projects.

WALL HEATERS | CEILING HEATERS | UNIT HEATERS



WHY CONVECTION HEAT

Fan-less airflow **minimizes circulation of dust and allergens.**

No moving parts for **quiet, easy-to-maintain comfort.**

Versatile controls for optimal **localized heating,** flexibility and **energy savings.**

ARCHITECTURAL CONVECTORS | BASEBOARD HEATERS
ARCHITECTURAL TRENCH HEATERS



WHY RADIANT HEAT

Energy efficient. Works like the sun—heats people and objects rather than the air.

Very **low maintenance** with no filters, ignitors or moving parts.

Clean and safe with no fumes, odors or combustion properties.

CEILING PANELS | INFRARED HEATERS | PORTABLE HEATERS



for unique places

MORE THAN HEAT

Need Air Circulation?

EXPLORE OPTIONS IN VENTILATION

Increase **energy efficiency** up to 30% by recirculating heat energy and reducing main HVAC system load.

With destratification effect, occupants **stay comfortable longer**.

Reverse fan direction in **summer months** for cooler air.



Need to Heat a Flexible Floorplan?

EXPLORE OPTIONS IN PORTABLE HEATERS

Sleek, **compact design** for effortless placement anywhere.

Ready out of the box: All cords and mounting included for easy installation.

Built in controls and **safety limits** for ultimate peace of mind.



Need to Heat Hard-to-Reach Spaces?

EXPLORE OPTIONS IN SPECIALTY HEATERS

Designed for **hard-to-reach** or **remote applications**.

Specially engineered for both **occupant comfort** and/or facility **freeze protection**.

Rugged, durable construction ideal for **long-lasting heat**.

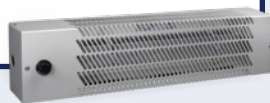

Need to Heat a Dangerous Environment?

EXPLORE OPTIONS IN HAZARDOUS HEATERS

Designed and constructed for the **most demanding environments**.

High quality, robust materials **built to last**.

Peace of mind with **safe and reliable** heat for any application.



No matter the industry or application, Marley Engineered Products has a robust portfolio of innovative, reliable, high-performance comfort heating and ventilation solutions for all your heating needs.

When it comes to comfort heating, contractors, architects, engineers and HVAC professionals trust Marley, the industry leader, for its residential, commercial and institutional heating solutions.

for safe comfort

Specialized comfort in all the right places

even in hard-to-heat spaces



Custom Capability Products Including



A product for hard-to-heat spaces

provides comfort in many essential places

WALL HEATERS

- 12 FRC Series
- 14 FRA Series
- 16 VFK SERIES
- 18 MFQ Series
- 20 SRA Series
- 22 GFR Series
- 24 SED Series
- 26 COS-E SERIES™
- 28 SSARWH Architectural SmartSeries®
- 30 SSHOWH Commercial SmartSeries®
- 33 HT Residential SmartSeries®

CEILING HEATERS

- 36 FFCH Series
- 38 QFF Series
- 40 QCH Series

UNIT HEATERS

- | | |
|---------------------|-------------------|
| 44 HUHAA Series | 55 GH48R Series |
| 48 HUHAA-PRO Series | 57 CUHS900 Series |
| 50 HUH Series | 60 BPH Series |
| 52 HUHTA/ST Series | 62 PHFP25 Series |
| 54 PH5HWAC Series | |

BASEBOARD

- 64 HBB Series
- 66 2500 Series
- 70 BKOC Series

RADIANT HEATERS

- 74 CP Series
- 76 RCC Series
- 76 VRP/VRS Series
- 82 Electric Control Panels
- 84 JRK Series
- 86 XRM Series

PORTABLE & SPECIALTY HEATERS

- | | |
|------------------|-----------------|
| 90 202SL Series | 96 FHP Series |
| 91 WHT500 Series | 97 FBE Series |
| 92 MMHD Series | 98 QTS Series |
| 93 MCM Series | 99 FDI Series |
| 94 NPH4A Series | 100 BDH Series |
| 95 BRH Series | 102 BSDH Series |

CEILING FANS

- 106 IHD Series (Industrial High-Efficiency)
- 107 CHD Series (Commercial High-Efficiency)

THERMOSTATS & CONTROLS

- 110 SmartSeries® Plus Digital Touchscreen Control
- 113 Electronic Digital Line Voltage
- 113 Electronic Digital Low Voltage
- 114 Line Voltage
- 115 Specialty Controls

Custom capability products

CEILING HEATERS

- 118 FFCH Series

UNIT HEATERS

- 120 HUHAA Series
- 123 HUHAA-PRO Series
- 127 CUH900 Series
- 129 Open Coil Electric Duct Heater

CONVECTORS

- | | |
|------------------------|-----------------|
| 133 THX™ Series | 143 CPL Series |
| 135 ASL3 & ASL5 Series | 145 CSL Series |
| 139 ASLC Series | 148 UCJ Series |
| 141 BDBSL Series | 150 ICST Series |

HAZARDOUS ENVIRONMENT PRODUCTS

- 153 BWD Series
- 155 RUX Series
- 157 SCG Series

RADIANT HEATERS

- 160 CP Series
- 163 VRP/VRS Series
- 164 Electric Control Panels



AIR CURTAINS

- 166 Environmental Series

Click on a product to jump to the specific page.

Catalog Guide

SKU Legend:

	Popular Products These products are our most commonly stocked items across channels to serve most applications in market. Usually available from inventory with standard lead times.
	Extended Offering Additional application coverage with features that may be more specific to your needs. Available with longer lead times compared to our standard stocking items.
	Made to Order These items are Made to Order configurations that are manufactured specific to your customization requirements and have longer lead times. Please contact your Marley Sales Representative for further details.

Certification Descriptions



These products are U.L. listed by Underwriters Laboratories, ensuring that the products have passed Underwriters Laboratories rigorous testing procedures to specific safety standards for electrical products and have assigned the appropriate listing number required for safety standards and electrical codes.



The CSA mark from the Canadian Safety Association is recognized and accepted throughout Canada and the US at federal, state, provincial, and municipal levels. It means that the product is certified to the applicable Canadian and US safety standards, respectively in Canadian and US markets.



A product bearing the c ETL US Listed mark signifies that it was tested and meets the minimum requirements of prescribed product safety standards for US and Canada. Moreover, the mark indicates that the manufacturer's production site conforms to a range of compliance measures and is subject to periodic follow-up inspections to verify continued conformance.

Standard Colors*

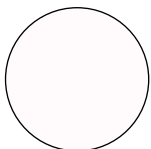

White

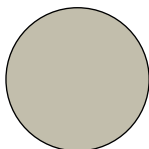

Beige

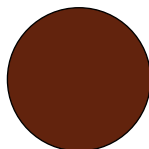

Bronze

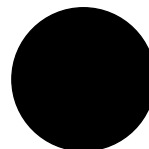

Black

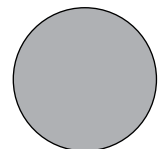

Aluminum

*Options vary by product

- Marley Engineered Products reserves the right to change or cancel this policy at any time, at its sole discretion without notice.
- For applications that require a primer coat, a Beige powder coat will be provided as standard color. Consult factory for more information.
- All colors are approximate (as nearly correct as can be produced by modern printing).
- Additional custom colors are available to order. Please contact your local QMark/Berko sales representative for additional details.
- There is a price adder for custom colors.
- To minimize the possibility of error when ordering material painted a custom color, a color chip of the custom color must be included with the order. The chip must be a minimum 3 x 5 in. and be of the same material as the enclosure of the ordered heater (ie. steel or aluminum).

Comfort when you need it, where you need it

Fan-forced wall heaters deliver efficiency and perform powerfully across both residential and commercial applications.

EVERY-DAY VALUE

*Commercial-grade construction
Wattage & voltage options
Expanded control offering*



COS-E

PROFESSIONAL VALUE

*Reliable, low cost solution
Limited output and control
Integrated thermostat to set
and forget*



GFR

AESTHETIC & COMFORT VALUE

*Superior aesthetic appeal
Optimized control solutions
Energy-efficient LCD screens**



SRA

Small Wall Heaters

Large Wall Heaters



FRA



FRC



SSARWH

*SmartSeries® Wall Heaters only



Electric wall heaters are great for entryways, dens, basements and bedrooms in residential applications as well as for larger areas in commercial applications such as hotels, restaurants and commercial office atriums.

FRC SERIES

Architectural Heavy-Duty Wall Heater

WALL HEATERS



Heavy-duty heat doesn't require that you settle for a boring, basic look. These architectural wall heaters feature a **striking design** while providing the **powerful output** you need to heat any room or open area.

Key Features:

Connect to Control

An optional relay is available to connect this wall heater to your Building Management System, for centralized control of your environment.

Contemporary Look

The bar-stock grille design provides an architectural accent that complements designed spaces like restaurants and entranceways.

Stay in Control

This unit's built-in thermostat features tamper-resistant protection, so only authorized personnel can make adjustments to your building's temperature levels.

Delay Operation

This wall heater has a fan delay feature that waits until the unit warms up to begin blowing air into the room. The fan keeps operating until the unit cools down, so you get maximum heating performance.

Ease of Maintenance

All units include a power on/off switch for added safety during maintenance, as well as a permanently lubricated and enclosed fan motor, creating long life and low maintenance needs.



Scan the QR code to access additional specs and features.

Technical Specifications:

Temp Range: 40°-90°F

CFM: 100

Ideal Spaces:

Vestibules & Entrance Ways
Lobbies
Hallways
Stairwells
Restaurants
Conference Rooms
Offices
Basements
Living/Family Room



Intertek

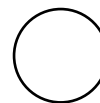

White

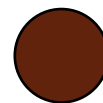

Bronze

Models & Specifications:

ITEM INFORMATION			ELECTRICAL DATA					SHIP WT.
CATALOG NO.	UPC	VOLTS	PHASE	WATTS	AMPS	BTUs		
◆ FRC1512F	685360161877	120	1	1500	12.5	5,118	25 lbs	
◆ FRC4307F	685360164755	277	1	3000/1500	10.8/5.4	10,236/5,118	25 lbs	
◆ FRC4024F	685360161990	208	1	3000/1500	14.4/7.2	10,236/5,118	25 lbs	
		240	1	4000/2000	16.7/8.3	13,649/6,824	25 lbs	
◆ FRC4027F	685360162072	240	1	3000/1500	12.5/6.3	10,236/5,118	25 lbs	
		277	1	4000/2000	14.4/7.2	13,649/6,824	25 lbs	
◆ FRC4020F	685360162119	208	1	4000/2000	19.2/9.6	13,649/6,824	25 lbs	
◆ FRC4824F	685360162195	208	1	3600	17.3	12,284	25 lbs	
		240	1	4800	20	16,378	25 lbs	
◆ FRC4827F	685360162270	240	1	3600	15	12,284	25 lbs	
		277	1	4800	17.3	16,378	25 lbs	
◆ FRC4820F	685360162317	208	1	4800	23.1	16,378	25 lbs	
● FRC4303F	685360164038	347	1	3000	8.6	10,236	25 lbs	
● FRC4306F	685360164069	600	1	3000	5	10,236	25 lbs	
● FRC4503F	685360164113	347	1	4800	13.8	16,378	25 lbs	
● FRC4506FC	685360164144	600	1	4800	8	16,378	25 lbs	
● FRC1812F	685360161891	120	1	1800	15	6,142	25 lbs	
● FRC40243F	685360162034	240	3	4000	9.6	13,649	25 lbs	
● FRC40203F	685360162157	208	3	4000	11.1	13,649	25 lbs	
● FRC45043F	685360164762	240	3	4800	11.6	16,378	25 lbs	
● FRC48203F	685360162355	208	3	4800	13.3	16,378	25 lbs	

SKU Legend: ◆ = Popular Products; ● = Extended Offering (Contact your local Marley Sales Representative for typically associated lead times)

NOTE: Factory-wired for higher wattage, field-convertible to half wattage. Units not available to be wired with remote thermostats. Standard finish is Bronze; For White, add NW suffix to catalog number.

Optional Accessories:

CATALOG NO.	UPC	DESCRIPTION	SHIP WT.
FRPE*	685360028224	Pneumatic/Electric switch. Factory set at 10 PSIG to "make" on pressure drop. May be field wired to "break" on pressure drop. Pressure set point adjustable to 30 PSIG. (field-installed)	2 lbs
FRR2 (24V)*	685360030364	Time delay relay 40-60 seconds to close when energized. Use 120V or 24V power supply from remote source (field-installed)	2 lbs
FRR12 (120V)*	685360030357		
FRS1PB	685360030401	1 in. deep surface mounting frame for semi-recessed installation, Statuary Bronze	2 lbs
FRS2PB	685360030425	2 in. deep surface mounting frame for semi-recessed installation, Statuary Bronze	2 lbs
FRSMPB	685360030388	Surface mounting frame for surface installations. Painted to match heater decor, 3 1/16 in. deep, Statuary Bronze	5 lbs
VFKSFCNW	685360074665	14-gauge security front cover, White	6 lbs

Note: *Will accommodate pneumatic/electric or low-voltage controls commonly used with computerized energy management systems Mounting Limitations: For wall mounting, do not install back box closer than 8 in. from floor or adjacent wall. Do not install heater behind towel rack, behind door, in floor, in closet, in ceiling or where air flow may be obstructed. All controls are concealed behind the front cover making them essentially tamper proof.

Dimensions and Clearances:

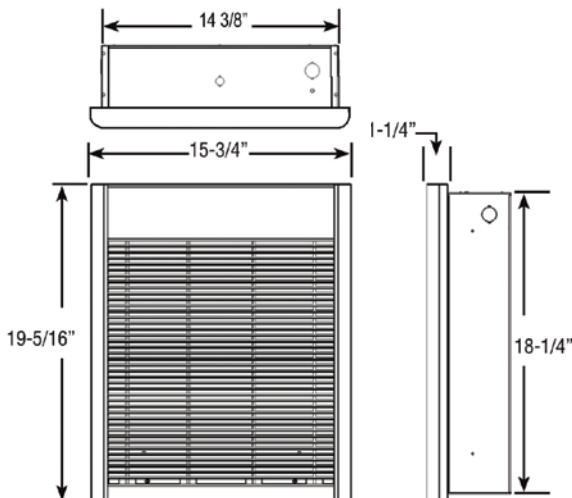

FRA SERIES

Commercial Fan-Forced Large Wall Heater

WALL HEATERS



With a durable commercial-grade steel grille, this heater delivers **optimized airflow** to homes, basements, offices, conference rooms, lobbies, hallways and vestibules, for wall-mounted, fan forced comfort **wherever you need it.**

Key Features:

Cool Running

Set this commercial wall heater to fan only mode for added air circulation or to keep things cool during the warmer months.

Delay Operation

This wall heater has a fan delay feature that waits until the unit warms up to begin blowing air into the room. The fan keeps operating until the unit cools down, so you get maximum heating performance.

Set Your Temp

This commercial wall heater features an integrated double-pole thermostat for easy temperature adjustment whenever you need to make a change.

Perpetual Protection

This wall heater features a permanently lubricated fan motor, so it will be ready for long-term operation with little required maintenance.

Technical Specifications:

Temp Range: 40°-90°F

CFM: 100

Ideal Spaces:

Mechanical Spaces
Vestibules & Entrance Ways
Lobbies
Hallways & Stairwells
Restaurants
Conference Rooms
Medical Offices
Basements
Living/Family Room



Intertek

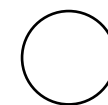

White



Scan the QR code to access additional specs and features.

Models & Specifications:

ITEM INFORMATION			ELECTRICAL DATA					SHIP WT.
CATALOG NO.	UPC	VOLTS	PHASE	WATTS	AMPS	BTU/HR		
◆ FRA1512F	685360162393	120	1	1500	12.5	5,118	25 lbs	
◆ FRA4024F*	685360162478	240	1	4000/2000	16.7/8.3	13,649/6,824	25 lbs	
		208	1	3000/1500	14.5/7.2	10,236/5,118	25 lbs	
◆ FRA4027F*	685360162492	277	1	4000/2000	14.5/7.2	13,649/6,824	25 lbs	
		240	1	3000/1500	12.5/6.3	10,236/5,118	25 lbs	
◆ FRA4020F*	685360162539	208	1	4000/2000	19.2/9.6	13,649/6,824	25 lbs	
◆ FRA4824F	685360162577	240	1	4800	20	16,378	25 lbs	
		208	1	3600	17.3	12,284	25 lbs	
◆ FRA4827F	685360162591	277	1	4800	17.3	16,378	25 lbs	
		240	1	3600	15	12,284	25 lbs	
◆ FRA48203F	685360162614	208	3	4800	13.4	16,378	25 lbs	
◆ FRA4820F	685360162638	208	1	4800	23.1	16,378	25 lbs	
● FRA1812F	685360162416	120	1	1800	15	6,142	25 lbs	
● FRA3027F*	685360162430	277	1	3000/1500	10.8/5.4	10,236/5,118	25 lbs	
● FRA40243F	685360162454	240	3	4000	9.7	13,649	25 lbs	
● FRA40203F	685360162515	208	3	4000	11.1	13,649	25 lbs	
● FRA48243F	685360162553	240	3	4800	11.6	16,378	25 lbs	
● FRA3153F	685360164236	347	1	1500	4.3	5,118	25 lbs	
● FRA3203F	685360164199	347	1	2000	5.8	6,824	25 lbs	
● FRA3303F	685360164274	347	1	3000	8.6	10,236	25 lbs	
● FRA3403F	685360164311	347	1	4000	11.5	13,649	25 lbs	
● FRA3503F	685360164359	347	1	4800	13.8	16,378	25 lbs	
● FRA3156F	685360164250	600	1	1500	2.5	5,118	25 lbs	
● FRA3206F	685360164212	600	1	2000	3.3	6,824	25 lbs	
● FRA3306F	685360164298	600	1	3000	5	10,236	25 lbs	
● FRA3406F	685360164335	600	1	4000	6.7	13,649	25 lbs	
● FRA3506F	685360164373	600	1	4800	8	16,378	25 lbs	

SKU Legend: ◆ = Popular Products; ● = Extended Offering (Contact your local Marley Sales Representative for typically associated lead times)

*Factory-wired for higher wattage, field-convertible to half wattage. For wall mounting - Do not install back box closer than 8 in. from floor or adjacent wall. Do not install heater behind towel rack, behind door, in floor, in closet, in ceiling or where air flow may be obstructed.

Optional Accessories:

CATALOG NO.	UPC	DESCRIPTION	SHIP WT.
FRAFCTPF	685360027104	Tamper-Proof Front Cover, White	2 lbs
SMFL	685360174433	Surface Mounting Frame, White	5 lbs
SMFL1	685360174440	1 in. Semi-Recessed Frame, White	2 lbs
SMFL2	685360174457	2 in. Semi-Recessed Frame, White	2 lbs
VFKFSCNW	685360160801	14-gauge Security Front Cover, White	6 lbs

Dimensions and Clearances:

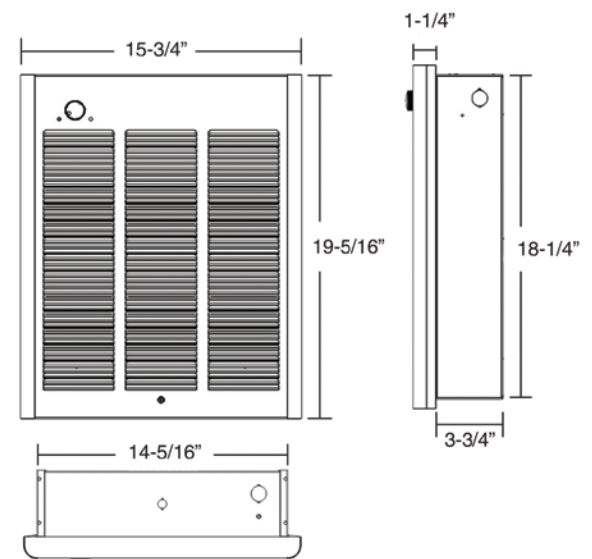

VFK SERIES

Commercial Fan-Forced Wall Heater

WALL HEATERS



For **wide open spaces** like entryways and vestibules, basements, playrooms and mechanical areas, this unit provides **fast-acting heat**.

Key Features:

High-Capacity Heat

4800 watts of power provide fast-acting, robust heat right where you need it, with no need for venting or exhaust.

Safe Operation

The unit's safety protection will shut the unit off before it overheats if the unit is accidentally blocked.

Long-Lasting Performance

Prolongs the life of the heating element by keeping the fan off until the element is at the proper temperature.

Convenient Control

A factory-installed, double-pole thermostat with a positive ON/OFF position is included for easy installation and convenient control.

Technical Specifications:

Temp Range: 40°-90°F

CFM: 100

Ideal Spaces:

Mechanical Rooms
Vestibules & Entrance Ways
Lobbies & Hallways
Hotel Stairwells
Restaurants & Medical Offices
Conference Rooms
Basements
Living/Family Rooms



Intertek

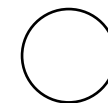

White



Scan the QR code to access additional specs and features.

VFK SERIES

Commercial Fan-Forced Wall Heater

WALL HEATERS

Models & Specifications:

ITEM INFORMATION			ELECTRICAL DATA					SHIP WT.
CATALOG NO.	UPC	VOLTS	PHASE	WATTS	AMPS	BTU/HR		
◆ VFK151F	685360162690	120	1	1500/750	12.5	5118/2559	22 lbs	
◆ VFK204F	685360162713	240	1	2000	8.3	6824	22 lbs	
		208	1	1500	7.2	5118	22 lbs	
◆ VFK404F	685360161808	240	1	4000/2000	16.7	13,649/6824	22 lbs	
		208	1	3000/1500	14.4	10,236/5118	22 lbs	
◆ VFK484F	685360162874	240	1	4800/2400	20	16,378/8189	22 lbs	
		208	1	3600/1800	17.3	12,284/6142	22 lbs	
● VFK304F	685360162751	240	1	3000/1500	12.5	10,236/5118	22 lbs	
		208	1	2250/1125	7.2	7677/3839	22 lbs	
● VFK408F	685360162836	208	1	4000/2000	19.2	13,649/6824	22 lbs	
● VFK4083F	685360162812	208	3	4000	11.1	13,649	22 lbs	
● VFK487F	685360162911	277	1	4800/2400	17.3	16,378/8189	22 lbs	
		240	1	3600/1800	15	12,284/6142	22 lbs	
● VFK488F	685360162959	208	1	4800	23.1	16,378	22 lbs	
● VFK4883F	685360162935	208	3	4800	13.3	16,378	22 lbs	
● VFK303F	685360162737	347	1	3000	8.6	10236	22 lbs	
● VFK403F	685360161822	347	1	4000	11.5	13,649	22 lbs	
● VFK483F	685360162850	347	1	4800	13.8	16,378	22 lbs	
● VFK306F	685360161815	600	1	3000	5	10,236	22 lbs	
● VFK406F	685360162799	600	1	4000	6.7	13,649	22 lbs	
● VFK486F	685360162898	600	1	4800	8	16,378	22 lbs	

SKU Legend: ◆ = Popular Products; ● = Extended Offering (Contact your local Marley Sales Representative for typically associated lead times)

Optional Accessories:

CATALOG NO.	UPC	DESCRIPTION	SHIP WT:
VFKSFCNW	685360160801	14-Gauge Security Front Cover, White	6 lbs
SMFL	685360174433	Surface Mounting Frame For Surface Installations. 3 1/16" Deep, White	1 lbs
SMFL1	685360174440	1 in. Deep Surface Mounting Frame For Semi-Recessed Installation, White	1 lbs
SMFL2	685360174457	2 in. Deep Surface Mounting Frame For Semi-Recessed Installation, White	1 lbs

Dimensions and Clearances:

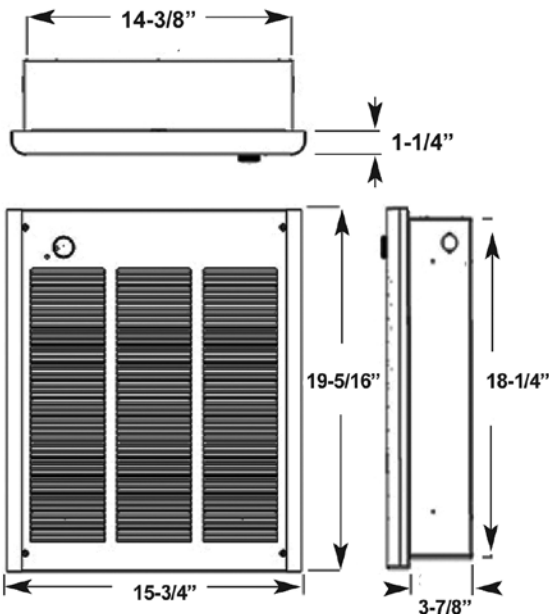

MFQ SERIES

High Output Commercial Fan-Forced Wall Heater

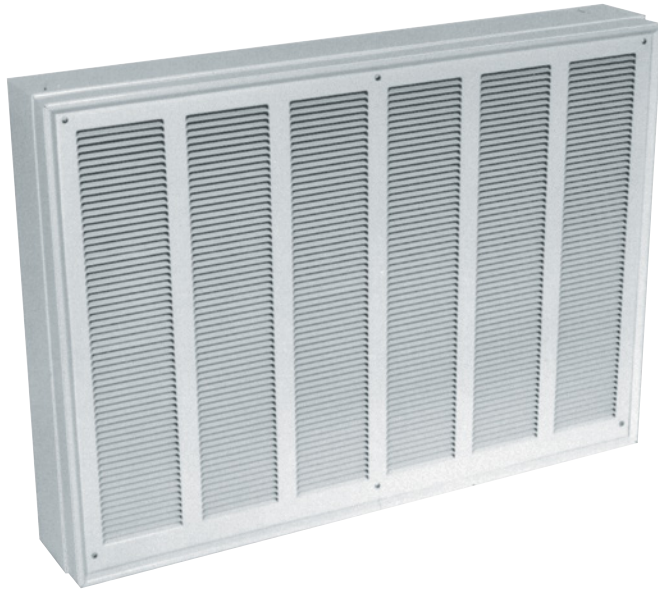

WALL HEATERS

When **high output** and **extra CFM** are needed, look no further than the MFQ series wall heater. This commercial fan-forced heater is ideal for spaces that need the extra output or extra throw into the space. Whether a school, hospital, or other public space, the MFQ series is perfectly suited.

Key Features:

Cover Protection

The stamped-steel front cover of this commercial fan-forced heater provides added durability to stand up to the wear and tear of high-traffic commercial spaces.

Safer Operation

This commercial fan-forced wall heater offers built-in overheat protection, keeping building occupants safe and more comfortable.

Maintenance Made Easy

The heater comes equipped with a simple on/off switch, so it can be completely turned off for easy servicing and routine maintenance.

Technical Specifications:

Temp Range: 60°-90°F

CFM: 200

Ideal Spaces:

Offices
Stores, Schools & Churches
Hospitals & Waiting Rooms
Dormitories
Airport Terminals
Reception Rooms
Lobbies, Corridors & Stairwells
Conference Rooms
Hallways



Intertek

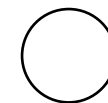

White



**Scan the QR code to access
additional specs and features.**

MFQ SERIES

High Output Commercial Fan-Forced Wall Heater

WALL HEATERS

Models & Specifications:

ITEM INFORMATION		ELECTRICAL DATA							SHIP WT.
CATALOG NO.	UPC	VOLTS	PHASE	WATTS	BTUs	AMPS	BUILT-IN THERMOSTAT		
● MFQ6008	685360046877	208	1	6000	20,525	28.8	Yes	50 lbs	
● MFQ60048	685360046846	480	1	6000	20,525	12.5	Yes	50 lbs	
● MFQ8008	685360046938	208	1	8000	27,368	38.5	Yes	50 lbs	
● MFQ8004	685360046891	240	1	8000	27,368	33.3	Yes	50 lbs	
● MFQ80048	685360046907	480	1	8000	27,368	16.7	Yes	50 lbs	

SKU Legend: ● = Popular Products; ● = Extended Offering (Contact your local Marley Sales Representative for typically associated lead times)

Optional Accessories:

CATALOG NO.	UPC	DESCRIPTION	SHIP WT.
MFQSM	685360046792	Surface Mounting Frame	6 lbs
MFQS1	685360046808	1 in. Semi-Recess Frame	5 lbs
MFQS2	685360046815	2 in. Semi-Recess Frame	6 lbs
MFQR24	685360046785	24V Power Relay	1 lbs
MFQR120	685360046778	120V Power Relay	1 lbs

Dimensions and Clearances:

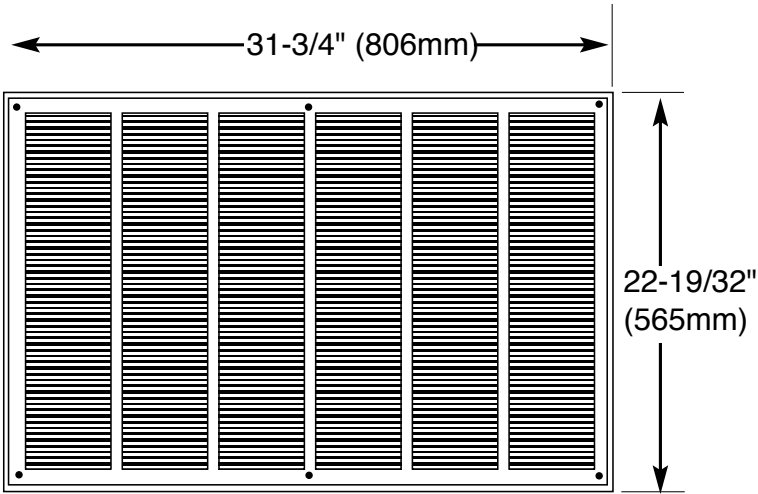

Back box dimensions 30-3/8" (771mm) wide x 21-1/4" (540mm) high x 3-3/4" (95mm) deep.

SRA SERIES

Commercial Fan-Forced Small Wall Heater

WALL HEATERS



Built with both durability and aesthetics in mind, the SRA series heaters offer a lot, in a **small package**. Whether a waiting room, small stairwell, office, or basement, this unit offers extra warmth, robust construction, and **aesthetic appeal** to meet the needs of your building's occupants.

Key Features:

Aesthetic Appeal

This series comes with two different grille finishes that will fit the space's design, while optimizing airflow.

Maintenance Made Easy

The heater comes equipped with a simple on/off switch, so it can be completely turned off for easy servicing and routine maintenance.

Delay Operation

This wall heater has a fan delay feature that waits until the unit warms up to begin blowing air into the room. The fan keeps operating until the unit cools down, so you get maximum heating performance.

Easy Temperature Adjustment

With an integrated thermostat included, this wall heater can quickly and easily be set to maintain your ideal comfort level.

Perpetual Protection

This wall heater features a permanently lubricated fan motor, so it will be ready for long-term operation with little required maintenance.

Technical Specifications:

Temp Range: 40°-90°F

CFM: 65

Ideal Spaces:

Vestibules
Entrance Ways & Lobbies
Hallways & Stairwells
Restaurants
Conference Rooms
Offices
Basements
Living/Family Room
Bedrooms

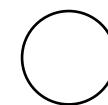

White

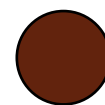

Bronze



Scan the QR code to access additional specs and features.

SRA SERIES

Commercial Fan-Forced Small Wall Heater

WALL HEATERS

Models & Specifications:

ITEM INFORMATION					ELECTRICAL DATA					SHIP WT.
WHITE GRILLE		ARCHITECTURAL GRILLE*			VOLTS	PHASE	WATTS	AMPS	BTU/HR	
CATALOG NO.	UPC	CATALOG NO.	UPC							
◆ SRA1512DSF	685360163918	SRA1512DSAF	685360162997		120	1	1500/750	12.5/6.25	5120/2560	12 lbs
◆ SRA2024DSF	685360163970	SRA2024DSAF	685360163079		240	1	2000/1000	8.3/4.2	6826/3413	12 lbs
					208	1	1500/750	7.2/3.6	5120/2560	12 lbs
◆ SRA2027DSF	685360163994	SRA2027DSAF	685360163093		277	1	2000/1000	7.2/3.6	6826/3413	12 lbs
					240	1	1500/750	6.25/3.2	5120/2560	12 lbs
◆ SRA2020DSF	685360164014	SRA2020DSAF	685360163055		208	1	2000/1000	9.6/4.8	6826/3413	12 lbs
● SRA1012DSF	685360163895	SRA1012DSAF	685360162973		120	1	1000/500	8.4/4.2	3413/1706	12 lbs
● SRA1527DSF	685360163932	SRA1527DSAF	685360163017		277	1	1500/750	5.4/2.7	5120/2560	12 lbs
					240	1	1125/562	4.7/2.4	3840/1920	12 lbs
● SRA1812DSF	685360163956	SRA1812DSAF	685360163031		120	1	1800	15	6143	12 lbs

SKU Legend: ◆ = Popular Products; ● = Extended Offering (Contact your local Marley Sales Representative for typically associated lead times)

Optional Accessories:

CATALOG NO.	UPC	DESCRIPTION	COLOR	SHIP WT.
SMFS	685360174402	Surface Mounting Frame. Order Separately. 12 1/2" H x 10 3/8" W x 4" D	White	3 lbs
CWHSMAG	685360148526	Surface Mounting Frame. Order Separately. 12 1/2" H x 10 3/8" W x 4" D	Bronze	3 lbs
SMFS1	685360174419	1 in. Semi-Recess Mounting Frame, 12 1/2" H x 10 3/8" W x 1" D	White	3 lbs
CWHS1AG	685360148533	1 in. Recess Mounting Frame. Order Separately	Bronze	3 lbs
SMFS2	685360174426	2 in. Semi-Recess Mounting Frame, 12 1/2" H x 10 3/8" W x 2" D	White	3 lbs
CWHS2AG	685360148540	2 in. Recess Mounting Frame. Order Separately	Bronze	3 lbs
SRAFCTPF	685360164977	Tamper-Resistant Front Cover	White	1 lbs

Dimensions and Clearances:

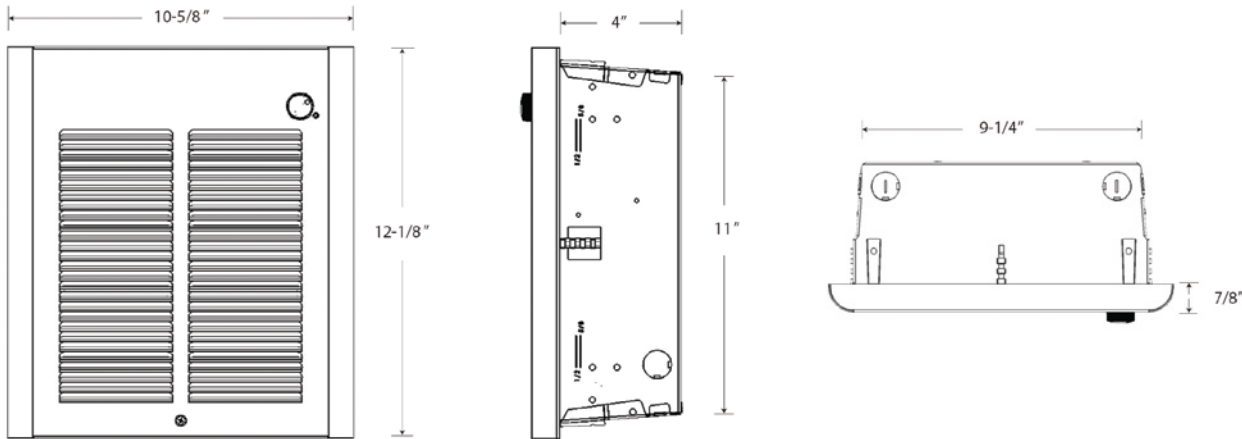

GFR SERIES

Fan-Forced Register Style Wall Heater

WALL HEATERS



Commercial-grade heating in your home. This **quiet, fast-acting** heater is built to resemble a standard home heating vent. Its simple 3-piece construction makes it **easy to install**, and the CLIP-N-FIT® jumper system allows for easy adjustment of the heater's wattage level.

Key Features:

Home Heating

The unit can be wired to a remote thermostat and to provide rapid, quiet heating for spaces like offices, playrooms, bedrooms and baths.

Quiet Operation

Enjoy reliable air circulation and heating with this unit's quiet tangential blower.

Easy Installation

The unit is easy to install, with just three pieces to assemble (back box, fan deck and front grille). The register-like front grille offers a built-in look that resembles a traditional heat vent.

Field Adaptable

Patented CLIP-N-FIT design allows you to lower the wattage at the point of installation to accommodate any space. Just clip out unnecessary jumpers and install.

Prevent Problems

For safe long-term operation, a thermal cutout feature with indicator light and one-time thermal fuse offer dual protection and prevent this model from overheating.



Scan the QR code to access additional specs and features.

Technical Specifications:

Temp Range: 40°-85°F

CFM: 50

Ideal Spaces:

Bedrooms
Living/Family Room
Kitchens
Bathrooms
Basements
Offices
Conference Rooms
Waiting Rooms

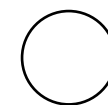

White

GFR SERIES

Fan-Forced Register Style Wall Heater

WALL HEATERS

Models & Specifications:

ITEM INFORMATION			ELECTRICAL DATA				
CATALOG NO.	UPC	VOLTS	WATTS	AMPS	BUILT-IN THERMOSTAT	SHIP WT.	
◆ GFR1500T2F	685360033693	120	1500/1125/750/375	12.5/9.4/6.3/3.1	Double Pole	11 lbs	
◆ GFR2004T2F	685360033747	240*	2000/1500/1000/500	8.3/6.3/4.2/2.1	Double Pole	11 lbs	
◆ GFR2404T2F	685360033778	240*	2400/1800/1200/600	10.0/7.5/5.0/2.5	Double Pole	11 lbs	

SKU Legend: ◆ = Popular Products; ● = Extended Offering (Contact your local Marley Sales Representative for typically associated lead times)

NOTE: For wall mounting only. Do not install back box closer than 4 in. from floor, 6 in. from adjacent walls and 36 in. from the ceiling. Do not install heater behind towel rack, behind door, in floor, in closet, in ceiling or where airflow may be obstructed. To insure proper operation, maintain 5 ft. minimum clearance to furniture or other objects placed directly in front of the heater.

*Will operate on 208V at 75% of rated wattages. For installations over 7,500 ft. above sea level we recommend using models under 1500 watts. "T2F" Model are complete heater assemblies with grille, back box, and thermostat.

Optional Accessories:

CATALOG NO.	UPC	DESCRIPTION	SHIP WT.
GFRBB	685360033631	Single Backbox For GFR Series Heater	2 lbs
GFRBB6	685360033648	Multi-Pack Backbox (6Pcs)	10 lbs
GFRTSP	685360033624	Single-Pole Thermostat (Field-Installed)	1 lbs
GFRTDP	685360059259	Double-Pole Thermostat (Field-Installed)	1 lbs
GFRSM	685360059266	Surface Mounting Frame	2 lbs

Dimensions and Clearances:

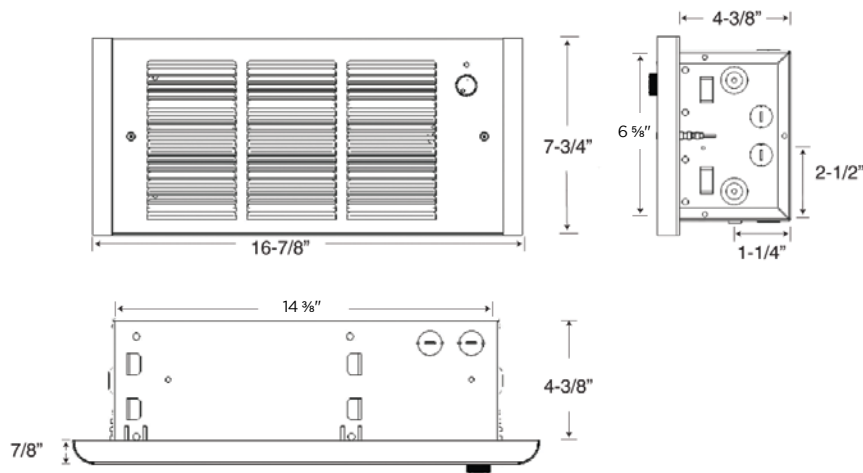

Suggested Controls



TH106A

MS26 or M601W

SED SERIES

Fan-Forced Small Wall Heater

WALL HEATERS



A unit **designed for commercial spaces** yet will fit perfectly in **residential applications**, where extra comfort and control are needed. With the right accessories, this unit can be installed on the **ceiling** or **surface-mounted** on the wall.

Key Features:

Shallow-mount Friendly

This fan-forced wall heater is best suited for shallow, recessed wall mounting. This makes it an ideal comfort solution for manufactured housing units and other spaces with thinner interior walls.

Localized Control

Use the built-in double pole thermostat or a remote, wall mounted thermostat for optimal room control.

Rapid Comfort

The heating element's open coil design warms up rapidly, so your room space does too. The simple design makes it easy to service and maintain the heater.

Double Protection

A built-in thermal cutout and one-time thermal fuse provide dual levels of overheat protection, for safe long-term operation of this heating unit.

Repair in No Time

This wall heater's wiring compartment is accessible to repair persons in the field, making it easy to perform service on the unit with minimal disruption to the room.



Scan the QR code to access additional specs and features.

Technical Specifications:

Temp Range: 45°-90°F

CFM: 50

Ideal Spaces:

Bedrooms
Kitchens
Bathrooms
Basements
Offices
Hallways
Lobbies
Waiting Rooms

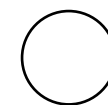

White

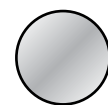

Stainless Steel

SED SERIES

Fan-Forced Small Wall Heater

WALL HEATERS

Models & Specifications:

ITEM INFORMATION			ELECTRICAL DATA						
CATALOG NO.	UPC	VOLTS	PHASE	WATTAGE	AMPS	BTU/HR	CEILING MOUNT	SHIP WT.	
◆ SED1012C*	68536081908	120	1	1000	8.3	3410	Yes	12 lbs	
◆ SED1512	68536081922	120	1	1500	12.5	5115	No	12 lbs	
◆ SED2024	68536081939	240/208	1	2000/1500	8.3/7.2	6820/5115	No	12 lbs	
● SED1012W	685360148885	120	1	1000	8.3	3410	Yes	12 lbs	
● SED1024C*	68536081915	240/208	1	1000/750	4.2/3.6	3410/2557	Yes	12 lbs	
● SED1024W	685360156989	240/208	1	1000/750	4.2/3.6	3410/2557	Yes	12 lbs	

SKU Legend: ◆ = Popular Products; ● = Extended Offering (Contact your local Marley Sales Representative for typically associated lead times)

NOTE: Units available in built in or wall mounted thermostats. *Stainless Steel models

Optional Accessories:

CATALOG NO.	UPC	DESCRIPTION	SHIP WT.
SEDSM	685360010431	White Surface Mounting Frame	3 lbs
SEDSMC	685360126173	Stainless Steel Surface Mounting Frame	3 lbs
SEDFCW	685360126166	Front Cover – White	2 lbs
SEDFCC	685360126159	Front Cover – Stainless Steel	2 lbs

COS-E SERIES™

Residential Fan-Forced Zonal Wall Heater

WALL HEATERS



True zonal heating in a compact design that fits in anywhere. Its **fast-response heating element** kicks in quickly, providing warmth for your bedroom, bathroom or hallway. The patented CLIP-N-FIT® system, thermal fuse and self-hold limit makes **installation safe and easy.**

Key Features:

Instant Heating

Patented CLIP-N-FIT feature allows installer to select the desired wattage with ease and therefore, warm up the room rapidly. Its fast-response element delivers warmth instantly.

Efficient Operation

Get reliable zonal heating without cold spots. The unit's multi-layer impeller delivers consistent airflow in an energy-efficient design

Suitable for Any Room

Compact design fits well in bathrooms, bedrooms and hallways for comfortable living all year round.

Localized Control

Use the built-in double pole thermostat with positive OFF, or a remote, wall mounted thermostat for optimal room control.

Dual Protection

This unit features a self-hold limit to protect against overheating, with a one-time thermal fuse backup.

Universal Design

Clean aesthetics and a compact frame make this heater an unobtrusive solution for any space.

Technical Specifications:

Temp Range: 40°-90°F

CFM: 50

Ideal Spaces:

Bedrooms
Living/Family Room
Kitchens
Basements
Offices
Conference Rooms
Waiting Rooms

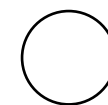

White



Scan the QR code to access additional specs and features.

Models & Specifications:

ITEM INFORMATION			ELECTRICAL DATA						SHIP WT.
CATALOG NO.	UPC	VOLTS (1)	VOLTS (2)	WATTS (1)	WATTS (2)	AMPS (1)	AMPS (2)		
◆ CZ1512T	685360161648	120	-	1500/750	-	12.5/6.3	-	11 lbs	
◆ CZ1012T	685360161655	120	-	1000/500	-	8.4/4.2	-	8.1 lbs	
◆ CZ1048T	685360161631	208	240	750/375	1000/500	7.2/3.6	8.4/4.2	11 lbs	
◆ CZ1548T	685360161624	208	240	1125/570	1500/750	5.4/2.7	6.3/3.2	5.6 lbs	
◆ CZ2048T	685360161617	208	240	1500/750	2000/1000	3.6/1.8	4.2/2.1	11 lbs	

SKU Legend: ◆ = Popular Products; ● = Extended Offering (Contact your local Marley Sales Representative for typically associated lead times)

Optional Accessories:

CATALOG NO.	UPC	DESCRIPTION	SHIP WT.
CZTDP	685360163321	Double-Pole Built-in Thermostat Kit (Range: 40-85°F)	1 lbs
CZSM	685360163352	Surface Mounting Frame	2 lbs
CZ2CRAKIT	685360165196	Retrofit Kit CRA to COS-E	2 lbs

Dimensions and Clearances:

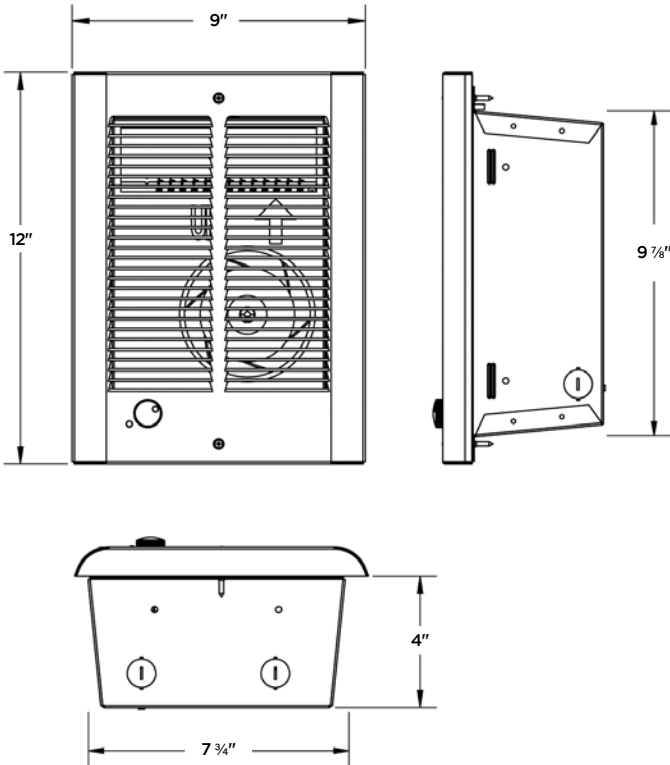

Suggested Controls



TH106A

M601W

Programmable Wall Heater



For superior aesthetic appeal and **energy-efficiency** that fits well in designed spaces, choose this SmartSeries® architectural wall heater. Combine the heavy duty die cast grille and 4800w output, and this unit is the **perfect accent** to any home, office, or restaurant.



Key Features:

Program Your Week

This wall heater features a hidden LCD touchscreen with 5/2 day programmable control, so you can set your heating pattern to best fit the way you live and work.

Command at Your Fingertips

With an included infrared remote control, you can activate, adjust and program this wall heater's thermostat from anywhere in the room.

Output on Demand

This wall heater features a two-speed fan, so you can fine-tune your heat output to your desired level quickly. A fan only mode and hold function provide additional flexibility, ventilation and comfort.

Connect to Control

This SmartSeries wall heater connects to your existing Building Management System for centralized control of your entire climate system.

Guaranteed Peace of Mind

A five-year warranty covers this wall heater's steel-plate finned element, for long-lasting performance you can trust for years to come.



Scan the QR code to access additional specs and features.

Technical Specifications:

Temp Range: 40°-90°F
CFM: 100

Ideal Spaces:

- Living Rooms
- Basements
- Lobbies
- Offices
- Conference Rooms
- Waiting Room
- Vestibules & Stairwells
- Restaurants

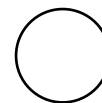

White

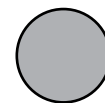

Aluminum

Programmable Wall Heater

Models & Specifications:

ITEM INFORMATION			ELECTRICAL DATA					SHIP WT.
CATALOG NO.	UPC	VOLTS	PHASES	WATTS	AMPS	BTU/HR		
◆ SSARWH1802	685360156842	120	1	900/1800	15	6,142	25 lbs	
◆ SSARWH4808	685360156767	208	1	1440/4800	23.1	16,378	25 lbs	
◆ SSARWH4804	685360156774	240	1	1440/4800	20	16,378	25 lbs	
◆ SSARWH4807	685360156804	277	1	1440/4800	17.3	16,378	25 lbs	

SKU Legend: ◆ = Popular Products; ● = Extended Offering (Contact your local Marley Sales Representative for typically associated lead times)

NOTE: For handling 208V Max AMP loads, contact your local Marley Sales Representative. Standard grille color is White. Add AL (Aluminum) suffix to catalog number of both the heater and mounting frame (ex. SSAR1802AL).
 Mounting Limitations: Do not install heater closer than 12 in. to the floor, 12 in. to an adjacent wall, 36 in. to the ceiling. Do not install heater behind towel rack or door, upside down or sideways, in the floor, in the ceiling, or in closets.

Optional Accessories:

CATALOG NO.	UPC	DESCRIPTION	SHIP WT.
HTWHSM	685360155456	Surface Mounting Frame 15 3/8" W x 19 3/16" H x 3 3/4" D	4 lbs
HTWHS1	685360155487	1 in. Semi-Recess Mounting Frame 15 3/8" W x 19 3/16" H x 1" D	4 lbs
HTWHS2	685360155517	2 in. Semi-Recess Mounting Frame 15 3/8" W x 19 3/16" H x 2" D	4 lbs

Dimensions and Clearances:

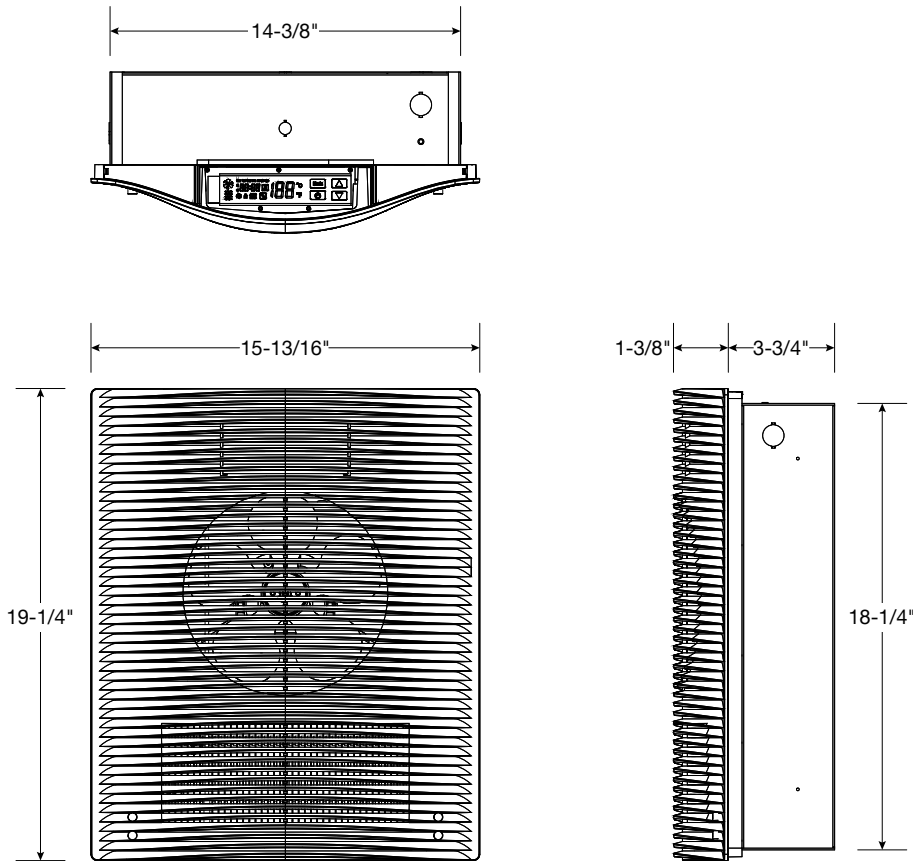

SSHOWH COMMERCIAL SMARTSERIES®

High-Output Wall Heater

WALL HEATERS



This SmartSeries® fan-forced wall heater provides a convenient way to program your finished attic, basement, garage or workspace for **year-round warmth and comfort**. Its SmartSeries technology includes an easy-to-read LED touch screen and a programmable thermostat with **separate settings for weekdays and weekends**. The heater is UL/CSA listed for worry-free installation and operation in your home or business.

Key Features:

Heat Any Room

Provides reliable heat for any room or entryway, even larger and odd shaped ones. Perfect for dens, basements and finished attics, workshops, garages, offices and bathrooms.

Auto Adjust

Automatically adjusts heat output and fan speed to help reduce energy costs and provide powerful, quiet climate control.

Long Life

Prolongs the life of the heating element by keeping the fan off until the element is at the proper temperature.

Easy Level Setting

The built-in thermostat features a 5/2 Day program so you can set different temperatures for weekday and weekend use.

Complete Control

LED touch screen provides easy access to settings and features, while the included remote control allows you to set temperatures from across the room.

Technical Specifications:

Temp Range: 40°-99°F

CFM: 100

Ideal Spaces:

Basements
Offices
Conference Rooms
Lobbies
Waiting Rooms
Entrance Ways
Vestibules
Restaurants
Stairwells

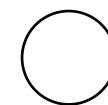

White



Custom Colors
Available



**Scan the QR code to access
additional specs and features.**

High-Output Wall Heater

Models & Specifications:

ITEM INFORMATION			ELECTRICAL DATA					
CATALOG NO.	UPC	VOLTS	PHASES	WATTS	AMPS	BTU/HR	SHIP WT.	
◆ SSHOWH4008	685360156705	208	1	1800/4000	8.7/19.2	13,650	26 lbs	
◆ SSHOWH4004	685360156729	240	1	1800/4000	7.5/16.7	13,650	26 lbs	
◆ SSHOWH4007	685360156736	277	1	1800/4000	6.5/14.4	13,650	26 lbs	

SKU Legend: ◆ = Popular Products; ● = Extended Offering (Contact your local Marley Sales Representative for typically associated lead times)

Optional Accessories:

CATALOG NO.	UPC	DESCRIPTION	SHIP WT.
HTWHSM	685360155456	Surface Mounting Frame 15 3/8" W x 19 3/16" H x 3 3/4" D	4 lbs
HTWHS1	685360155487	1 in. Semi-Recess Mounting Frame 15 3/8" W x 19 3/16" H x 1" D	4 lbs
HTWHS2	685360155517	2 in. Semi-Recess Mounting Frame 15 3/8" W x 19 3/16" H x 2" D	4 lbs

NOTE: See paint policy page for information on custom paint colors. Mounting Limitations: Do not install heater closer than 12 in. to the floor, 12 in. to an adjacent wall, 36 in. to the ceiling. Do not install heater behind towel rack or door, upside down or sideways, in the floor, in the ceiling, or in closets.

Dimensions and Clearances:

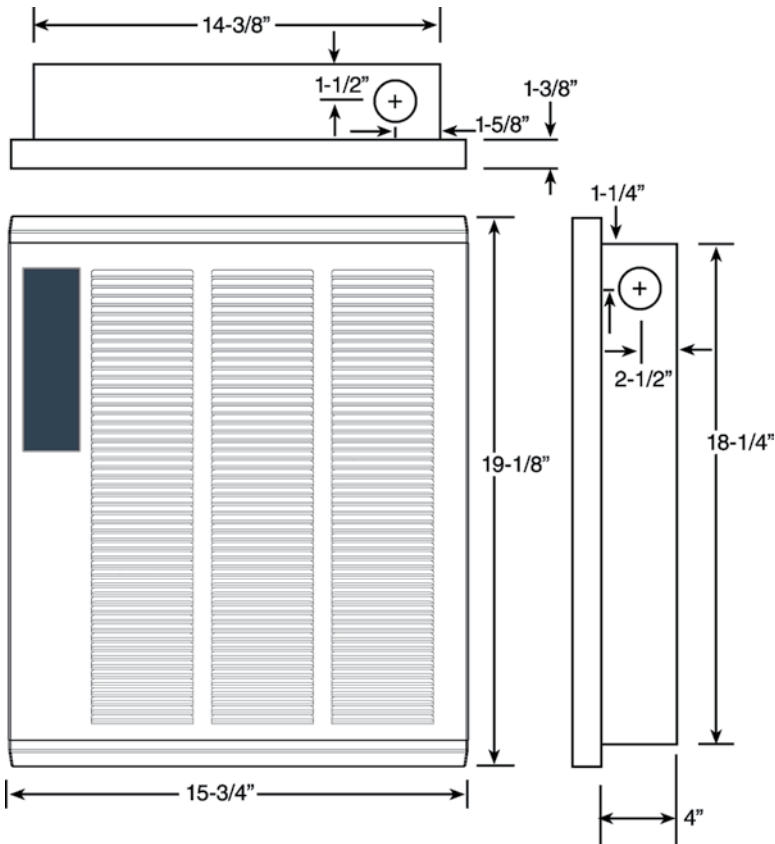

HT RESIDENTIAL SMARTSERIES®

Programmable Wall Heater

WALL HEATERS



This SmartSeries fan-forced wall heater provides a convenient way to program your attic, basement, garage or workspace for **year-round warmth and comfort**. Its SmartSeries technology includes an easy-to-read LED touch screen and a programmable thermostat with **separate settings for weekdays and weekends**. The heater is UL/CSA listed for worry-free installation and operation in your home or business.

Key Features:

Heat Any Room

Provides reliable heat for any room or entryway, even larger and odd shaped ones. Perfect for dens, basements and attics, workshops, garages, offices and bathrooms.

Auto Adjust

Automatically adjusts heat output and fan speed to help reduce energy costs and provide powerful, quiet climate control.

Long Life

Prolongs the life of the heating element by keeping the fan off until the element is at the proper temperature.

Easy Level Setting

The built-in thermostat features a 5/2 Day program so you can set different temperatures for weekday and weekend use.

Complete Control

LED touch screen provides easy access to settings and features, while the included remote control allows you to set temperatures from across the room.

Technical Specifications:

Temp Range: 40°-99°F

CFM: 100

Ideal Spaces:

Kitchens
Bathrooms
Basements
Offices & Waiting Rooms
Conference Rooms
Hallways
Lobbies
Entrance Ways
Vestibules

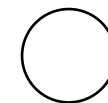

White

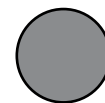

Gray



Scan the QR code to access additional specs and features.

Models & Specifications:

ITEM INFORMATION			ELECTRICAL DATA					SHIP WT.
CATALOG NO.	UPC	VOLTS	PHASES	WATTS	AMPS	BTU/HR		
◆ HT2024SS	685360153513	240	1	2500/2000	1.0/8.3	853/6826	20 lbs	
◆ HT1502SS	685360153506	120	1	2000/1500	1.6/12.5	682/5120	20 lbs	
● HT2024SSNW	685360158549	240	1	2500/2000	1.0/8.3	853/6826	27 lbs	
● HT1502SSNW	685360158525	120	1	2000/1500	1.6/12.5	682/5120	27 lbs	

SKU Legend: ◆ = Popular Products; ● = Extended Offering (Contact your local Marley Sales Representative for typically associated lead times)

Optional Accessories

CATALOG NO.	UPC	DESCRIPTION	SHIP WT.
SMHTSSSNW	685360156316	White Surface Mounting Frame, 14 5/8" W x 20 1/4" H x 3 3/4"	2.6 lbs
SMHTSSBL	685360156309	Black Surface Mounting Frame, 14 5/8" W x 20 1/4" H x 3 3/4" D	2.6 lbs

NOTE: Mounting Limitations: Do not install heater closer than 12 in. to the floor, 12 in. to an adjacent wall, 36 in. to the ceiling. Do not install heater behind towel rack or door, upside down or sideways, in the floor, in the ceiling, or in closets.

Dimensions and Clearances:

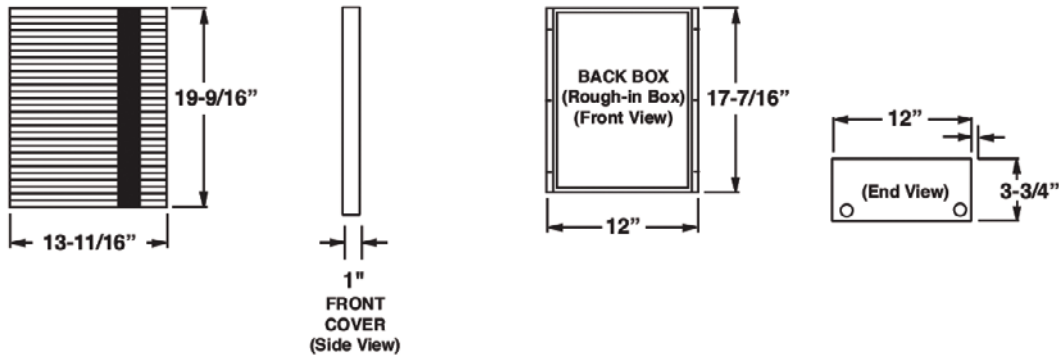

Limited floor space? Warm up with ceiling heat.

CEILING HEATERS

Ceiling mounted electric heaters add energy-saving warmth and comfort to any room.

EVERY-DAY VALUE

Great for Bathrooms and Offices

*Recessed and Surface
mounts available*

Dual Voltage and Wattage Models



QCH

PROFESSIONAL VALUE

Great for Medium Spaces

*Recessed, Surface, or
T-bar mounts available*

BMS Compatible



QFF

AESTHETIC & COMFORT VALUE

Great for Any Space

*Recessed, Surface, or
T-bar mounts available*

Multiple Airflow Options

BMS Compatible



FFCH

Mounted flat or recessed to the ceiling, ceiling heaters bring unobstructed comfort to your space.



FFCH SERIES

Commercial Downflow Ceiling Heater

CEILING HEATERS



For commercial spaces that need **unobtrusive comfort**, install this downflow ceiling heater. Deliver **powerful warmth** to your office, conference room, lobby, waiting room or entranceway.

Key Features:

Two Enclosures Available

Order a surface or recessed enclosure, depending on your ceiling type and available space. Surface mounting extends only 6 inches into the room, while the recessed enclosure requires only 7 inches of internal clearance.

Adjustable Airflow

Choose a narrow pattern to focus heat on one particular area, or a wide pattern to blanket more area. Asymmetrical heating patterns focus output while providing generous coverage.

BMS Compatibility

Optional relays allow you to connect this ceiling heater to your central building management system, so you can control temperatures from one location.

Easy Installation

Included thumb pins hold the unit together, freeing both hands for installation on the ceiling surface or within an enclosure.

Technical Specifications:

Temp Range: 45°-90°F

CFM: 300

Ideal Spaces:

- Bathrooms
- Offices
- Conference Rooms
- Lobbies
- Waiting Rooms
- Entrance Ways

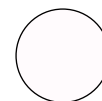

White

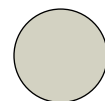

Navajo White

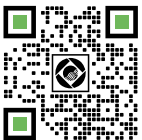

Scan the QR code to access additional specs and features.

FFCH SERIES

Commercial Downflow Ceiling Heater

CEILING HEATERS

Models & Specifications:

ITEM INFORMATION				ELECTRICAL DATA					SHIP WT.
CATALOG NO.	UPC	MOUNTING	KW	BTU/HR	AMPS	VOLTS	PHASE		
◆ FFCH548	685360026527	Heater Section Only	4/3/2	13.7/10.2/6.8	19.2/14.2/9.6	208	1-3	27 lbs	
◆ FFCH542	685360026503	Heater Section Only	4/3/2	13.7/10.2/6.8	16.7/12.5/8.3	240	1-3	27 lbs	
◆ FFCH547	685360026510	Heater Section Only	4/3/2	13.7/10.2/6.8	14.4/10.8/7.2	277	1	27 lbs	
◆ FFCH558	685360026558	Heater Section Only	5/3.8/2.5	17.1/13/8.5	24/18.3/12	208	1-3	27 lbs	
◆ FFCH552	685360026534	Heater Section Only	5/3.8/2.5	17.1/13/8.5	20.8/15.8/10.4	240	1-3	27 lbs	
◆ FFCH557	685360026541	Heater Section Only	5/3.8/2.5	17.1/13/8.5	18.1/13.7/9	277	1	27 lbs	

SKU Legend: ◆ = Popular Products; ● = Extended Offering (Contact your local Marley Sales Representative for typically associated lead times)

Optional Accessories:

CATALOG NO.	UPC	DESCRIPTION	SHIP WT.
FFCHSE	685360026435	Surface-mounted enclosure (Navajo White) – to be used With above heater section. 20" L x 16 1/2" W x 5 3/4" D	10 lbs
FFCHRE	685360026404	Recessed-mounted enclosure (Navajo White) – to be used With above heater section. 23 3/4" L x 23 3/4" W x 7" D	18 lbs
FFCHSEW	685360149625	Surface-mounted White – to be used With above heater section. 20" L x 16 1/2" W x 5 3/4" D	10 lbs
FFCHRENW	685360149646	Recessed-mounted White – to be used With above heater section. 23 3/4" L x 23 3/4" W x 7" D	18 lbs
FFCHT	685360026459	Integral thermostat SPST – Range 45 to 95°F	1 lbs
FFCH24R	685360026497	Relay (Time Delay 45-60 sec. to close when energized) requires 24V supply from remote source	1 lbs
FFCHR12	685360026428	Relay (Time Delay 45-60 sec. to close when energized) requires 120V supply from remote source	1 lbs
FFCHDS	685360026381	Power Disconnect Switch (3-Pole) 30 amps, 600 volts, 3Ø, 60 Hz	1 lbs
FFCHTK	685360026466	Trim Ring for mounting on permanent ceiling (cannot be factory installed)	1 lbs
FFCHTR4	685360026473	208/240V Primary Transformer/24V sec. and 24V holding coil control relay	1 lbs
FFCHTR7	685360026480	277V Primary Transformer/24V sec. and 24V holding coil control relay	1 lbs
FFCHRFK	685360171555	Mounting Bracket Retrofit Kit	2.5 lbs

NOTE: Factory-wired for highest wattage, field-convertible to lower wattages. Factory-wired 1-PH, field convertible to 3-PH dual-phase units, maximum amp draw is listed. Amperage shown is for single phase. For factory installation of above controls, additional charges apply.

Adjustable Airflow Options:

Wide Pattern

(24x8 ft. coverage)

In standard ceiling applications (8-10 ft.), heater disperses the air to give a gentle, less pronounced pattern while circulating all the air from floor to ceiling.

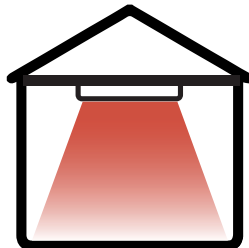

Narrow Pattern

(8x8 ft. coverage)

For high ceiling applications (11-14 ft.), fan concentrates the heated air to ensure full penetration to the floor level.

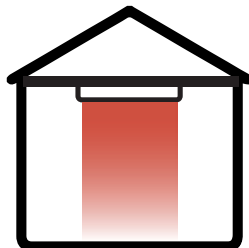

Asymmetrical Pattern

(17x10 ft. coverage)

Heated air is directed in a specific direction, allowing the heater to be located where space allows, with the heated air delivered to where it is required.

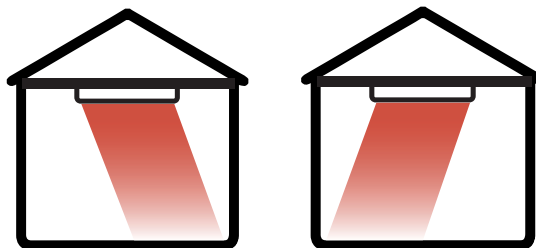

Suggested Controls



MS26 or M601W

QFF SERIES

Ceiling-Mounted Fan-Forced Heater

CEILING HEATERS



Anywhere it makes sense to keep your heating solution **out of the way** and **out of reach**, choose these fan-forced ceiling heaters. A comfort solution for lobbies, restrooms or detention environments.

Key Features:

Flexible Installation

This heater accommodates three installation formats, so you can choose recessed mounting, T-Bar or surface application.

Ready to Connect

This ceiling heater easily accommodates low voltage and electric control schemes like those typically found in centralized BMS applications.

Fan Delay

The heater's fan waits until the desired temperature is achieved before blowing air into the room, and discharges all residual heat before shutting off.

Enhanced Control

This ceiling heater has an included on/off switch for safe, simple installation and maintenance.

Heavy-duty Design

This ceiling heater's 14-gauge steel louvered grille is fastened with tamper-resistant screws, for added security and durability.

Technical Specifications:

Temp Range: 40°-90°F

CFM: 150

Ideal Spaces:

Hallways
Lobbies
Entryways
Restrooms
Detention Environments

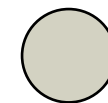

Navajo White

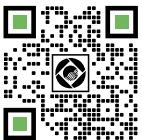

Scan the QR code to access additional specs and features.

QFF SERIES

Ceiling-Mounted Fan-Forced Heater

CEILING HEATERS

Models & Specifications:

ITEM INFORMATION			ELECTRICAL DATA					SHIP WT.
CATALOG NO.	UPC	VOLTS	PHASE	WATTS	AMPS	BTU/HR		
◆ QFF1500	685360148106	120	1	1500	12.5	5120	23 lbs	
◆ QFF3007	685360059075	277	1	3000/1500	10.8/5.4	10239/5120	23 lbs	
◆ QFF4008	685360059136	208	1	4000/2000	19.2/9.8	13652/6826	23 lbs	
◆ QFF4004	685360059099	240	1	4000/2000	16.7/14.4	13652/10239	23 lbs	
		208	1	3000/1500		10239/5120		
◆ QFF4007	685360059129	277	1	4000/2000	14.4/12.5	13652/10239	23 lbs	
		240	1	3000/1500		10239/5120		
◆ QFF4804	685360059167	240/208	1	4800/3600	20.0/17.3	16382/12287	23 lbs	
◆ QFF4807	685360059198	277/240	1	4800/3600	17.3/15.0	16382/12287	23 lbs	
● QFF48483	685360155845	480	3	4800	5.8	16382	23 lbs	
● QFF48483LV	685360155869	480	3	4800	5.8	16382	23 lbs	

SKU Legend: ◆ = Popular Products; ● = Extended Offering (Contact your local Marley Sales Representative for typically associated lead times)

NOTE: Factory-wired for highest wattage, field-convertible to lower wattages.

Optional Accessories:

CATALOG NO.	UPC	DESCRIPTION	SHIP WT.
QFFSM	685360058955	Surface Mounting Sleeve - Navajo White	6 lbs
QFFR2 (24V)	685360058948	Time delay relay, 45-60 seconds to close when energized; Uses remote 24V or 120V power source	1 lbs
QFFR12 (120V)	685360058931		
QFFTFB	685360058962	T-Bar Frame Kit	4.5 lbs
QFFT1	685360058993	Single Pole T-Stat. (Field Installed)	1 lbs
QFFT2	685360059006	Double Pole Thermostat. (Field Installed)	2 lbs
QFFTR4	685360058979	208/240V Primary Transformer 24V Relay	1 lbs
QFFTR7	685360058986	277V Primary 24V Sec. Transformer Relay	1 lbs

Dimensions and Clearances:

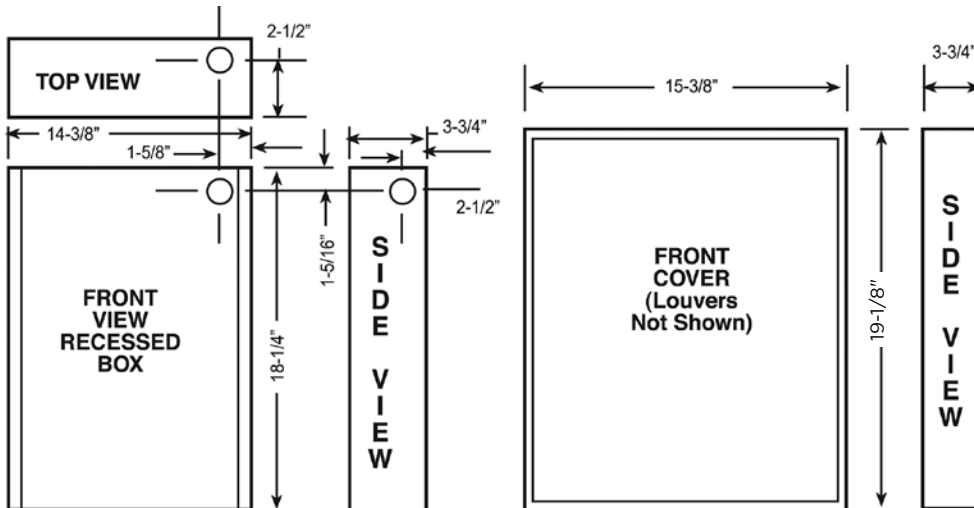

Suggested Controls



MS26 or M601W

QCH SERIES

Ceiling-Mounted Fan-Forced Heater

CEILING HEATERS

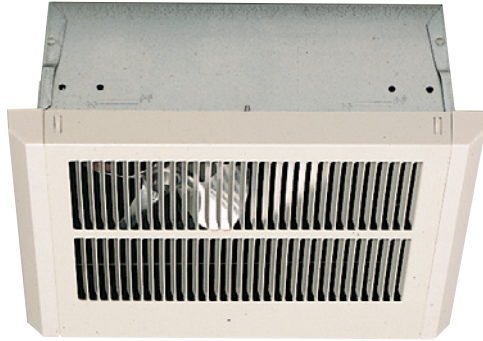

When **floor space is at a premium**, choose this fan-forced ceiling heater. It fits well in offices, bathrooms or lobbies, as well as attic and basement conversions.

Key Features:

Easy Installation

This heater features a simple, three-piece design for rapid installation, whether you choose a recessed mounting or surface application.

Safe Operation

For added safety, the included thermal cutout automatically shuts this heater down if it begins to overheat.

Fan Delay

The heater's fan waits until the desired temperature is achieved before blowing air into the room, and discharges all residual heat before shutting off.

Enhanced Control

This ceiling heater offers dual wattage/voltage models to best fit your onsite power requirements. Plus it has an included on/off switch for safe, simple installation and maintenance.

Technical Specifications:

Temp Range: 45°-95°F

CFM: 65

Ideal Spaces:

Basements
Offices
Converted Attics
Bathrooms
Workshops
Lobbies
Hallways
Common Areas



Intertek

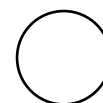

White

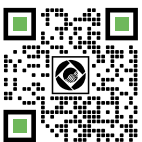

Scan the QR code to access additional specs and features.

QCH SERIES

Ceiling-Mounted Fan-Forced Heater

CEILING HEATERS

Models & Specifications:

ITEM INFORMATION			ELECTRICAL DATA			SHIP WT.
CATALOG NO.	UPC	VOLTS	WATTS	AMPS		
◆ QCH1101F	685360165028	120	1000	8.3	10 lbs	
			500	4.7	10 lbs	
◆ QCH1151F	685360165035	120	1500	12.5	10 lbs	
			750	6.3	10 lbs	
◆ QCH1202F	685360165042	240/208	2000/1500	8.3/7.2	10 lbs	
			1000/750	4.2/3.6	10 lbs	
◆ QCH1207F	685360165059	277/240	2000/1500	7.2/6.3	10 lbs	
			1000/750	3.6/3.1	10 lbs	

SKU Legend: ◆ = Popular Products; ● = Extended Offering (Contact your local Marley Sales Representative for typically associated lead times)
 NOTE: Factory-wired for highest wattage, field-convertible to lower wattages.

Optional Accessories:

CATALOG NO.	UPC	DESCRIPTION	SHIP WT.
QCHSM	685360058726	Surface mounting sleeve, White	2 lbs
QCHS1	685360058733	1 in. Semi-Recessed Frame, White	
QCHS2	685360058740	2 in. Semi-Recessed Frame, White	
QCHTBF	685360087382	T-Bar Frame Kit, White	5 lbs

NOTE: Requires two separate leads from heater to single-pole wall thermostat.

Dimensions and Clearances:

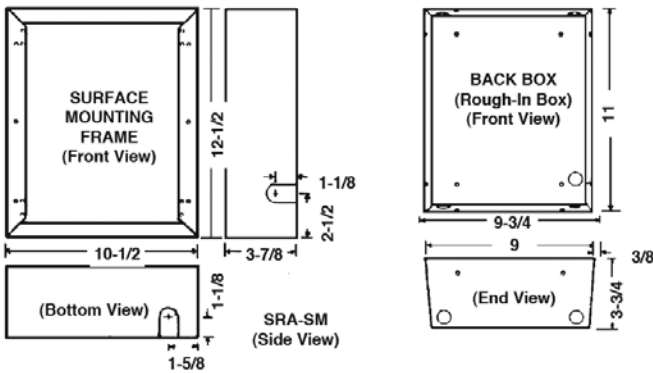

Warm up your workshop or warehouse with a unit heater

For spaces that need industrial-strength heating power, Unit Heaters deliver with powerful, energy-efficient draft protection.

EVERY-DAY VALUE

- Low cost*
- Quick installation*
- Remote control with automatic shut off*



GH48R

PROFESSIONAL VALUE

- Top seller*
- Robust design built for uniform heat distribution and longevity*



HUH524TA — HUH

AESTHETIC & COMFORT VALUE

- Fully customizable for ultimate comfort*
- Wide range of models and control options for any heating solution*



HUHAA

Specialized heaters designed for specified spaces.

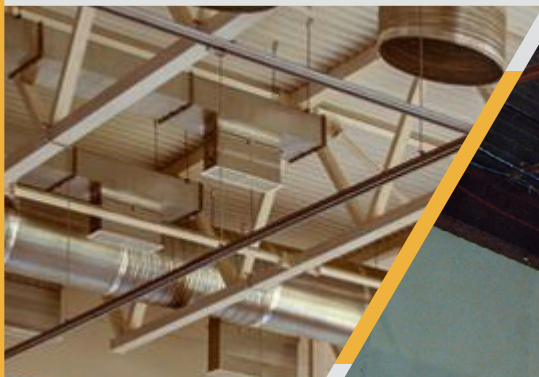

Duct Heat



Plenum Heat



Cabinet Unit Heat

Electric unit heaters are strong enough to be used for primary heat and are versatile enough to integrate with existing ductwork or in standalone settings. Specialized unit heaters fit into tight spaces with almost zero clearance.

Customizations AVAILABLE!*

*Customizations not available for all products.

HUHAA SERIES

Unit Heater

UNIT HEATERS



This **rugged** unit heater works well in industrial settings. Its **powerful output capacity** even makes it suitable for heating your loading dock or other indoor/outdoor transition spaces.

Dimensions and Clearances:

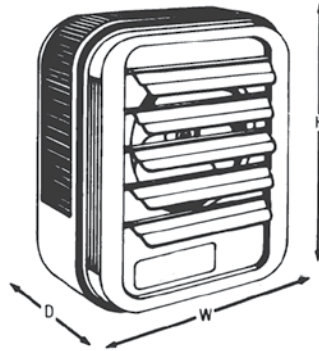

CATALOG NO.	HEIGHT	WIDTH	DEPTH
HUHAA03 & 05	16"	14"	7 ½"
HUHAA07 & 10	21 ¾"	19"	7 ½"
HUHAA15 & 20	21 ¾"	19"	12 ¾"
HUHAA25 & 30	30"	26 ⅝"	11 ¾"
HUHAA40 & 50	30"	26 ⅝"	17 ⅝"

Key Features:

Advanced Airflow

This unit heater's pull-through design draws air in across the heating element, so it runs cooler while providing an even blanket of comfort across its output range.

Safe Operation

A linear thermal cutout provides automatic protection the entire length of the heating element. Plus, most models feature a 24V control transformer for safer temperature adjustment.

Precise Positioning

The heater is equipped with individually adjustable louvers that aim your warmth where you need it most. A venturi outlet delivers the additional airflow you need to mount the unit vertically.

Three Times the Metal

The steel sheath heating element is clad in copper and outfitted with aluminum fins. This sophisticated design helps the heater run more safely and cool down faster.

Everything You Need for Installation

This unit heater doesn't require any piping flues, valves or traps. It's self-contained and ready to install wherever you need extra warmth.

Technical Specifications:

Temp Range: 40°-90°F

CFM: 350-3000

Ideal Spaces:

- Factories
- Warehouses
- Garages
- Stairwells
- Shipping Docks
- Power Stations
- Mechanical Rooms

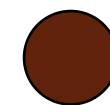

Bronze



Scan the QR code to access additional specs and features.

Models & Specifications:

ITEM INFORMATION			ELECTRICAL DATA					AIR DELIVERY DATA FAN MOTOR DATA	SHIP WT:
CATALOG NO.	UPC	VOLTS	PHASE	KW	AMPS	CONTROL VOLT	CFM		
◆ HUHAA320	685360036885	208	1	3	14.5	208	350	27 lbs	
◆ HUHAA520*	685360036977	208	1-3	5	24	208	350	27 lbs	
◆ HUHAA720	685360037011	208	1-3	7.5	36	24	650	38 lbs	
◆ HUHAA1020	685360036731	208	1-3	10	48	24	650	38 lbs	
◆ HUHAA1520	685360036779	208	1-3	15	72	24	910	53 lbs	
◆ HUHAA324	685360036892	208/240	1	2.2/3.0	11.0/12.5	208/240	350	27 lbs	
◆ HUHAA524*	685360036984	208/240	1-3	3.7/5.0	18.0/21.0	208/240	350	27 lbs	
◆ HUHAA724	685360037028	208/240	1-3	5.6/7.5	27.0/31.3	24	650	38 lbs	
◆ HUHAA1024	685360036748	208/240	1-3	7.5/10.0	36.0/42.0	24	650	38 lbs	
◆ HUHAA1524	685360036786	208/240	3	11.2/15.0	31.3/36.1	24	910	53 lbs	
◆ HUHAA327	685360036908	277	1	3	11	277	350	27 lbs	
◆ HUHAA527	685360036991	277	1	5	18	277	350	27 lbs	
◆ HUHAA727	685360037035	277	1	7.5	27	24	650	38 lbs	
◆ HUHAA348	685360036915	480	3	3	3.6	24	350	27 lbs	
◆ HUHAA548	68563047256	480	3	5	6	24	350	27 lbs	
◆ HUHAA748	68563047324	480	3	7.5	9	24	650	38 lbs	
◆ HUHAA1048	68563047386	480	3	10	12	24	650	38 lbs	
◆ HUHAA1548	68563047430	480	3	15	18	24	910	53 lbs	
● HUHAA2020	685360036809	208	3	20	56	24	1320	60 lbs	
● HUHAA2024	685360036816	208/240	3	15.0/20.0	41.2/48.0	24	1320	60 lbs	
● HUHAA2048	685360036823	480	3	20	24	24	1320	60 lbs	
● HUHAA2548	685360036847	480	3	25	30	24	2100/1800	93 lbs	
● HUHAA3048	685360036878	480	3	30	36	24	2100/1800	93 lbs	
● HUHAA4048	685360036939	480	3	40	48	24	3000/2600	114 lbs	
● HUHAA5048	685360036960	480	3	50	60.2	24	3000/2600	114 lbs	
● HUHAA3020	685360036854	208	3	30	84	24	2100/1800	93 lbs	
● HUHAA5020	685360036946	208	3	50	139	24	3000/2600	114 lbs	
● HUHAA2524	685360036830	208/240	3	18.7/25.0	52.0/60.0	24	2100/1800	93 lbs	
● HUHAA3024	685360036861	208/240	3	22.5/30.0	63.0/72.3	24	2100/1800	93 lbs	
● HUHAA4024	685360036922	208/240	3	30.0/40.0	83.4/96.4	24	3000/2600	114 lbs	
● HUHAA5024	685360036953	208/240	3	37.5/50.0	104.2/120.4	24	3000/2600	114 lbs	
● HUHAA1027	685360036755	277	1	10	36	24	650	38 lbs	

SKU Legend: ◆ = Popular Products; ● = Extended Offering (Contact your local Marley Sales Representative for typically associated lead times)

*Shipping weight includes mounting bracket

NOTE: All standard units are supplied with a low voltage control transformer and contactor (24V) except HUHAA3 and HUHAA5, 208V, 240V and 277V models. Low voltage control on these units is available on Made to Order (Contact your local Marley Sales Representative for typically associated lead times). If using low-voltage control, a 24v transformer is required. All units are also available on special order for 120V control; internal with transformer or external without transformer. On dual-voltage units CFM, FPM, & RPM ratings are listed at higher voltage operation. On dual-phase units maximum amp draw is listed for respective voltage. 25 thru 50 KW models having two-speed motors and dual CFM ratings are listed in Full Line Catalog. 5A. Standard; 5B. *Must use two-stage Thermostat on 3Ø operation.

HUHAA SERIES

Unit Heater

UNIT HEATERS

Optional Accessories:

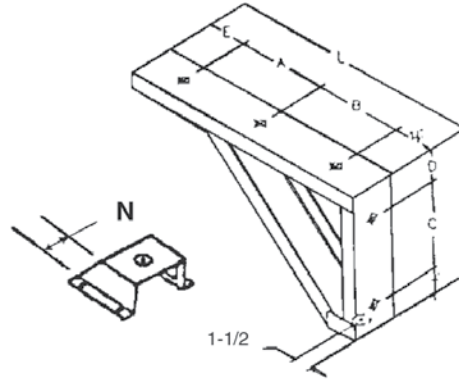
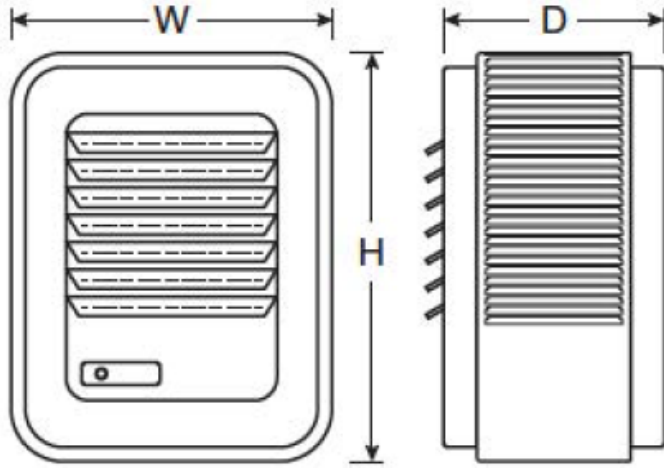

	3-20 kW	25-50 kW
A	7 1/4"	9 7/16"
B	9 1/2"	14 3/8"
C	7 1/4"	12 1/8"
D	11 15/16"	2 1/16"
E	2 1/4"	3"
L	20 1/2"	28 15/16"
M	9 15/16"	14 15/16"
N	3 1/4"	4 1/2"

Optional Mounting Brackets:

	CATALOG NO.	UPC	COMPATIBILITY	SHIP WT.†
Standard	B10	685360152295	MUH03-10	8 lbs
	MCB105PK	685360173627	(Master Pack, Five B10 Brackets)	
	B20	685360152301	MUH15 & 20	10 lbs
	B30	685360152318	MUH25 & 30	13 lbs
	B50	685360152325	MUH40 & 50	15 lbs
Ceiling	CMB10	685360152363	3-10 KW units	3 lbs
	CMB20	685360152370	15-20 KW units	4 lbs
	CMB30	685360152387	25-30 KW units	5 lbs
	CMB50	685360152394	40-50 KW units	6 lbs
Vertical Ceiling	VDMB5	685360152455	3-5 KW units	5 lbs
	VDMB20	685360152462	7.5-20 KW units	7 lbs
	VDMB50	685360152479	25-50 KW units	9 lbs

MOUNTING LIMITATIONS: Unit heaters should not be used in potentially explosive atmospheres. The finish is not intended for direct salt spray exposure in marine applications or the highly corrosive atmospheres of swimming pools, chemical storage bins, etc. Do not install unit heaters above recommended maximum mounting height. Obstructions must not block unit heater air inlet or discharge. Heaters must be mounted at least 7 ft. above the floor to prevent accidental contact with the heating element or fan blade which could cause injury.

Optional Dust Shields:

CATALOG NO.	UPC	COMPATIBILITY	SHIP WT.†
JRDS8	685360150697	3-5 KW units	5 lbs
JRDS14	685360150673	15-20 KW units	6 lbs
JRDS19	685360150680	25-50 KW units	10 lbs

Optional Field-Installed Electrical Controls:

CATALOG NO.	UPC	DESCRIPTION	ELECTRICAL RATING
UHMT1	685360152417	Single Pole Internal Thermostat-Temp Range: 40°- 85°F	25A @ 120, 240VAC Res. 22A @ 277VAC Res.
UHMT2	685360152424	Two Stage Internal Thermostat-Temp. Range: 40°- 85°F	25A @ 120, 240VAC Res. 22A @ 277VAC Res. 125VA
HUHAAFS	685360036618	Internal Summer Fan Switch 250, 480, 600V.A.C. 1,2 OR 3 PH	Pilot Duty 6A, 600VAC Res. 2 HP
HUHAARFS1	685360036717	Remote Summer Fan Switch (Line Voltage)	2 HP, 250-480VAC
HUHAARFS2	685360036724	Remote Summer Fan Switch with Relay (24V Coil-Single Pole Normally Open)	6 AFL, 35 ALR, 250VAC, 60Hz. 3 AFL, 18 ALR, 480VAC, 60Hz
HUHAAHRT	685360036625	Heat Recovery Thermostat with Relay (24V Coil-Single Pole Normally Open) Hi - 120°F, Low - 60°F	6 AFL, 35 ALR, 250VAC, 60Hz 3 AFL, 18 ALR, 480VAC, 60Hz
HUHAADS25	685360036595	Power Disconnect Switch (3-Pole)	30A @ 600VAC, Res.
HUHAADS60	685360036601	Power Disconnect Switch (3-Pole)	80A @ 600VAC, Res.

NOTE: Any field installed options assembled in the factory require added surcharge. See price book for charges. MPDS60 disconnect switch is not suitable for field installation on 7.5kw and 10kw unit heaters. Visit website or contact your local representative for compatibility details.

Diffusers for Vertical Mounting:

No Diffuser:

No diffuser needed where a straight downflow air pattern is required. For maximum air throw, remove louvers. Any of three diffusers can be added to basic heater.

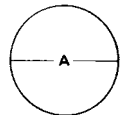
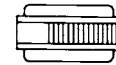

Louver Diffuser:

Permits directional (straight line) air flow as in air curtain application over doorways. Rectangular coverage, Louvers can be turned in either direction.

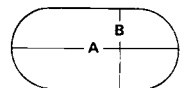
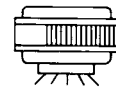

NOTE: Visit website or contact your local representative for additional details

Suggested Controls



Now compatible with SmartSeries Plus when used with 24VAC control transformer!

NEW PRODUCT!

HUHAA-PRO Series Bundled Unit Heater

Pre-bundled package streamlines ordering. **Eliminates the need for custom configuration** by including all of the most commonly-ordered accessories.

HUHAA-PRO+ Series Bundled Unit Heater

Upgrade from the HUHAA-PRO with the addition of the **SmartSeries® Plus thermostat** and **B10 mounting bracket**



Free One-Hour CEU Courses Earn Your Credits from Home



Scan or click the QR code to take the courses and earn credit now!

HUHAA-PRO SERIES

Bundled Unit Heater

UNIT HEATERS

Comfort, Convenience, and Connected

The HUHAA-PRO Series Unit Heaters are the same great HUHAA unit heater you rely on every day and now with bundle options to customize your comfort. Bundled options include our most popular safety and control accessories designed to make heating your space effortless and ordering a breeze.

HUHAA SERIES

Basic Model



When you need heat fast, this heater goes right to work.

Works with existing remote-mounted thermostats.

Ideal for replacement projects when no additional accessories are needed.

HUHAA-PRO SERIES

Pro Bundle



The Pro Bundle includes the HUHAA Series Unit Heater with our most popular accessories.

Bundling accessories saves time and money.

Includes 24VAC Transformer for easy low voltage thermostat connection and future proofing.

Includes disconnect switch for safe and easy maintenance or repair.

Includes built-in single state thermostat for easy operation right out of the box.

HUHAA-PRO+ SERIES

Pro+ Bundle



Take your heat to the next level with the HUHAA-Pro+ Series bundled with all the accessories you need.

Includes SmartSeries® Plus thermostat and B10 mounting bracket.

Connects to BACnet MS/TP Building Management Systems for easy control and monitoring.

Digital touchscreen with 7-day programmability for easy scheduling when BMS is not available.

Built-in cooling mode, keypad lock and programmable vacation mode with no extra components.



Scan the QR code to access additional specs and features.

**NEW
PRODUCT!**

HUHAA-PRO SERIES

Bundled Unit Heater

UNIT HEATERS

Models & Specifications:

ITEM INFORMATION			ELECTRICAL DATA					AIR DELIVERY DATA FAN MOTOR DATA	
CATALOG NO.	UPC	VOLTS	PHASE	KW	AMPS	CONTROL VOLT	CFM	SHIP WT:	
◆ HUHAA320-PRO	685360174297	208	1	3	14.5	24	350	27 lbs	
◆ HUHAA320-PRO-SSP	685360174747	208	1	3	14.5	24	350	27 lbs	
◆ HUHAA520-PRO	685360173993	208	1-3	5	24	24	350	27 lbs	
◆ HUHAA520-PRO-SSP	685360174792	208	1-3	5	24	24	350	27 lbs	
◆ HUHAA720-PRO	685360174020	208	1-3	7.5	36	24	650	38 lbs	
◆ HUHAA720-PRO-SSP	685360174808	208	1-3	7.5	36	24	650	38 lbs	
◆ HUHAA1020-PRO	685360173931	208	1-3	10	48	24	650	38 lbs	
◆ HUHAA1020-PRO-SSP	685360174594	208	1-3	10	48	24	650	38 lbs	
◆ HUHAA324-PRO	685360173979	208/240	1-3	3	11.0/12.5	24	350	27 lbs	
◆ HUHAA324-PRO-SSP	685360174754	208/240	1-3	3	11.0/12.5	24	350	27 lbs	
◆ HUHAA524-PRO	685360174006	208/240	1-3	5	18.0/21.0	24	350	27 lbs	
◆ HUHAA524-PRO-SS	685360174785	208/240	1-3	5	18.0/21.0	24	350	27 lbs	
◆ HUHAA724-PRO	685360174037	208/240	1-3	7.5	27.0/31.3	24	650	38 lbs	
◆ HUHAA724-PRO-SSP	685360174815	208/240	3	7.5	27.0/31.3	24	650	38 lbs	
◆ HUHAA1024-PRO	685360173955	208/240	3	10	36.0/42.0	24	650	38 lbs	
◆ HUHAA1024-PRO-SSP	685360174723	208/240	3	10	36.0/42.0	24	650	38 lbs	
◆ HUHAA348-PRO	685360173986	480	3	3	3.6	24	350	27 lbs	
◆ HUHAA348-PRO-SSP	685360174761	480	3	3	3.6	24	350	27 lbs	
◆ HUHAA548-PRO	685360174013	480	3	5	6	24	350	27 lbs	
◆ HUHAA548-PRO-SSP	685360174778	480	3	5	6	24	350	27 lbs	
◆ HUHAA748-PRO	685360174044	480	3	7.5	9	24	650	38 lbs	
◆ HUHAA748-PRO-SSP	685360174822	480	1-3	7.5	9	24	650	38 lbs	
◆ HUHAA1048-PRO	685360173948	480	1	10	12	24	650	38 lbs	
◆ HUHAA1048-PRO-SSP	685360174730	480	1	10	12	24	650	38 lbs	

SKU Legend: ◆ = Popular Products; ● = Extended Offering (Contact your local Marley Sales Representative for typically associated lead times)

*Shipping weight includes mounting bracket

NOTE: All standard units are supplied with a low voltage control transformer and contactor (24V) except MUH03 and MUH05, 208V, 240V and 277V models. Low voltage control on these units is available on Made to Order (Contact your local Marley Sales Representative for typically associated lead times). All units are also available on special order for 120V control; internal with transformer or external without transformer. On dual-voltage units CFM, FPM, & RPM ratings are listed at higher voltage operation. On dual-phase units maximum amp draw is listed for respective voltage. 25 thru 50 KW models having two-speed motors and dual CFM ratings are listed in Full Line Catalog, 5A. Standard; 5B. *Must use two-stage Thermostat on 3Ø operation.

On dual-voltage units CFM, FPM, & RPM ratings are listed at higher voltage operation. On dual-phase units maximum amp draw is listed for respective voltage.

HHUHAA-Pro Bundled Accessories:

ACCESSORY	DESCRIPTION
24VAC Transformer	Takes incoming line voltage and drops it to low voltage (24VAC) to be used with low voltage thermostats.
Disconnect Switch	A three pole non-fused disconnect switch disconnects power to the heater. Design prevents entry into the control compartment until disconnect switch is turned to the OFF position.
Built-In Single Stage Thermostat	Built-in single stage thermostat with adjustable knob to have heater run until demand is satisfied.

HUHAA-Pro+ Bundled Accessories:

ACCESSORY	DESCRIPTION
24VAC Transformer	Takes incoming line voltage and drops it to low voltage (24VAC) to be used with low voltage thermostats.
Disconnect Switch	A three pole non-fused disconnect switch disconnects power to the heater. Design prevents entry into the control compartment until disconnect switch is turned to the OFF position.
Built-In Single Stage Thermostat	Built-in single stage thermostat with adjustable knob to have heater run until demand is satisfied.
SmartSeries® Plus thermostat	Remote Mount two stage thermostat runs 2/3 elements on stage 1 and full heat for stage 2. Fan cycles on high speed only. Comes with BACnet BMS compatibility, scheduling, cooling mode (Fan-Only), and keypad lock.
B10 mounting bracket	Used to easily mount the unit heater to the wall

HUH SERIES

Industrial Unit Heater

UNIT HEATERS



This heavy-duty heater provides a **long-term comfort solution** wherever you need to warm up — garages, workshops, basements, even outdoor spaces. Aim heat anywhere with adjustable louvers and **flexible mounting options** for both horizontal and vertical applications.

Key Features:

Long-lasting Comfort

If you've got a constantly cold and drafty garage, basement or workshop, this heavy-duty heater provides a worthy long-term solution. Its powerful output means you can even use it to warm outdoor areas.

Conforms to Your Power System

Whether you need 208 or 240 volts, this heater is fully compatible with your electrical system.

Control Your Output

Multiple wattages enable you to set your heat output level to deliver as much warmth as you need.

Directional Heating

This model features adjustable louvers, so you can aim your heat directly toward your desired area and redirect it whenever your heating needs change.

Install Anywhere

This heater easily makes room for itself. With an optional mounting bracket, this unit can be easily installed vertically or horizontally in any room.



Scan the QR code to access additional specs and features.

Technical Specifications:

Temp Range: 45°–90°F

CFM: 270–1800

Ideal Spaces:

- Factories
- Garages
- Stockrooms
- Stores
- Maintenance Rooms
- Warehouses
- Service Stations
- Workshops
- Stairwells

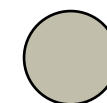

Beige

HUH SERIES

Industrial Unit Heater

UNIT HEATERS

Models & Specifications:

ITEM INFORMATION			ELECTRICAL DATA						
CATALOG NO.	UPC	KW	BTU/HR.	VOLTAGE	PHASE	MAX AMPERAGE 3 PHASE	CFM	WEIGHT	
◆ HUH520SA	685360038612	5	17	208	1-3	12.5	270	26 lbs	
◆ HUH548SA	685360038933	5	17	480	1-3	6	270	31 lbs	
◆ HUH724SA	685360039121	7.5	25.6	240	1-3	18.1	270	27 lbs	
◆ HUH748SA	685360039268	7.5	25.6	480	1-3	9	270	31 lbs	
◆ HUH1024M	685360037134	10	34.1	240	1-3	25.7	500	62 lbs	
◆ HUH1048M	685360037233	10	34.1	480	1-3	12.8	500	72 lbs	
◆ HUH1524M	685360037448	15	51.2	240	1-3	37.7	750	68 lbs	
◆ HUH1548M	685360037547	15	51.2	480	1-3	18.8	750	78 lbs	
◆ HUH2048M	685360037769	20	68.2	480	1-3	24.8	1000	78 lbs	
◆ HUH3048L	685360038186	30	102.2	480	3	36.9	1800	142 lbs	
● HUH524SA	685360038711	5	17	240	1-3	13.8	270	26 lbs	
● HUH720SA	685360039077	7.5	25.6	208	1-3	21.3	270	27 lbs	
● HUH2548L	685360038063	25	85.2	480	3	31.1	1300	136 lbs	
● HUH560SA	685360039039	5	17	600	3	4.8	270	31 lbs	
● HUH760SA	685360039374	7.5	25.6	600	3	7.2	270	31 lbs	
● HUH1060M	685360037295	10	34.1	600	3	9.6	500	72 lbs	
● HUH1560M	685360037653	15	51.2	600	3	14.5	750	80 lbs	
● HUH2060M	685360037813	20	68.2	600	3	19.3	1000	80 lbs	
● HUH2560L	685360038131	25	85.2	600	3	24	1300	142 lbs	
● HUH3060L	685360038223	30	102.2	600	3	28.9	1800	142 lbs	

SKU Legend: ◆ = Popular Products; ● = Extended Offering (Contact your local Marley Sales Representative for typically associated lead times)

Optional Accessories:

CATALOG NO.	UPC	DESCRIPTION	SHIP WT.
CWB1A	685360018201	Combination wall/ceiling bracket for 5KW thru 15KW units	4 lbs
CWB2A	685360152400	Same as above but for 20KW thru 50KW units	14 lbs
UHTA1	685360152431	Single-Pole Thermostat kit 60-120°F temp. range for field installation in all units except 3 PH IUH520 and IUH524, 3 PH	1 lbs
DS30*	685360019956	3-pole power disconnect switch kit for field installation on all horizontal unit heaters rated 24 amps or less.	1 lbs
DS63*	685360019963	3-pole power disconnect switch kit for field installation on all horizontal unit heaters 10KW and above rated 24 to 50 amps.	1 lbs
SW	685360036724	Summer-Winter Fan Switch Kit. Field installed. Provides summer fan operation.	1 lbs

Dimensions and Clearances:

KW Size	A	B	C	D	E	F	G	H	I	J
5-7.5	14"	12 ½"	12 ¾"	5 ½"	13"	1 ¾"	1 ¾"	1 ½"	(2) ½", ¾"	½"
10-20	18"	18"	17 ½"	9 15/32"	*	2"	2 ½"	2 ¼"	(2) ¾", 1"	(3) 1", 1¼", 1½"
25-30	26"	24"	23 ⅛"	9 15/32"	20"	2"	2 ¾"	2 ¼"	(2) 1", 1½"	(3) 1", 1½", 2"

*13 in. for 10-15 kW units; 16 in. for 20 kW unit. 5 kW and 7.5 kW can be used in horizontal vertical position. Heaters come equipped with ceiling mounting bracket for horizontal or vertical flow mounting or any position between.

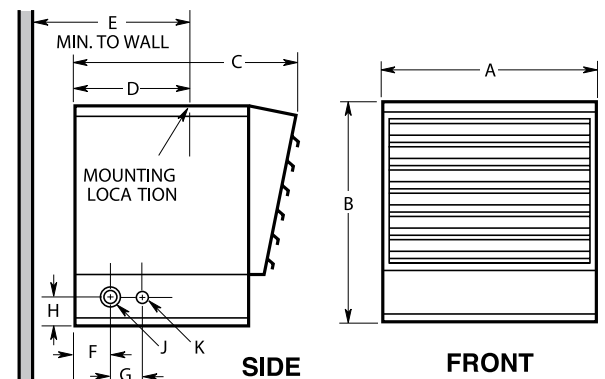

HUHTA/ST SERIES

Bundled Horizontal/Downflow Unit Heater

UNIT HEATERS

Limited space? We've got your customized comfort covered.

Choose the HUH Series Horizontal/Downflow Unit Heater for basic heating or the HUHTA/ST Bundle with an included mounting bracket and built-in thermostat for one-stop-shopping. Both have adjustable louvers and flexible mounting options that enable you to take aim at the cold. Best of all, both heaters will keep your coldest spots warm and comfortable for years to come.

HUH SERIES

Basic Model



Unit comes with adjustable louvers to control airflow and put the heat where it is needed

Robust elements are designed to keep your space comfortable for the long haul

Variety of sizes and accessories to meet the demands of any given space

HUHTA/ST SERIES

Bundle



Includes the great features of the HUH plus mounting bracket and built-in thermostat

Ceiling/Wall mounting bracket gives you ease and flexibility for installation

The built-in thermostat gives you control to keep the space at the perfect temperature

All the necessary features in one box make this heater the bestselling unit heater



Scan the QR code to access additional specs and features.

HUHTA/ST SERIES

Bundled Horizontal/Downflow Unit Heater

UNIT HEATERS

Models & Specifications:

ITEM INFORMATION			ELECTRICAL DATA				SHIP WT.
CATALOG NO.	UPC	VOLTS	WATTS	BTU/HR	HEATER AMPS		
◆ HUH524TA	685360038803	208	1874	6396	9	24 lbs	
			2500	8553	12		
			3123	10659	15		
			3750	12799	18		
		240	2500	8533	10.4		
			3332	11365	13.9		
			4165	14215	17.4		
			5000	17065	20.9		
◆ HUH724ST	685360148700	208	2812	9598	13.5	27 lbs	
			3750	12799	18		
			4685	15990	22.5		
			5625	19198	27.1		
		240	3750	12799	15.6		
			5000	17065	20.8		
			6250	21331	26		
			7500	25598	31.3		

SKU Legend: ◆ = Popular Products; ● = Extended Offering (Contact your local Marley Sales Representative for typically associated lead times)

NOTE: Disconnect switch (DS30) option available for heaters 24 amps or lower. Optional CWBIA combination wall/ceiling bracket available.

Dimensions and Clearances:

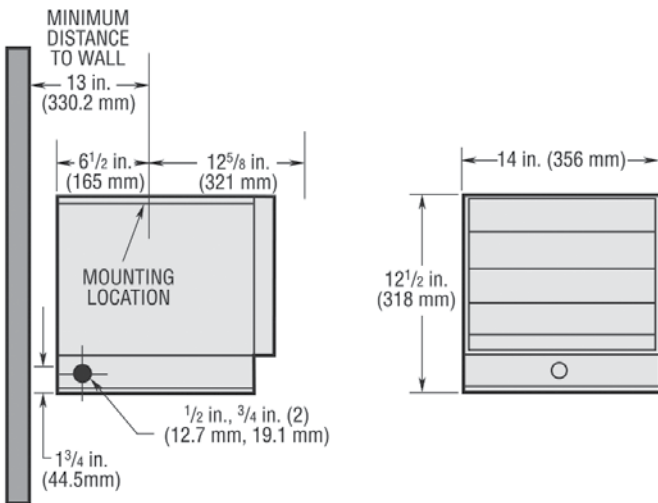

PH5HWAC SERIES

Unit Heater

UNIT HEATERS



For primary or spot heating in factories, warehouses, garages, and other **open areas**, these unit heaters excel. With a **variety of mounting and airflow options**, you can create just the right comfort level for your space.

Dimensions and Clearances:

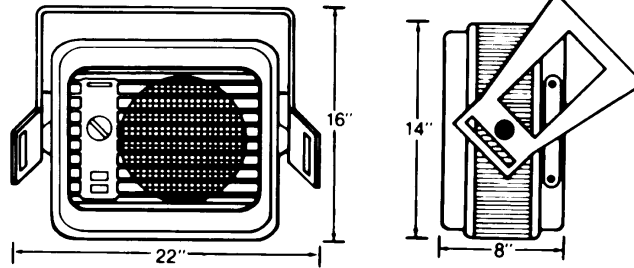

Key Features:

Angle Your Airflow

These unit heaters are designed for maximum flexibility. Install them to create vertical or horizontal airflow patterns or direct them at any angle you desire.

Space Saving Solution

With an included mounting bracket, you can install these unit heaters on a wall or ceiling to make best use of your available installation space and to cover the widest area possible.

Temperature Control

These unit heaters feature a built-in bimetal thermostat, plus a heat selector switch that allows you to select the right wattage for your space.

Fan Only Operation

When you don't need extra heat, set this unit heater to fan only mode for extra airflow and cooling.

Models & Specifications:

ITEM INFORMATION		ELECTRICAL DATA				SHIP WT.
CATALOG NO.	UPC	VOLTS	WATTS	BTU/HR	AMPS	
◆ PH5HWAC	685360150710	240	5000/3333	17060/11372	21.0/14.0	28 lbs
		208	3750/2500	12795/8530	18.0/12.0	

SKU Legend: ◆ = Popular Products; ● = Extended Offering (Contact your local Marley Sales Representative for typically associated lead times)

Optional Accessories:

CATALOG NO.	UPC	DESCRIPTION
PHCSIB	685360150703	Cord & Plug Assembly (Optional)



Scan the QR code to access additional specs and features.

Technical Specifications:

Temp Range: 40°-90°F
CFM: 210

Ideal Spaces:

Factories
Garages
Schools
Shipping Docks
Warehouses

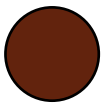

Bronze

GH48R SERIES

Digital Remote-Controlled Garage Heater

UNIT HEATERS



Remote control requires (2) AAA batteries. Not included.

Turn your cold garage into a **year-round usable living space** with this robust, reliable fan-forced garage heater. The included bracket makes for easy installation on the wall or ceiling of your garage, workshop or stockroom. The included remote control and timer feature make it simple to set the right temperature and to make sure the heater is **only running when you need it**.

Key Features:

Warm Up Cold Spaces

This powerful heater can go beyond the garage — install it in storage areas, stockrooms, workshops, or any other space you need primary or supplemental heat.

Long-Lasting Performance

The unit's built-in fan delay is designed to prolong the life of your heating element.

Total Control

A 9-hour timer with automatic shutoff brings the heat when you need it, while the integrated thermostat ranges from 45° to 99° F to handle your specific garage conditions.

Easy Viewing

The easy-to-read digital LED interface lets you tell at a glance what the current temperature level is.

Stay in Control

The included remote allows you to set your perfect temperature even from across the room.

Technical Specifications:

Temp Range: 45°–99°F
CFM: 160

Ideal Spaces:

- Garages
- Workshops
- Stockrooms
- Mechanical Spaces



Black

Models & Specifications:

ITEM INFORMATION		ELECTRICAL DATA				SHIP WT.
CATALOG NO.	UPC	VOLTS	WATTS	AMPS	BTU/HR	
◆ GH48R	685360165691	240	2400/4800	10/20	8189/16,378	13 lbs
		208	1800/3600	8.6/17.3	6142/12,284	

SKU Legend: ◆ = Popular Products; ● = Extended Offering (Contact your local Marley Sales Representative for typically associated lead times)
Includes mounting bracket for wall or ceiling installation



Scan the QR code to access additional specs and features.

NEW PRODUCT!

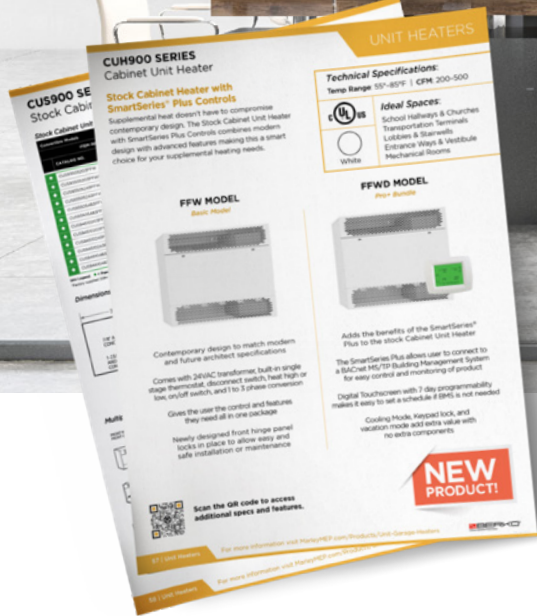

Eliminates the need for custom configuration by including all of the most commonly-ordered features.

THE MARLEY ENGINEERED PRODUCTS BIM LIBRARY
Bringing you Revit Families from the Best in the Industry



Learn more at MarleyMEP.com/Bim-Revit-Library

CUHS900 SERIES

Cabinet Unit Heater

UNIT HEATERS

Stock Cabinet Heater with SmartSeries® Plus Controls

Supplemental heat doesn't have to compromise contemporary design. The Stock Cabinet Unit Heater with SmartSeries Plus Controls combines modern design with advanced features making this a smart choice for your supplemental heating needs.

Technical Specifications:

Temp Range: 55°-85°F | CFM: 200-500



Ideal Spaces:

School Hallways & Churches
 Transportation Terminals
 Lobbies & Stairwells
 Entrance Ways & Vestibule
 Mechanical Rooms

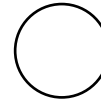

White

FFW MODEL

Basic Model

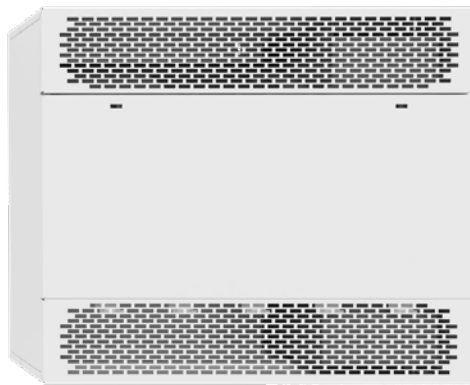

Contemporary design to match modern and future architect specifications

Comes with 24VAC transformer, built-in single stage thermostat, disconnect switch, heat high or low, on/off switch, and 1 to 3 phase conversion

Gives the user the control and features they need all in one package

Newly designed front hinge panel locks in place to allow easy and safe installation or maintenance

FFWD MODEL

Pro+ Bundle

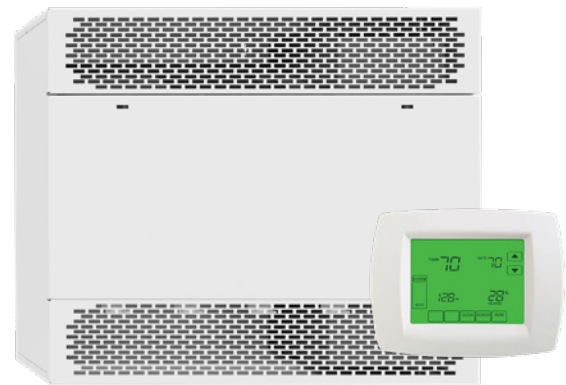

Adds the benefits of the SmartSeries® Plus to the stock Cabinet Unit Heater

The SmartSeries Plus allows user to connect to a BACnet MS/TP Building Management System for easy control and monitoring of product

Digital Touchscreen with 7 day programmability makes it easy to set a schedule if BMS is not needed

Cooling Mode, Keypad lock, and vacation mode add extra value with no extra components



Scan the QR code to access additional specs and features.

**NEW
PRODUCT!**

CUHS900 SERIES

Cabinet Unit Heater

UNIT HEATERS

Stock Cabinet Unit Heaters: Models & Specifications:

Convertible Models									
ITEM INFORMATION								DIMENSIONAL DATA	
CATALOG NO.	UPC	CFM		VOLTS/PH.	AMPS	WATTAGE (KW)	DIM	SHIP WT.	
		HI	LO						
◆ CUHS93505203FFW	685360174174	250	200	208V/3Ø	14	5	35" W 26 3/8" H 9 7/8" D	120 lbs	
◆ CUHS93505203FFWD	685360174181	250	200	208V/3Ø	14	5		120 lbs	
◆ CUHS93505243FFW	685360174198	250	200	240V/3Ø	12	5		120 lbs	
◆ CUHS93505243FFWD	685360174204	250	200	240V/3Ø	12	5		120 lbs	
◆ CUHS93505483FFW	685360174211	250	200	480V/3Ø	6	5		120 lbs	
◆ CUHS93505483FFWD	685360174228	250	200	480V/3Ø	6	5		120 lbs	
◆ CUHS94510203FFW	685360174235	500	400	208V/3Ø	34	10	45" W 26 3/8" H 9 7/8" D	120 lbs	
◆ CUHS94510203FFWD	685360174242	500	400	208V/3Ø	34	10		120 lbs	
◆ CUHS94510243FFW	685360174259	500	400	240V/3Ø	15	10		120 lbs	
◆ CUHS94510243FFWD	685360174266	500	400	240V/3Ø	15	10		120 lbs	
◆ CUHS94510483FFW	685360174273	500	400	480V/3Ø	12	10		120 lbs	
◆ CUHS94510483FFWD	685360174280	500	400	480V/3Ø	12	10		120 lbs	

SKU Legend: ◆ = Popular Products; ● = Extended Offering (Contact your local Marley Sales Representative for typically associated lead times)

*Factory supplied 208V or 240V, 3PH field convertible to 1PH, 480V 3 PH convertible to 277V 1PH, 600V 3 PH convertible to 347V 1PH. **Amps shown are 3 PH, High heat operation. Field Convertible to 1PH.

Dimensions and Clearances:

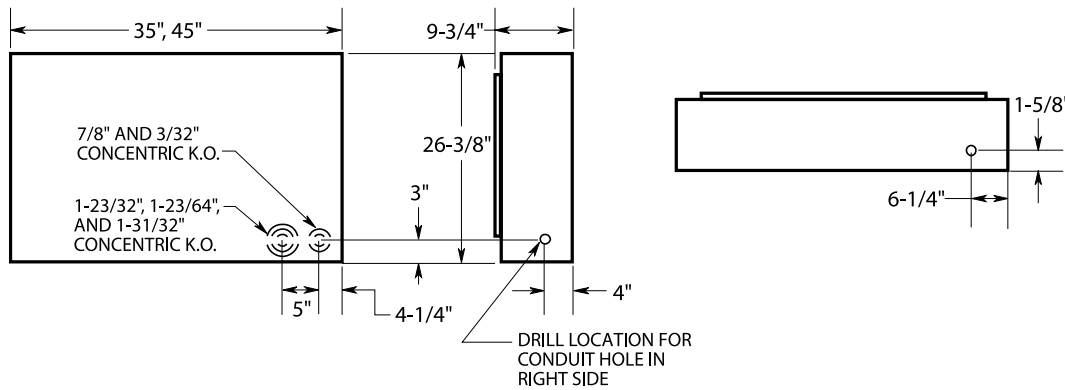

Multiple Air Flow Combinations

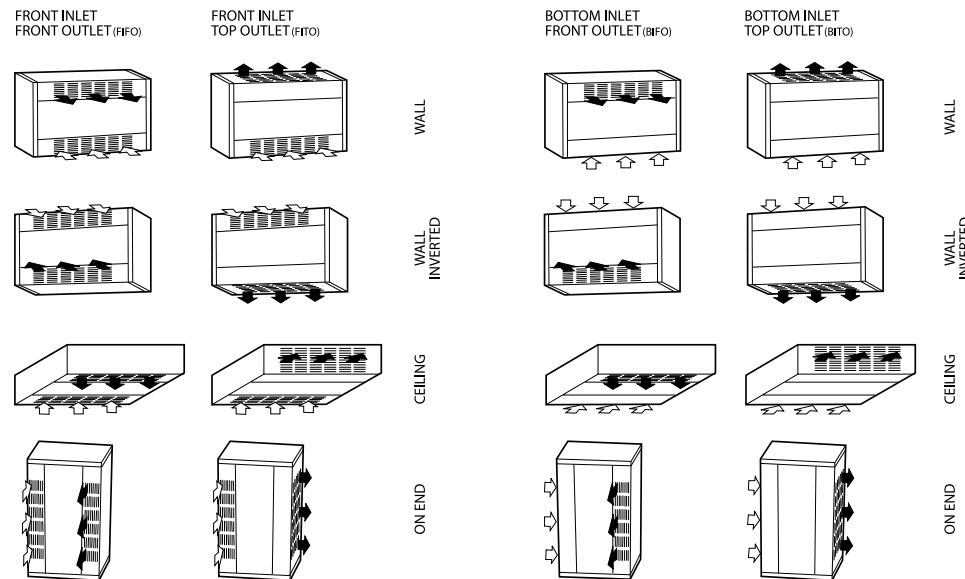

Suggested Controls



Now compatible with SmartSeries® Plus when used with 24VAC control transformer!

CUHS900 SERIES

Cabinet Unit Heater

UNIT HEATERS

Optional Accessories:

CATALOG NO.	DESCRIPTION	COMPATIBLE WITH	FUNCTION	SHIP WT.
CUH935RTK	Ceiling or Wall Recess Trim Kit	CUH935	Provides a neat finish to semi-recessed or full recessed application.	3 lbs
CUH945RTK		CUH945		4 lbs
CUH935BK	Floor/Toe-Space Base Kit	CUH935	16 gauge, muted black base is recessed from the heater front and sides to provide an attractive and practical floor mounting application.	9 lbs
CUH945BK		CUH945		10 lbs
CUH935WF	Permanent, Reusable Washable Filter	CUH935	Replaces standard filter Washable filter can be cleaned and replaced.	4 lbs
CUH945WF		CUH945		6 lbs

Standard Accessories - FFW Models:

ACCESSORY	DESCRIPTION
Built-In Thermostat	Built-in single stage thermostat with adjustable knob to have heater run until demand is satisfied.
Manual Reset	Manual Reset over temperature cutout wired into control circuit. Supplied in addition to auto-reset cutout.
Dead Front Disconnect Switch	A three pole non-fused disconnect switch disconnects power to the heater. Design prevents entry into the control compartment until disconnect switch is turned to the OFF position.
Fan/Heat High/Low Switch	Allows user to select whether the heater will run in low mode (2/3 output) or high (full output).
ON/OFF Switch	Allows the user to turn off the unit so it will not run during warm months or when not needed.

Standard Accessories - FFWD Models:

ACCESSORY	DESCRIPTION
Smartseries® Plus	Built-in two stage thermostat runs 2/3 elements on stage 1 and full heat for stage 2. Fan cycles on high speed only. Comes with BACnet BMS compatibility, scheduling, cooling mode (Fan-Only), and keypad lock.
Manual Reset	Manual Reset over temperature cutout wired into control circuit. Supplied in addition to auto-reset cutout.
Dead Front Disconnect Switch	A three pole non-fused disconnect switch disconnects power to the heater. Design prevents entry into the control compartment until disconnect switch is turned to the OFF position.

BPH SERIES

Plenum-Rated Unit Heater

Concealed Space Use – Zero Clearance

UNIT HEATERS



This zero-clearance, plenum-rated unit heater fits unobtrusively into **unique spaces** where you need freeze protection or extra comfort for occupants. It even connects to **existing ductwork**, making it easy to integrate with your building's environmental system.

Key Features:

Concealed Comfort

Address the warming needs of plenum spaces, drop ceilings and other concealed areas with this targeted unit heater. Its zero clearance design allows it to fit into spaces other heating solutions can't reach.

For Any Heating Job

These unit heaters deliver a wide range of output levels, and select models offer a two-speed fan for additional power and specific control of your output temperature.

Plenum-Rated Protection

Install this unit heater anywhere you have sensitive pipes, conduits or other equipment that might be vulnerable to freezing. It provides reliable output to keep your sensitive infrastructure running smoothly.

Dimensions and Clearances:

Small Cabinet

Large Cabinet

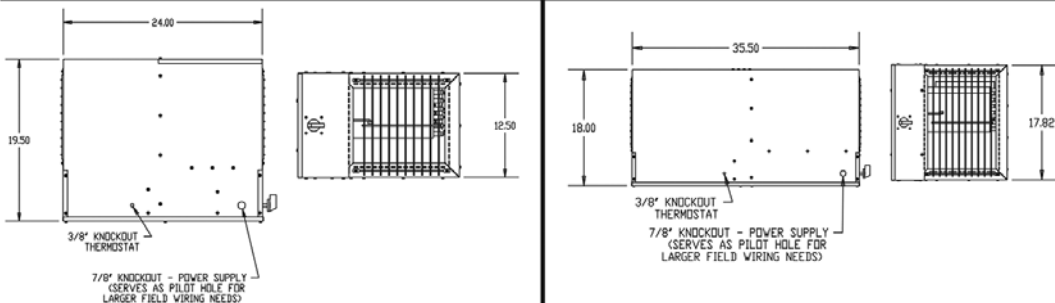

Technical Specifications:

Temp Range: 40°-90°F

CFM: 350-1000

Ideal Spaces:

- Concealed Areas
- Concession Stands
- Bathrooms
- Plenum Areas
- Entrance Ways

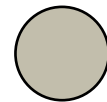

Beige



Scan the QR code to access additional specs and features.

Models & Specifications:

ITEM INFORMATION			ELECTRICAL DATA				LOW SPEED		HIGH SPEED		DIMENSIONAL DATA	
CATALOG NO.	UPC	PHASE	KW	VOLTS	AMPS	CFM	TEMP RISE	CFM	TEMP RISE	SHIP WT.	DIMENSIONS	
◆ BPH138124	685360149936	1	3	208	15.32	350	27°F	400	24°F	57	12.5" x 19.5" x 24"	
◆ BPH138324	685360149950	3	3	208	9.23	350	27°F	400	24°F	57	12.5" x 19.5" x 24"	
◆ BPH134324	685360150130	3	3	480	4.11	-	-	400	24°F	57	12.5" x 19.5" x 24"	
◆ BPH158124	685360150055	1	5	208	24.94	350	45°F	400	39°F	57	12.5" x 19.5" x 24"	
◆ BPH158324	685360150079	3	5	208	14.78	350	45°F	400	39°F	57	12.5" x 19.5" x 24"	
● BPH132124	685360150093	1	3	240	13.4	350	27°F	400	24°F	57	12.5" x 19.5" x 24"	
● BPH137124	685360150154	1	3	277	11.63	350	27°F	400	24°F	57	12.5" x 19.5" x 24"	
● BPH132324	685360150116	3	3	240	8.12	350	27°F	400	24°F	57	12.5" x 19.5" x 24"	
● BPH152124	685360149974	1	5	240	21.73	350	45°F	400	39°F	57	12.5" x 19.5" x 24"	
● BPH157124	685360150031	1	5	277	18.85	350	45°F	400	39°F	57	12.5" x 19.5" x 24"	
● BPH152324	685360149998	3	5	240	12.93	350	45°F	400	39°F	57	12.5" x 19.5" x 24"	
● BPH154324	685360150017	3	5	480	6.51	-	-	400	39°F	57	12.5" x 19.5" x 24"	
● BPH158124L	685360151052	1	5	208	24.94	850	20°F	1000	16°F	69	18" x 18" x 35.5"	
● BPH152124L	685360150970	1	5	240	21.73	850	20°F	1000	16°F	69	18" x 18" x 35.5"	
● BPH157124L	685360151038	1	5	277	18.85	850	20°F	1000	16°F	69	18" x 18" x 35.5"	
● BPH158324L	685360151076	3	5	208	14.78	850	20°F	1000	16°F	69	18" x 18" x 35.5"	
● BPH152324L	685360150994	3	5	240	12.93	850	20°F	1000	16°F	69	18" x 18" x 35.5"	
● BPH154324L	685360151014	3	5	480	6.51	-	-	1000	16°F	69	18" x 18" x 35.5"	
● BPH1758124	685360150253	1	7.5	208	38.12	850	28°F	1000	24°F	69	18" x 18" x 35.5"	
● BPH1752124	685360150178	1	7.5	240	33.31	850	28°F	1000	24°F	69	18" x 18" x 35.5"	
● BPH1757124	685360150239	1	7.5	277	28.91	850	28°F	1000	24°F	69	18" x 18" x 35.5"	
● BPH1758324	685360150277	3	7.5	208	22.88	850	28°F	1000	24°F	69	18" x 18" x 35.5"	
● BPH1752324	685360150192	3	7.5	240	20.1	850	28°F	1000	24°F	69	18" x 18" x 35.5"	
● BPH1754324	685360150215	3	7.5	480	10.16	-	-	1000	24°F	69	18" x 18" x 35.5"	
● BPH1102124	685360150291	1	10	240	43.73	850	37°F	1000	31°F	69	18" x 18" x 35.5"	
● BPH1107124	685360150352	1	10	277	37.93	850	37°F	1000	31°F	69	18" x 18" x 35.5"	
● BPH2102124	685360151090	1	10	240	43.73	850	37°F/20°F	1000	31°F/16°F	69	18" x 18" x 35.5"	
● BPH2107124	685360151151	1	10	277	37.93	850	37°F/20°F	1000	31°F/16°F	69	18" x 18" x 35.5"	
● BPH1108324	685360150376	3	10	208	29.82	850	37°F	1000	31°F	69	18" x 18" x 35.5"	
● BPH1102324	685360150314	3	10	240	26.12	850	37°F	1000	31°F	69	18" x 18" x 35.5"	
● BPH1104324	685360150338	3	10	480	13.17	-	-	1000	31°F	69	18" x 18" x 35.5"	
● BPH2108324	685360151175	3	10	208	29.82	850	37°F/20°F	1000	31°F/16°F	69	18" x 18" x 35.5"	
● BPH2102324	685360151113	3	10	240	26.12	850	37°F/20°F	1000	31°F/16°F	69	18" x 18" x 35.5"	
● BPH2104324	685360151137	3	10	480	13.17	-	-	1000	31°F/16°F	69	18" x 18" x 35.5"	
● BPH158324	685360150437	3	15	208	43.9	850	56°F	1000	47°F	69	18" x 18" x 35.5"	
● BPH152324	685360150390	3	15	240	38.14	850	56°F	1000	47°F	69	18" x 18" x 35.5"	
● BPH154324	685360150413	3	15	480	19.18	-	-	1000	47°F	69	18" x 18" x 35.5"	
● BPH2152324	685360151199	3	15	240	38.14	850	56°F/28°F	1000	47°F/24°F	69	18" x 18" x 35.5"	
● BPH2154324	685360151212	3	15	480	19.18	-	-	1000	47°F/24°F	69	18" x 18" x 35.5"	

SKU Legend: ◆ = Popular Products; ● = Extended Offering (Contact your local Marley Sales Representative for typically associated lead times)

NOTE: Total Amps including Resistive and Inductive loads.

**Low and High speed fan operation is determined during installation of thermostat set up † Tested @0.2" S.P. ** Low speed fan operation not available on 480V models.

Optional Accessories:

CATALOG NO.	DESCRIPTION	OPENING	DIMENSIONS (W x H x D)	SHIP WT.
FRST10	Throw away filter, including rack for 3 & 5KW unit.	Inlet side	15" x 20" x 4.5"	4 lbs
FRWS15	Reusable filter, including rack for 3 & 5KW unit.	Inlet side	15" x 20" x 4.5"	4 lbs
FRLT20	Throw away filter, including rack for 7.5 to 15KW unit.	Inlet side	15" x 20" x 4.5"	5 lbs
FRWL25	Reusable filter, including rack for 7.5 to 15KW unit.	Inlet side	15" x 20" x 4.5"	5 lbs
LKS10	Adjustable louver kit for 3 & 5KW units	Outlet side	15" x 20" x 4.5"	5.5 lbs
LKL15	Adjustable louver kit for 7.5 to 15KW units	Outlet side	15" x 20" x 4.5"	6 lbs
AES10	Aluminum Wall Louver kit for inside heated room for 3 & 5KW units	Inside room	Rough in: 13 1/8" x 13 3/4"	3 lbs
AESL15	Aluminum Wall Louver kit for inside heated room for 7.5 to 15KW units	Inside room	Rough in: 15 3/4" x 15 3/4"	3.5 lbs
TH5220D1003	Electronic Digital 2-Stage 24V Thermostat	Inside room	5 3/4" x 3 3/4" x 1 1/2"	4 lbs
PRHT1	Single Pole Field installed thermostat. Range 40° to 85°F	At heater	25A @ 240V resistive; 22A @ 277V	3 lbs

PHFP25 SERIES

Plenum-Rated Unit Heater

Concealed Space Use – Zero Clearance

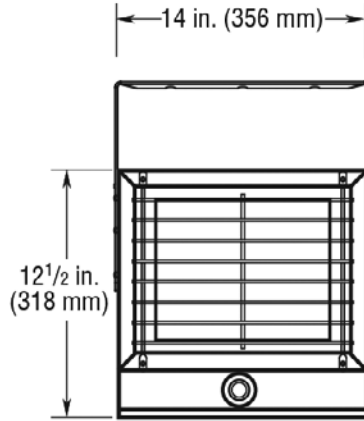

UNIT HEATERS

Concealed spaces can be tricky to heat. Choose plenum-rated unit heaters for just that purpose. They provide warmth and **freeze protection** in areas that are otherwise difficult to reach with your main heating solution.

Key Features:

Plenum-Rated Protection

Install this unit heater anywhere you have sensitive pipes, conduits or other equipment that might be vulnerable to freezing. It provides reliable output to keep your sensitive infrastructure running smoothly.

Concealed Comfort

Address the warming needs of plenum spaces, drop ceilings and other concealed areas with this targeted unit heater. Its zero clearance design allows it to fit into spaces other heating solutions can't reach.

Warm Air Only

This unit heater features a fan delay, allowing its heating element to warm up before it begins blowing air into the space.

One Connection

This unit heater is equipped for single-point field wiring, so you can easily install it, and easily disconnect from power when it's time to service it.

Technical Specifications:

Temp Range: 40°–90°F
CFM: 150

Ideal Spaces:

Between Finished Ceiling & Drop Ceiling

Plenum Areas
Freeze Protection



Models & Specifications:

ITEM INFORMATION			ELECTRICAL DATA								
CATALOG NO.	UPC		VOLTS	kW	AMPS	PHASE	HZ	BTU/HR	FPM	RISE	SHIP WT.
◆ PHFP25	685360149547		240	2.5	10.7	1	60	8530	1880	60° F	26 lbs
			208	1.9	9.42		60	6398		46° F	

SKU Legend: ◆ = Popular Products; ● = Extended Offering (Contact your local Marley Sales Representative for typically associated lead times)

Optional Accessories:

CATALOG NO.	UPC	DESCRIPTION	SHIP WT.
AFL240	685360153476	Thermal Limit Alarm	1 lbs



Scan the QR code to access additional specs and features.

Baseboard heaters provide simplistic comfort

The versatility of baseboard heaters make them an excellent choice for a variety of residential and commercial applications, where quiet, soft heat is desired.

EVERY-DAY VALUE

*Simple, Low Cost
Instant Heat
UL Listed for Floor & Wall Mount*



2500 Series Electric Baseboards

PROFESSIONAL VALUE

*Good Feature Set
Heavy Gauge Construction*



BKOC Commercial Baseboards

AESTHETIC & COMFORT VALUE

*Maximum Comfort
Welded Safety Grill
Gentle & Sustained Heat Transfer*



HBB Hydronic Baseboards

COST AND SIMPLICITY

COMMERCIAL GRADE CONSTRUCTION

PERFORMANCE AND SAFETY

Reliable baseboard heaters are strong enough to be used for primary heating and versatile enough to provide supplemental warmth for cold spots and hard-to-reach areas.

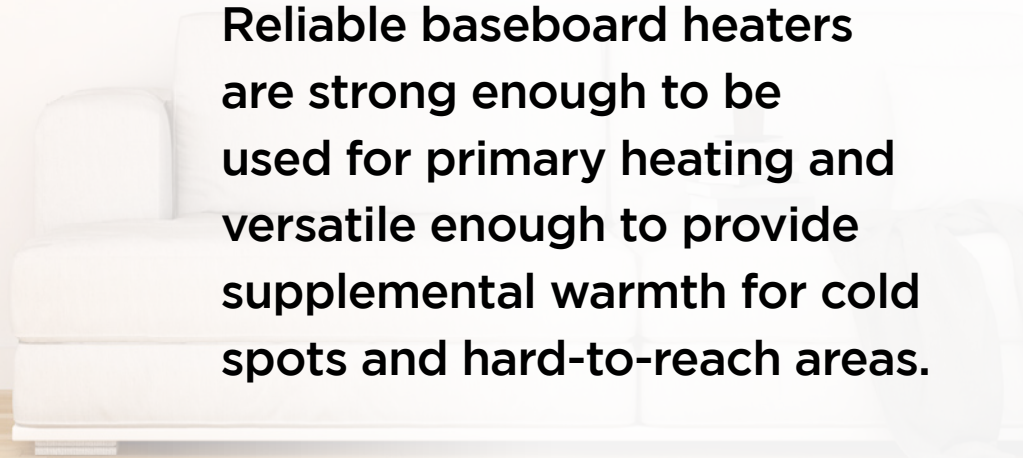

HBB SERIES

Electric Hydronic Baseboard Heater

BASEBOARD



The heater **keeps on radiating warmth**, even after the thermostat shuts off, due to its fluid-immersed, sealed heating element. Its **low-profile design** makes it a perfect fit for bedrooms, bathrooms, living rooms and dens.

Key Features:

Fewer Allergens in the Air

Heat your space without kicking up dust or other allergens. The natural convection airflow doesn't rely on a blower or fan to move warm air throughout the room

Stable, Gentle Heat

Hydronic baseboards put out smooth, steady warmth without large temperature swings. Their sealed-tube heating element heats up quickly and stays that way for a more stable room climate.

Continuous Comfort

Even after the thermostat turns off, this unit continues heating the room, thanks to its fluid-immersed heating element that better retains warmth to keep your room cozy for longer.

Superior Safety

Heavy-duty welded steel louvered grille discourages insertion of foreign objects and low surface temperatures make it safe for installation around pets and children.

Versatile Installation

Built-in wire way, lead wires, and knockouts allow for quick field connection from either end, whether surface mounted on a wall or flat on the floor.

Ideal Spaces:

- Bedrooms
- Living/Family Room
- Basements
- Offices
- Conference Rooms
- Waiting Rooms
- Entrance Ways

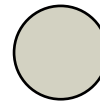

Navajo White



Scan the QR code to access additional specs and features.

HBB SERIES

Electric Hydronic Baseboard Heater

BASEBOARD

Models & Specifications:

ITEM INFORMATION			ELECTRICAL DATA			DIMENSIONAL DATA	
CATALOG NO.	UPC	VOLTS	WATTS	AMPS	LENGTH	SHIP WT.	
◆ HBB504	68536035789	240/208	500/375	2.1/1.8	28"	10 lbs	
◆ HBB754	68536035826	240/208	750/563	3.1/2.7	34"	12 lbs	
◆ HBB1004	68536035635	240/208	1000/750	4.2/3.6	46"	15 lbs	
◆ HBB1254	68536035673	240/208	1250/938	5.2/4.5	58"	19 lbs	
◆ HBB1504	68536035710	240/208	1500/1125	6.3/5.8	70"	22 lbs	
◆ HBB2004	68536035741	240/208	2000/1500	8.3/7.2	94"	30 lbs	
● HBB500	68536035772	120	500	4.2	28"	10 lbs	
● HBB508	68536035802	208	500	2.4	28"	10 lbs	
● HBB750	68536035819	120	750	6.3	34"	12 lbs	
● HBB758	68536035840	208	750	3.6	34"	12 lbs	
● HBB1000	68536035628	120	1000	8.3	46"	15 lbs	
● HBB1008	68536035659	208	1000	4.8	46"	15 lbs	
● HBB1250	68536035666	120	1250	10.4	58"	19 lbs	
● HBB1258	68536035697	208	1250	6	58"	19 lbs	
● HBB1500	68536035703	120	1500	12.5	70"	22 lbs	
● HBB1508	68536035734	208	1500	7.2	70"	22 lbs	
● HBB2008	68536035765	208	2000	9.6	94"	30 lbs	

SKU Legend: ◆ = Popular Products; ● = Extended Offering (Contact your local Marley Sales Representative for typically associated lead times)

Optional Accessories:

CATALOG NO.	UPC	DESCRIPTION	SHIP WT.*
HBBT1	685360035574	25 amp @ 120-277 VAC; Single-Pole Thermostat Snap-Action Type; Field-Installed in Junction Box	1 lbs
HBBT2	685360035598	25 amp @ 120-277 VAC; Double-Pole Thermostat Snap-Action Type; Field-Installed in Junction Box	1 lbs
HBBT1TP	685360035581	Same as Model HBBT1 except Tamper-Resistant	1 lbs
HBBT2TP	685360035604	Same as Model HBBT2 except Tamper-Resistant	1 lbs
HBBAC*	685360035383	Air Conditioner Outlet Section, 20 amps @ 208/240 VAC	2 lbs
HBBDR	685360035420	Duplex Receptacle Section, 15 amps @ 120 VAC	2 lbs
HBBDSDR120	685360147970	Double-Pole Disconnect Switch /120V Receptacle	3 lbs
HBBWS	685360035611	8 in. Blank Wiring Section	1 lbs
HBBLVRO*	685360035475	Low Voltage Relay Control Section, 22 amps @ 120 VAC	3 lbs
HBBLVR8*	685360035505	Low Voltage Relay Control Section, 22 amps @ 208 VAC	3 lbs
HBBLVR4*	685360035482	Low Voltage Relay Control Section, 22 amps @ 240 VAC	3 lbs
HBBDS2	685360035390	Double-Pole Power On/Off Switch Section	2 lbs
CBDIC*	685360014609	Inside Corner	1 lbs
CBDIOC*	685360014616	Outside Corner	1 lbs

*HBBAC - HBBDR - HBBLVR - HBBWS accessories add 8 in. to baseboard length.



HBBT1 & HBBT2



HBBT1TP & HBBT2TP

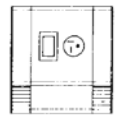

*HBBAC



*HBBDR



*HBBLVR

*Add 8" to length of installation

Dimensions and Clearances:

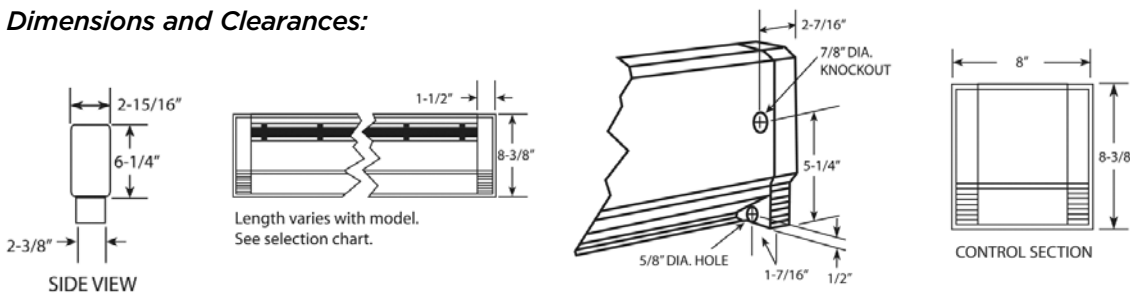

2500 SERIES

Electric Baseboard Heater

BASEBOARD



For **quiet**, comfortable heating, choose these baseboard heaters. These **fan-free heating** units deliver warmth and comfort in a **low-profile housing** that's safe to install on the wall or directly on carpet, tile or other flooring.

Key Features:

Fast-Acting Warmth

Convection heats the room rapidly, without uneven hot and cold zones, providing comfort from floor to ceiling.

Fewer Allergens in the Air

Heat your space without kicking up dust or other allergens. The natural convection airflow doesn't rely on a blower or fan to move warm air throughout the room.

Installs Quickly and Easily

Wire up and connect this baseboard quickly and easily with its large wiring compartment, dual knockouts and built-in cable clamp.

Optimum Efficiency

For maximum efficiency, the unit converts all incoming electric energy into heat, according to Department of Energy standards.

Safe Operation

For worry-free warmth, these UL Listed baseboard heaters offer an overheat protection feature that prevents the unit from running when its air intake is blocked.

Ideal Spaces:

- Bedrooms
- Living/Family Room
- Kitchens
- Basements
- Offices
- Conference Rooms
- Lobbies
- Waiting Rooms
- Bathrooms

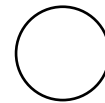

White

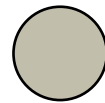

Navajo White



Scan the QR code to access additional specs and features.

2500 SERIES

Electric Baseboard Heater

Models & Specifications:

ITEM INFORMATION			ELECTRICAL DATA			DIMENSIONAL DATA	
CATALOG NO.	UPC	VOLTS	WATTS	AMPS	LENGTH	SHIP WT.	
◆ 2512NW	098319730008	120	400	3.4	24"	5.2 lbs	
◆ 2542NW	098319730022	240/208	400/300	1.7/1.5	24"	5.2 lbs	
◆ 2513NW	098319730084	120	750	6.3	36"	7.5 lbs	
◆ 2543NW	098319730107	240/208	750/564	3.2/2.8	36"	7.5 lbs	
◆ 2514NW	098319730121	120	1000	8.4	48"	10 lbs	
◆ 2544NW	098319730145	240/208	1000/752	4.2/3.7	48"	10 lbs	
◆ 2574NW	098319730152	277/240/208	1000/752/564	3.7/3.2/2.8	48"	10 lbs	
◆ 2545NW	098319730183	240/208	1250/940	5.2/4.6	60"	11.5 lbs	
◆ 2516NW	098319730206	120	1500	12.6	72"	14 lbs	
◆ 2546NW	098319730220	240/208	1500/1128	6.3/5.5	72"	14 lbs	
◆ 2576NW	098319730237	277/240/208	1500/1128/846	5.5/4.7/4.1	72"	14 lbs	
◆ 2548NW	098319730251	240/208	2000/1504	8.4/7.3	96"	18.5 lbs	
● 2502NW	098319730015	208	400	2	24"	5.2 lbs	
● 2572NW	098319730039	277/240/208	400/300/225	1.5/1.3/1.1	24"	5.2 lbs	
● 25126NW	098319730046	120	500	4.2	30"	6.3 lbs	
● 25026NW	098319730053	208	500	2.4	30"	6.3 lbs	
● 25426NW	098319730060	240/208	500/376	2.1/1.9	30"	6.3 lbs	
● 25726NW	098319730077	277/240/208	500/376/282	1.8/1.6/1.4	30"	6.3 lbs	
● 2503NW	098319730091	208	750	3.6	36"	7.5 lbs	
● 2573NW	098319730114	277/240/208	750/564/423	2.7/2.4/2.1	36"	7.5 lbs	
● 2504NW	098319730138	208	1000	4.8	48"	10 lbs	
● 2515NW	098319730169	120	1250	10.5	60"	11.5 lbs	
● 2505NW	098319730176	208	1250	6	60"	11.5 lbs	
● 2575NW	098319730190	277/240/208	1250/940/705	4.6/4.0/3.4	60"	11.5 lbs	
● 2506NW	098319730021	208	1500	7.3	72"	14 lbs	
● 25008NW	098319729811	208	2500	12	96"	18.5 lbs	
● 2508NW	098319730244	208	2000	9.7	96"	18.5 lbs	
● 25408NW	098319729828	240/208	2500/1880	10.5/9.1	96"	18.5 lbs	
● 2578NW	098319730268	277/240/208	2000/1504/1128	7.3/6.3/5.5	96"	18.5 lbs	
● 25708NW	098319729835	277/240/208	2500/1880/1410	9.1/7.9/6.8	96"	18.5 lbs	

SKU Legend: ◆ = Popular Products; ● = Extended Offering (Contact your local Marley Sales Representative for typically associated lead times)

NOTE: Unit and accessories represent White finish. For Navajo White, remove N suffix to catalog number (ex. 2544W). Availability for the Navajo White sku is the exact same as it is for the White sku (ex. 25708W = Extending offering) For high-altitude baseboard heater (mounted above 7,500 ft.), add suffix "H" to catalog number. 8 ft. length baseboards must be ordered in multiples of two pieces for shipment.

Dimensions and Clearances:

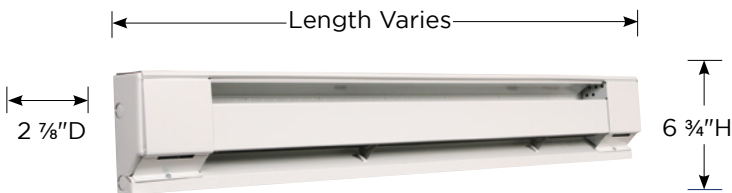

Suggested Controls



TH114A240DBA

MS26 or M601W

2500 SERIES

Electric Baseboard Heater

BASEBOARD

Filler Sections:

CATALOG NO.	UPC	DESCRIPTION	SHIP WT.
FS12NW	098319731500	1 ft. Filler Section	2 lbs
FS24NW	098319731517	2 ft. Filler Section	4 lbs
FS36NW	098319731524	3 ft. Filler Section	6 lbs
FS48NW	098319731531	4 ft. Filler Section	8 lbs
FSJ2NW	731548	2 in. Joiner Strip	.5 lbs

Blank Sections:

CATALOG NO.	UPC	DESCRIPTION	SHIP WT.
BKOCBDA2W	685360009315	2.6 ft. Blank Section	4 lbs
BKOCBDA3W	685360009339	3 ft. Blank Section	5 lbs
BKOCBDA4W	685360009353	4 ft. Blank Section	7 lbs
BKOCBDA5W	685360009377	5 ft. Blank Section	9 lbs
BKOCBDA6W	685360009391	6 ft. Blank Section	11 lbs
BKOCBDA8W	685360009414	8 ft. Blank Section	14 lbs

Optional Controls & Accessories:

CATALOG NO.	UPC	DESCRIPTION	SHIP WT.
TA1ANW	098319730411	SP Thermostat, rated 22A @ 120-277V	1 lbs
TA1TPANW	098319730428	Tamper-Resistant Version of TA1AW	1 lbs
TA2ANW	098319730435	DP Thermostat, rated 22A @ 120-277V	1 lbs
TA2TPANW	098319730442	Tamper-Resistant Version of TA2AW	1 lbs
HCA2415/20NW	098319730466	240V Load Transfer Switch, 20A	1 lbs
HCA1215/20WN	098319730459	120V Load Transfer Switch, 20A	1 lbs
RSA1224	098319714800	120V/24V Transformer Relay, 22A	1 lbs
RSA2024	098319714855	208V/24V Transformer Relay, 22A	1 lbs
RSA2424	098319714909	240V/24V Transformer Relay, 22A	1 lbs
RSA2724	098319714954	277V/24V Transformer Relay, 19A	1 lbs
RA1NW	098319730473	120V Duplex Receptacle	1 lbs
DSW2NW	098319730497	Double-Pole Power On/Off Switch rated 20A @ 120-277V	1 lbs
PR24	098319713674	Single-Pole Power Relay, 24VControl rated 30A @ 120-240V, 23A @ 277V	1 lbs
PRI20	098319713681	Same as PR24 except with 120V Control	1 lbs
ICANW	098319730503	Inside Corner	1 lbs
RA1COMPNW	098319730480	Duplex Receptacle Cover only - carton of 10	1 lbs

NOTE: Unit and accessories represent White finish. For Navajo White, remove N suffix to catalog number (ex. 2544W)

NEW PRODUCT!

WHERE DESIGN AND COMFORT MEET

THX zero vertical profile eliminates visual disruptions while preserving the building's heat envelope and amplifying building aesthetics. Maximize building comfort and reclaim floor space with the most compact, in-floor convector on the market today.

Brought to you by Marley Engineered Products—a trusted leader in comfort solutions—THX is designed with durability in mind to withstand daily cleaning, water and debris.



THX

THE OUT-OF-SIGHT,
OUT-OF-MIND
UL LISTED **IN-FLOOR
PERIMETER HEATER**



Learn more about this revolutionary convector in our digital catalog

Find out how you can incorporate THX into your next supplemental heating spec. Visit CustomHeatSolutions.com/THX-Trench-Heater or contact your Berko representative.

BKOC SERIES

Commercial Baseboard Heater

BASEBOARD



Commercial baseboard heaters provide comfort with **no need for a fan or blower**. Their durable design allows for safe, reliable operation in **high-traffic areas** like hallways, lobbies and waiting rooms.

Key Features:

Fast-Acting Warmth

Convection heats the room rapidly, without uneven hot and cold zones, providing comfort from floor to ceiling.

Fewer Allergens in the Air

Heat your space without kicking up dust or other allergens. The radiant airflow doesn't rely on a blower or fan to move warm air throughout the room.

Durable Design

Add heat and comfort to high-traffic hallways and lobbies. The unit's commercial-grade cold-rolled steel cover and bracket protect the heating mechanism from damage.

Installs Quickly and Easily

Wire up and connect this baseboard quickly and easily with its large wiring compartment, dual knockouts and built-in cable clamp.

Optimum Efficiency

For maximum efficiency, the unit converts all incoming electric energy into heat, according to Department of Energy standards.

Ideal Spaces:

Bedrooms
Living/Family Room
Kitchens
Bathrooms
Basements
Offices
Conference Rooms
Hallways
Waiting Rooms

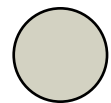

Navajo White

Dimensions and Clearances:

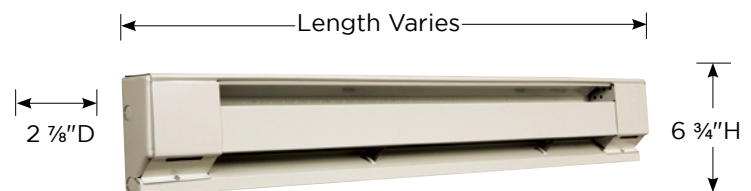

Scan the QR code to access additional specs and features.

BKOC SERIES

Commercial Baseboard Heater

BASEBOARD

Models & Specifications:

ITEM INFORMATION			ELECTRICAL DATA			DIMENSIONAL DATA	
CATALOG NO.	UPC	VOLTS	WATTS	AMPS	LENGTH	SHIP WT.	
● BKOC25126W	685360010090	120	500	4.2	30"	7.8 lbs	
● BKOC25026W	685360009858	208	500	2.4			
● BKOC25426W	685360010366	240/208	500/376	2.1/1.8			
● BKOC25726W	685360010670	277/240/208	500/376/282	1.8/1.6/1.4	36"	9.0 lbs	
● BKOC2513W	685360010137	120	750	6.5			
● BKOC2503W	685360009896	208	750	3.6			
● BKOC2543W	685360010403	240/208	750/564	3.1/2.7	48"	11.5 lbs	
● BKOC2573W	685360010717	277/240/208	750/564/423	2.7/2.4/2.0			
● BKOC2514W	685360010175	120	1000	8.3			
● BKOC2504W	685360009933	208	1000	4.8	60"	13.0 lbs	
● BKOC2544W	685360010441	240/208	1000/752	4.2/3.6			
● BKOC2574W	685360010755	277/240/208	1000/752/564	3.6/3.1/2.7			
● BKOC2515W	685360010212	120	1250	10.4	72"	15.5 lbs	
● BKOC2505W	685360009971	208	1250	6.0			
● BKOC2545W	685360010489	240/208	1250/940	5.2/4.5			
● BKOC2575W	685360010793	277/240/208	1250/940/705	4.5/3.9/3.4	96"	20 lbs	
● BKOC2516W	685360010250	120	1500	12.6			
● BKOC2506W	685360010014	208	1500	7.2			
● BKOC2546W	685360010526	240/208	1500/1128	6.3/5.4	96"	20 lbs	
● BKOC2576W	685360010830	277/240/208	1500/1128/846	5.4/4.7/4.1			
● BKOC2508W	685360010052	208	2000	9.6			
● BKOC2548W	685360010564	240/208	2000/1504	8.3/7.2	96"	20 lbs	
● BKOC2578W	685360010878	277/240/208	2000/1504/1128	7.2/6.3/5.4			
● BKOC25008W	685360009810	208	2500	12.0			
● BKOC25408W	685360010328	240/208	2500/1880	10.4/8.7	96"	20 lbs	
● BKOC25708W	685360010632	277/240/208	2500/1880/1410	9.0/7.5/6.8			

SKU Legend: ● = Popular Products; ● = Extended Offering (Contact your local Marley Sales Representative for typically associated lead times)

Filler Sections:

CATALOG NO.	UPC	DESCRIPTION	SHIP WT.
FS12	098319731500	1 ft. Filler Section	2 lbs
FS24	098319731517	2 ft. Filler Section	4 lbs
FS36	098319731524	3 ft. Filler Section	6 lbs
FS48	098319731531	4 ft. Filler Section	8 lbs
FSJ2	731548	2 in. Joiner Strip	.5 lbs

Blank Sections:

CATALOG NO.	UPC	DESCRIPTION	SHIP WT.
BKOCBDA2W	685360009315	2.6 ft. Blank Section	4 lbs
BKOCBDA3W	685360009339	3 ft. Blank Section	5 lbs
BKOCBDA4W	685360009353	4 ft. Blank Section	7 lbs
BKOCBDA5W	685360009377	5 ft. Blank Section	9 lbs
BKOCBDA6W	685360009391	6 ft. Blank Section	11 lbs
BKOCBDA8W	685360009414	8 ft. Blank Section	14 lbs

Optional Controls & Accessories:

CATALOG NO.	UPC	DESCRIPTION	SHIP WT.
TA1AW	098319730411	SP Thermostat, rated 22A @ 120-277V	1 lbs
TA1PAW	098319730428	Tamper-Resistant Version of TA1AW	1 lbs
TA2AW	098319730435	DP Thermostat, rated 22A @ 120-277V	1 lbs
TA2PAW	098319730442	Tamper-Resistant Version of TA2AW	1 lbs
HCA2415/20W	098319730466	240V Load Transfer Switch, 20A	1 lbs
HCA1215/20W	098319730459	120V Load Transfer Switch, 20A	1 lbs
RSA1224	098319714800	120V/24V Transformer Relay, 22A	1 lbs
RSA2024	098319714855	208V/24V Transformer Relay, 22A	1 lbs
RSA2424	098319714909	240V/24V Transformer Relay, 22A	1 lbs
RSA2724	098319714954	277V/24V Transformer Relay, 19A	1 lbs
RA1W	098319730473	120V Duplex Receptacle	1 lbs
DSW2W	098319730497	Double-Pole Power On/Off Switch rated 20A @ 120-277V	1 lbs
PR24	098319713674	Single-Pole Power Relay, 24VControl rated 30A @ 120-240V, 23A @ 277V	1 lbs
PRI20	098319713681	Same as PR24 except with 120V Control	1 lbs
ICANW	098319730503	Inside Corner	1 lbs
RA1COMPW	098319730480	Duplex Receptacle Cover only - carton of 10	1 lbs

NOTE: For high-altitude baseboard heater (mounted above 7,500 ft.), add suffix "H" to catalog number. 8 ft. length baseboards must be ordered in multiples of two pieces for shipment.

Suggested Controls



A blanket of warmth for hard-to-heat areas

Radiant technology works like the sun's rays to put warmth right where you need it — without having to heat (or pay for heating) the surrounding air.

Customizations AVAILABLE*



Transit Station

Stadium

Loading Dock

Open-Air Dining

Barn

Offices & Basements

Why Radiant Heating

SAVE ON ENERGY & MAINTENANCE COSTS

By transferring warmth directly, radiant heaters don't waste energy heating the surrounding air. With no filters or moving parts to maintain, they are less costly to service as well.

HEAT WHERE AND WHEN YOU NEED IT

As a direct heat source, radiant output is unaffected by wind and rain. Berko radiant heaters can be used for everything from snow removal to cozying up counter and desk areas.

CLEANER ALTERNATIVE TO GAS HEATING

Berko radiant heaters can be installed in tight spaces with little to no clearance. There's no need for ducting or exhaust, so these heaters operate cleanly without circulating dust or fumes.

Versatile, Superior Value Both Indoors and Outdoors



Instant & Targeted Heat: Infrared energy delivers direct, uniform and localized heat — heating people and objects rather than the air, just like the sun.



Clean & Safe Heat: No fumes, odors or combustion. Does not circulate dust or other irritants and allergens.



Energy Efficient: Optimized shortwave infrared energy delivers continuous comfort efficiently without energy waste due to the wind and heating of the surrounding air.



Easy to Install: No need for gas lines, ducting or venting. Install in compact spaces.



Low Maintenance: No filters or moving parts to service.



Money Savings: Minimal upfront costs due to material and labor. Minimal energy usage and no need to purchase propane or other fuels to maintain operation.

*Customizations not available for all products.

CP SERIES

Radiant Ceiling Panels



RADIANT HEATERS

Radiant ceiling panels go where other comfort solutions can't. With three mounting options, they can **fit any ceiling space**, helping to offset heat loss through perimeter windows and entrances. Install them in your bathroom, office or studio —anywhere you need to keep warm and **conserve floor space** for activities.

Key Features:

The Clear Choice

Keep floor and wall space free for use with radiant ceiling panels. They are compatible with almost any ceiling type and make a welcome addition to any cold room.

Save Money and Energy

By offsetting heat loss efficiently, radiant ceiling panels are able to keep you comfortable without overtaxing your main HVAC system or your energy budget.

Easy Operation

Radiant ceiling panels put out heat with no moving parts. This makes them quieter to operate and also lowers their maintenance cost.

Preserve Your Heating Envelope

Radiant ceiling panels provide clean, gentle, comfortable heat. This makes them a perfect choice for offsetting heat loss in drafty spaces and rooms with large windows.

Keep Clear

With no fan or exhaust, radiant ceiling panels heat without drying out room air. This also reduces the need to clear settled dust and particles from your ceilings, walls and drapes.



Scan the QR code to access additional specs and features.

Technical Specifications:

Dimensions: 2'x2' 2'x4' and Custom Sizing Available

Ideal Spaces:

Living/Family Room
Offices & Retail Spaces
Hallways & Lobbies
Conference Rooms
Locker Rooms & Bathrooms
Laboratories
Yoga Studios
Bedrooms
Basements

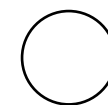

White



Custom Colors and Silkscreens Available

Models & Specifications:

ITEM INFORMATION			ELECTRICAL DATA				DIMENSIONAL DATA	
CATALOG NO.	UPC	VOLTS	WATTS	BTU/HR	AMPS	SIZE	SHIP WT.	
◆ CP371F	68536016757	120	375	1280	3.1	2' x 2'	15 lbs	
◆ CP378F	68536016856	208	375	1280	1.8	2' x 2'	15 lbs	
◆ CP372F	68536016764	240	375	1280	1.6	2' x 2'	15 lbs	
◆ CP501F	68536016917	120	500	1706	4.2	2' x 4'	28 lbs	
◆ CP508F	68536016962	208	500	1706	2.4	2' x 4'	28 lbs	
◆ CP502F	68536016924	240	500	1706	2.1	2' x 4'	28 lbs	
◆ CP621F	68536016979	120	625	2133	5.2	2' x 4'	28 lbs	
◆ CP628F	68536017075	208	625	2133	3.0	2' x 4'	28 lbs	
◆ CP622F	68536016986	240	625	2133	2.6	2' x 4'	28 lbs	
◆ CP751F	68536017136	120	750	2559	6.3	2' x 4'	28 lbs	
◆ CP758F	68536017181	208	750	2559	3.6	2' x 4'	28 lbs	
◆ CP752F	68536017143	240	750	2559	3.1	2' x 4'	28 lbs	
● CP251F	68536016580	120	250	853	2.1	2' x 2'	15 lbs	
● CP258F	68536016634	208	250	853	1.2	2' x 2'	15 lbs	
● CP252F	68536016597	240	250	853	1.0	2' x 2'	15 lbs	
● CP257F	68536016627	277	250	853	0.9	2' x 2'	15 lbs	
● CP311F	68536016696	120	310	1058	2.6	2' x 2'	15 lbs	
● CP318F	68536016740	208	310	1058	1.5	2' x 2'	15 lbs	
● CP312F	68536016702	240	310	1058	1.3	2' x 2'	15 lbs	
● CP317F	68536016719	277	310	1058	1.1	2' x 2'	15 lbs	
● CP377F	68536016771	277	375	1280	1.4	2' x 2'	15 lbs	
● CP507F	68536016955	277	500	1706	1.8	2' x 4'	28 lbs	
● CP627F	68536017068	277	625	2133	2.3	2' x 4'	28 lbs	
● CP757F	68536017174	277	750	2559	2.7	2' x 4'	28 lbs	
● CP253F	68536016603	347	250	853	0.7	2' x 2'	15 lbs	
● CP313F	68536016733	347	310	1058	0.9	2' x 2'	15 lbs	
● CP373F	68536016849	347	375	1280	1.1	2' x 2'	15 lbs	
● CP503F	68536016931	347	500	1706	1.4	2' x 4'	28 lbs	
● CP623F	68536016993	347	625	2133	1.8	2' x 4'	28 lbs	
● CP753F	68536017150	347	750	2559	2.1	2' x 4'	28 lbs	

SKU Legend: ◆ = Popular Products; ● = Extended Offering (Contact your local Marley Sales Representative for typically associated lead times)

NOTE: When ordering panels with custom features, the catalog number will change. Please see next page for more information on made to order custom products.

Optional Accessories:

CATALOG NO.	UPC	DESCRIPTION
QSF2424	685360201843	Surface Mounting Frame for 24" x 24" Panels
QSF2448	685360201850	Surface Mounting Frame for 24" x 48" Panels
QRF2424	685360201867	Recess Mounting Frame for 24" x 24" Panels
QRF2448	685360201874	Recess Mounting Frame for 24" x 48" Panels

NOTE: Heating panels do not have a fire or hazardous rating, but construction is of fire retardant materials. Panels normally are treated like light fixtures. If necessary, acoustical tile can be placed on top of the panels.

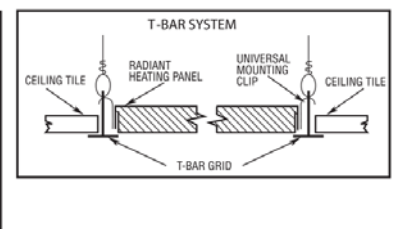
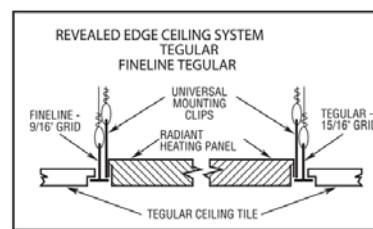
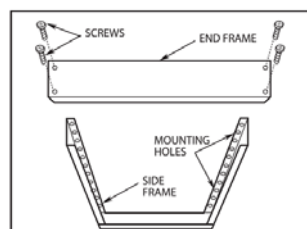
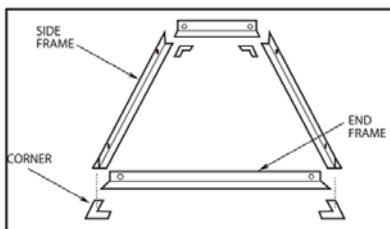
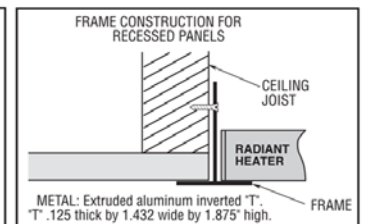
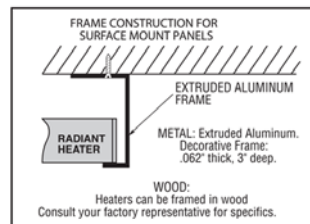

NOTE: Heating panels do not have a fire or hazardous rating, but construction is of fire retardant materials. Panels normally are treated like light fixtures. If necessary, acoustical tile can be placed on top of the panels.



For gentle heating in spaces **where wall space is at a premium**, select a cove heater. It **mounts easily** on the wall, providing warmth for your living room, bedroom, bathroom, basement or office.

Key Features:

Fanless Operation

This cove heater's radiant design allows it to warm the room without the use of a fan, for less noise and circulation of particles in the air.

Easy to Maintain

The lack of moving parts means this unit can function well over the long term without the wear and tear associated with motors and fans that break down over time.

Uniform Comfort

With an aluminum front panel coated with high temperature textured paint, this cove heater focuses on radiating as much heat energy as possible into the room.

Out of Reach

The cove heater is ideal for those spaces where occupant safety is top of mind and quiet operation is desired. Installed high up on the wall and out of reach of occupants, the cove heater delivers clean, gentle comfort to the space.

Technical Specifications:

Length: 34"-132"

Output: 450-1800 watts

Ideal Spaces:

Offices & Retail Spaces
Hallways & Lobbies
Conference Rooms
Day Care Centers
Geriatric Facilities
Laboratories
Living Room & Kitchens
Bathrooms
Basements

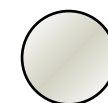

Textured White



Scan the QR code to access additional specs and features.

RCC SERIES

Cove Heater

RADIANT HEATERS

Models & Specifications:

ITEM INFORMATION			ELECTRICAL DATA				DIMENSIONAL DATA	
CATALOG NO.	UPC	VOLTS	WATTS	BTUs	AMPS	LENGTH	SHIP WT.	
◆ RCC4524C	685360147192	240	450	1536	2.2	34"	4 lbs	
◆ RCC6024C	685360147222	240	600	2048	2.5	47"	6 lbs	
◆ RCC7524C	685360147260	240	750	2560	3.1	59"	7 lbs	
◆ RCC9024C	685360147307	240	900	3072	3.7	71"	8 lbs	
◆ RCC10524C	685360147451	240	1050	3583	4.4	83"	9 lbs	
◆ RCC12024C	685360147376	240	1200	4095	5.0	94"	10 lbs	
◆ RCC15024C	685360147406	240	1500	5120	6.2	118"	13 lbs	
◆ RCC18008C	685360147420	208	1800	6142	8.7	132"	15 lbs	
● RCC4512C	685360147185	120	450	1536	2.2	34"	4 lbs	
● RCC4508C	685360147178	208	450	1536	2.2	34"	4 lbs	
● RCC6012C	685360147215	120	600	2048	5.0	47"	6 lbs	
● RCC6008C	685360147208	208	600	2048	2.9	47"	6 lbs	
● RCC6027C	685360147239	277	600	2048	2.2	47"	6 lbs	
● RCC7512C	685360147253	120	750	2560	6.2	59"	7 lbs	
● RCC7508C	685360147246	208	750	2560	3.6	59"	7 lbs	
● RCC7527C	685360147277	277	750	2560	2.7	59"	7 lbs	
● RCC9012C	685360147291	120	900	3072	7.5	71"	8 lbs	
● RCC9008C	685360147284	208	900	3072	4.3	71"	8 lbs	
● RCC9027C	685360147314	277	900	3072	3.2	71"	8 lbs	
● RCC10512C	685360147338	120	1050	3583	8.8	83"	9 lbs	
● RCC10508C	685360147321	208	1050	3583	5.0	83"	9 lbs	
● RCC10527C	685360147345	277	1050	3583	3.8	83"	9 lbs	
● RCC12012C	685360147369	120	1200	4095	10.0	94"	10 lbs	
● RCC12008C	685360147352	208	1200	4095	5.8	94"	10 lbs	
● RCC12027C	685360147383	277	1200	4095	4.3	94"	10 lbs	
● RCC15008C	685360147390	208	1500	5120	7.2	118"	13 lbs	
● RCC15027C	685360147413	277	1500	5120	5.4	118"	13 lbs	
● RCC18024C	685360147437	240	1800	6142	7.5	132"	15 lbs	
● RCC18027C	685360147444	277	1800	6142	6.5	132"	15 lbs	

SKU Legend: ◆ = Popular Products; ● = Extended Offering (Contact your local Marley Sales Representative for typically associated lead times)

Optional Accessories:

CATALOG NO.	UPC	DESCRIPTION	SHIP WT.
RCCT	685360065663	Integral Thermostat: Range 45-90°F with Positive Off	1 lbs
RCCSPC	685360147666	Splice Plate Assembly	2 lbs

Dimensions and Clearances:

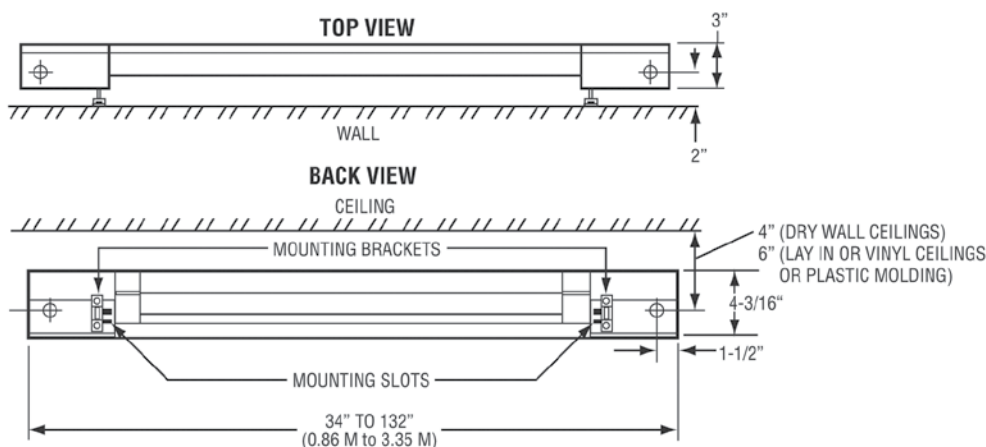

Introduction

Infrared technology permits the heating of areas where it is impractical, either economically or physically, to heat air. The physics that causes warm air to rise and cool air to fall are constantly working against forced air heating systems, particularly in outdoor or high ceiling areas. The radiant heat energy emitted by infrared heaters is transferred direct to the people and objects under them. It is the same principle that allows the sun to make a clear, cold day feel warm. The radiant energy from infrared heaters can be directed and focused in any direction to evenly blanket people and equipment with comforting warmth, free from drafts and noisy fans or blowers.

Selecting the Right Models

Keep in mind these elements when selecting the correct infrared heater for your needs. **Consult your MEP sales representative for additional design assistance.**

- 1. Type of application:** area heating, snow melting, or spot heating
- 2. Type of environment:** outdoors, indoors, marine or corrosive atmospheres
- 3. Design area:** square footage, objects/people standing or sitting
- 4. Watt density required to maintain comfort**
- 5. Mounting height**

6. Selecting Proper Heat Pattern

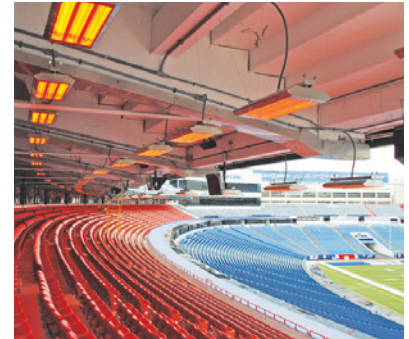
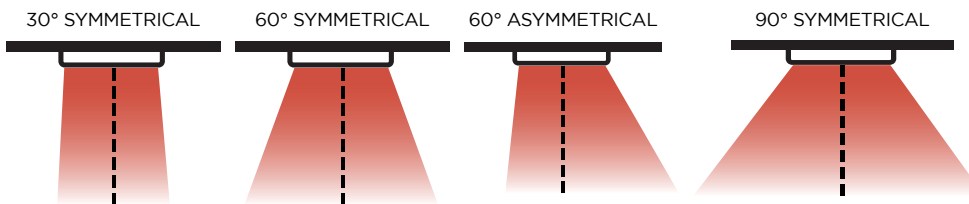

7. Selecting Proper Heating Elements

Metal Sheath
High Traffic Areas

- Impact ✓✓✓
- Vibration ✓✓✓
- Splashing ✓✓✓
- Wind ✓

Quartz Tube
Indoor/Outdoor Area/Spot Heating

- Impact ✓
- Vibration ✓
- Splashing ✓✓✓
- Wind ✓✓

Quartz Lamp
High Bays, Snow Melting

- Impact ✓
- Vibration ✓
- Splashing ✓✓
- Wind ✓✓✓

RESPONSE TIME, EFFICIENCY, INTENSITY/OUTPUT

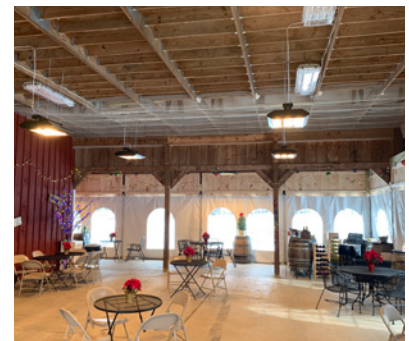

8. Product Selection After determining the requirements above, visit the product portion of our catalog to select appropriately sized heaters for your application. Contact your sales representative for more information on which infrared heaters will work for your specific application.

9. Control Optimization For the optimal preforming solution, it is important to understand how the application space should be controlled. Marley offers a variety of control solutions for various types of application needs. Please consult your sales representative for more information on which control options are ideal for your specific application.



VRP/VRS SERIES

Commercial/Industrial Infrared Heater

RADIANT HEATERS



For **indoor/outdoor heating**, choose these painted steel or stainless steel infrared heaters. When added to your workshop, warehouse, gym or pool, they provide excellent spot heating or total comfort that is **unaffected by outside drafts**.

Key Features:

The Right Heat for the Right Space

Dual and triple element models concentrate your heating capacity efficiently without the need to add more individual units.

Flexible Design

Metal sheath, quartz tube and quartz lamp heating elements can all be used interchangeably with these infrared heaters, allowing for flexible operation even when environmental conditions change.

Aim Your Heat

The heavy duty gold-anodized reflectors in this unit allow you to focus your heating pattern in any one of several configurations.

Rugged and Reliable

This infrared heater's steel internal parts and high quality finish make it a reliable, easy to maintain choice for harsh industrial environments or where coastal salt air or other corrosive conditions are present.

Steel Strength

The 20-gauge galvanized steel enclosure and wiring compartment is finished with a statuary bronze powder coat for extra durability and a refined look.

Technical Specifications:

Element Types: Metal Sheath, Quartz Tube, Quartz Lamp

Reflection Angles: 30° Sym., 60° Sym., 60° Asym., 90° Sym.

Ideal Spaces:

Parking Garages
Arenas & Showrooms
Workshops & Gymnasiums
Loading Docks & Warehouses
Aircraft Hangers
Swimming Pools & Ski Resorts
Walkways & Entryways
Sports Arenas & Driving Ranges
Bus Stops & Smoking Areas

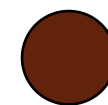

Bronze

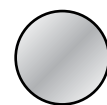

Stainless Steel



Scan the QR code to access additional specs and features.

VRP/VRS SERIES

Commercial/Industrial Infrared Heater

RADIANT HEATERS

Models & Specifications – 2-Element Enclosure:

ITEM INFORMATION					DIMENSIONAL DATA				
	PAINTED.		STAINLESS		REFLECTIVE ANGLE	HEIGHT	WIDTH	DEPTH	SHIP WT.
	CATALOG NO	UPC	CATALOG NO	UPC					
●	VRP223S	685360075051	VRS223S	685360030517	30° Sym	7.125"	15"	24"	19 lbs
●	VRP226S	685360075211	VRS226S	685360030678	60° Sym				
●	VRP226AS	685360075136	VRS226AS	685360030593	60° Asym				
●	VRP229S	685360075297	VRS229S	685360030753	90° Sym				
●	VRP233S	685360075457	VRS233S	685360030753	30° Sym	7.125"	15"	33"	24 lbs
●	VRP236S	685360075600	VRS236S	685360030913	60° Sym				
●	VRP236AS	685360075525	VRS236AS	685360031071	60° Asym				
●	VRP239S	685360075686	VRS239S	685360030999	90° Sym				
●	VRP243S	685360075815	VRS243S	685360031156	30° Sym	7.125"	15"	46"	31 lbs
●	VRP246S	685360075914	VRS246S	685360031385	60° Sym				
●	VRP246AS	685360075860	VRS246AS	685360031330	60° Asym				
●	VRP249S	685360075969	VRS249S	685360031439	90° Sym				

Models & Specifications – 3-Element Enclosure:

ITEM INFORMATION					DIMENSIONAL DATA				
	PAINTED.		STAINLESS		REFLECTIVE ANGLE	HEIGHT	WIDTH	DEPTH	SHIP WT.
	CATALOG NO	UPC	CATALOG NO	UPC					
●	VRP323S	685360076096	VRS323S	685360031569	30° Sym	7.125"	21.5"	24"	23 lbs
●	VRP326S	685360076256	VRS326S	685360031729	60° Sym				
●	VRP326AS	685360076771	VRS326AS	685360031644	60° Asym				
●	VRP329S	685360076331	VRS329S	685360031804	90° Sym				
●	VRP333S	685360076492	VRS333S	685360031972	30° Sym	7.125"	21.5"	33"	31 lbs
●	VRP336S	685360076652	VRS336S	685360032139	60° Sym				
●	VRP336AS	685360029832	VRS336AS	685360032054	60° Asym				
●	VRP339S	685360076737	VRS339S	685360032214	90° Sym				
●	VRP343S	685360076867	VRS343S	685360032344	30° Sym	7.125"	21.5"	46"	39 lbs
●	VRP346S	685360076966	VRS346S	685360032443	60° Sym				
●	VRP346AS	685360076911	VRS346AS	685360032399	60° Asym				
●	VRP349S	685360077017	VRS349S	685360032498	90° Sym				

SKU Legend: ● = Popular Products; ● = Extended Offering (Contact your local Marley Sales Representative for typically associated lead times)

Optional Accessories:

CATALOG NO.	UPC	DESCRIPTION	COMPATIBLE WITH	CARTONS	SHIP WT.
VWG22	685360084756	Wire Guard for 2-Element Heaters	VRS2/VRP2 (24 in. L)	1	1 (454) lbs
VWG23	685360084763	Wire Guard for 2-Element Heaters	VRS2/VRP2 (33 in. L)	1	1.5 (680) lbs
VWG24	685360084770	Wire Guard for 2-Element Heaters	VRS2/VRP2 (46 in. L)	1	2 (907) lbs
VWG32	685360084787	Wire Guard for 3-Element Heaters	VRS2/VRP2 (24 in. L)	1	1.5 (680) lbs
VWG33	685360084794	Wire Guard for 3-Element Heaters	VRS2/VRP2 (33 in. L)	1	2 (907) lbs
VWG34	685360084800	Wire Guard for 3-Element Heaters	VRS2/VRP2 (46 in. L)	1	2.5 (1134) lbs
VRPATMB	685360084022	Adjustable Tilt Mounting Bracket – VRP Series		1 Set	1 (454) lbs
VRSATMB	685360084046	Adjustable Tilt Mounting Bracket – VRS Series		1 Set	1 (454) lbs
VRPWMB	685360084039	Wall Mounting Bracket – VRP Series		1 Set	6 (2722) lbs
VRSWMB	685360084053	Wall Mounting Bracket – VRS Series		1 Set	6 (2722) lbs
RVS2	685360137650	24 in. Red Vycor sleeve	VR(*)22/VR(*)32	1	-
RVS3	685360137667	33 in. Red Vycor sleeve	VR(*)23/VR(*)33	1	-
RVS4	685360137674	46 in. Red Vycor sleeve	VR(*)24/VR(*)34	1	-

(1) One element per carton order. * Denotes remaining catalog number (See Enclosure Chart).

VRP/VRS SERIES

Commercial/Industrial Infrared Heater

RADIANT HEATERS

Element Selection Chart¹

ITEM INFORMATION			ELECTRICAL DATA					SHIP WT.
CATALOG NO.	UPC	VOLTS	WATTS	BTU	TYPE	COMPATIBLE WITH		
● V2MS08208	685360032757	208	850	2,900	Metal Sheath	VRP22 (24 in. L)	1 lbs	
● V2MS08240	685360032764	240						
● V2MS08277	685360032771	277						
● V2MS08347	685360032788	347						
● V2MS08480	685360032801	480						
● V2MS08600	685360032818	600						
● V2QT10208	685360032894	208	1000	3,412	Quartz Tube	VRS22 (24 in. L)	1 lbs	
● V2QT10240	685360032900	240						
● V2QT10277	685360032917	277						
● V2QL16208	685360032825	208	1600	5,459	Quartz Lamp	VRS32 (24 in. L)	1 lbs	
● V2QL16240	685360032832	240						
● V2QL16277	685360032849	277						
● V2QL16347	685360032856	347						
● V2QL16480	685360032870	480						
● V2QL16600	685360032887	600						
● V3MS15208	685360033235	208	1500	5,118	Metal Sheath	VRP23 (33 in. L)	1 lbs	
● V3MS15240	685360033242	240						
● V3MS15277	685360033259	277						
● V3MS15347	685360033266	347						
● V3MS15480	685360033280	480						
● V3MS15600	685360033297	600						
● V3QT15208	685360033372	208	1500	5,118	Quartz Tube	VRS23 (33 in. L)	1 lbs	
● V3QT15240	685360033389	240						
● V3QT15277	685360033396	277						
● V3QT15347	685360033402	347						
● V3QT15480	685360033426	480						
● V3QT15600	685360033433	600						
● V3QL25208	685360033303	208	2500	8,530	Quartz Lamp	VRP33 (33 in. L)	1 lbs	
● V3QL25240	685360033310	240						
● V3QL25277	685360033327	277						
● V3QL25347	685360033334	347						
● V3QL25480	685360033358	480						
● V3QL25600	685360033365	600						
● V4MS20208	685360033440	208	2000	6,824	Metal Sheath	VRP24 (46 in. L)	1 lbs	
● V4MS20240	685360033457	240						
● V4MS20277	685360033464	277						
● V4MS20347	685360033471	347						
● V4MS20480	685360033495	480						
● V4MS20600	685360033501	600						
● V4QT20208	685360033556	208	2000	6,824	Quartz Tube	VRS24 (46 in. L)	1 lbs	
● V4QT20240	685360033563	240						
● V4QT20277	685360033570	277						
● V4QT20347	685360033587	347						
● V4QT20480	685360033600	480						
● V4QT20600	685360033617	600						
● V4QL36347	685360033518	347	3650	12,454	Quartz Lamp	VRS34 (46 in. L)	1 lbs	
● V4QL36480	685360033532	480						
● V4QL36600	685360033549	600						

2-Element Enclosure:

	MAXIMUM WATTAGE		
	METAL SHEATH	QUARTZ TUBE	QUARTZ LAMP
24"	1,700	2,000	3,200
33"	3,000	3,000	5,000
46"	4,000	4,000	7,300

3-Element Enclosure:

	MAXIMUM WATTAGE		
	METAL SHEATH	QUARTZ TUBE	QUARTZ LAMP
24"	2,500	3,000	,800
33"	4,500	4,500	7,500
46"	6,000	6,000	10,950

MOUNTING CLEARANCES

- 24 in. to vertical side walls
- 36 in. between heaters mounted side by side. Heaters may be mounted end to end.
- 6 in. to ceiling
- 84 in. to floor

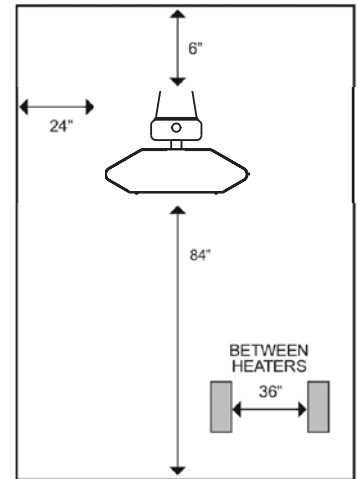

SKU Legend: ● = Popular Products; ● = Extended Offering (Contact your local Marley Sales Representative for typically associated lead times)
¹Metal Sheathed: used indoors or outdoors in high-traffic areas; Quartz Tube and Quartz Lamp: used indoors and outdoors for snow melting and spot heating. **Finish not intended for direct salt spray exposure in marine applications or highly corrosive greenhouse, swimming pool, chemical storage or industrial atmospheres. Maintain at least 5 ft. in radiant path, between bottom of heater and combustible material. Pigtail element leads for a more positive connection in high-traffic areas where physical abuse.



Key Features:

Multiple Configurations

Factory-wired for efficient installations and include terminal blocks, on/off selector switches, power ON pilot light, and a 24V or 120V control circuit. Control transformer with fused primary and secondary.

Wide Range of Electrical Specifications

Panels are available for use in 208V, 240V, 277V, 480V and 600V systems, with amp loads up to 40, 50, 100, 200 and 300 amps (inductive load—see chart below for resistive load rating).

Durable Construction

NEMA 1 enclosure, UL/cUL listed and labeled control panel.

Models & Specifications:

ITEM INFORMATION				ELECTRICAL DATA			DIMENSIONAL DATA	
CATALOG NO.	UPC	DESCRIPTION	AMPS*	VOLTS	SUPPLY VOLTS	DIMENSIONS	SHIP WT.	
CP404801PT	685360138930	Percentage Timer Panel, (1) 3-Pole Contactor	40A	208-480V	120V	14.5" H x 14.5" W x 7.5" D	45 lbs	
CP404801CT	685360138923	Time Delay Controller, (1) 3-Pole Contactor	40A	208-480V	120V	14.5" H x 14.5" W x 7.5" D	45 lbs	
CP504801	685360139005	(1) 3-Pole Contactor Panel	40A	208-480V	120V	14.5" H x 14.5" W x 7.5" D	45 lbs	
CP1004801	685360138800	(2) 3-Pole Contactor Panel	100A	208-480V	120V	14" H x 15" W x 7.75" D	55 lbs	
CP2004801	685360138848	(4) 3-Pole Contactor Panel	200A	208-480V	120V	31.5" H x 18.2" W x 10" D	65 lbs	
CP3004801	685360138886	(6) 3-Pole Contactor Panel	300A	208-480V	120V	36" H x 30" W x 7" D	70 lbs	

SKU Legend: ◆ = Popular Products; ● = Extended Offering (Contact your local Marley Sales Representative for typically associated lead times)

*Amp rating inductive load. Line fusing supplied by installer. Percentage Timer Panel for Metal Sheath Heaters only. Contact factory for 24V control, 600V supply, and Nema 4 enclosures. Add 25% to list price for stainless steel (NEMA 4x) rating.



Scan the QR code to access additional specs and features.

NEW PRODUCT!



Learn more about this flipable duct heater in our digital catalog

New Energy Efficiency Ratings for COMMERCIAL AND INDUSTRIAL CEILING FANS

Learn more on page 105

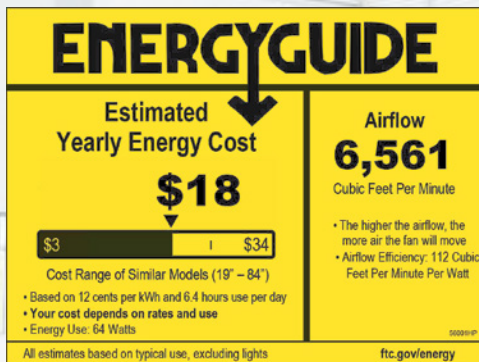

56001HP

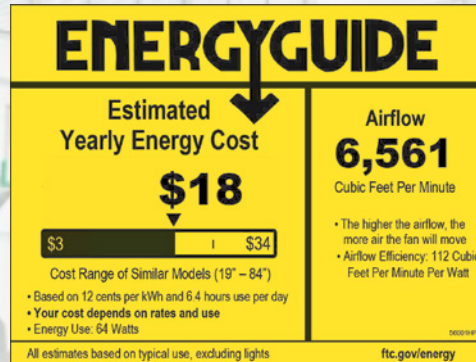

60001HP

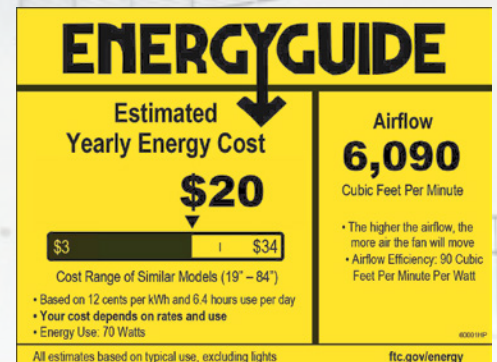

56007HP

JRK SERIES

Commercial/Industrial Single-Element Infrared Heater

RADIANT HEATERS

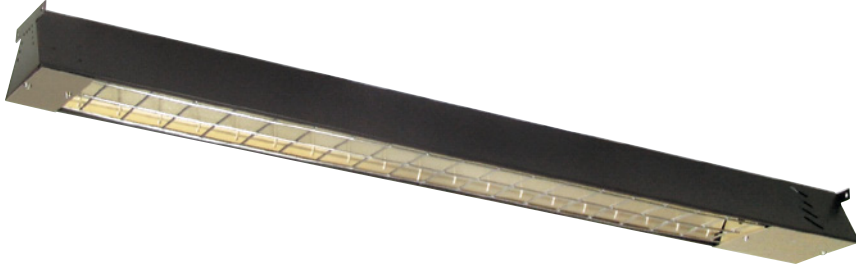

These infrared heaters work well in garages, loading docks, hangars and warehouses. Their single quartz element provides reliable output that is **unaffected by outside air movement and drafts.**

Key Features:

Rugged and Reliable

This infrared heater's steel internal parts and high quality finish make it a reliable, easy to maintain choice for industrial environments where durability is key. Water resistant for outdoor adjacent spaces.

Elite Heat

A heavy duty gold-anodized reflector allows this heater to deliver one of the highest levels of radiant heat energy possible.

Flexible Mounting

Chains are included for easy suspended ceiling applications. An optional wall mounting bracket allows you to approach your heating needs from other angles as well.

Safety Screen

Install the optional HWG wire guard to create a preventative barrier that stops foreign objects from contacting the heating element.

Technical Specifications:

Element Type: Quartz Lamp

Reflection Angles: 60deg Sym.

Ideal Spaces:

Parking Garages
Showrooms
Work Stations
Loading Docks
Aircraft Hangers
Warehouses



Intertek

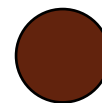

Bronze



**Scan the QR code to access
additional specs and features.**

JRK SERIES

Commercial/Industrial Single-Element Infrared Heater

RADIANT HEATERS

Models & Specifications:

ITEM INFORMATION		ELECTRICAL DATA				DIMENSIONAL DATA	
CATALOG NO.	UPC	VOLTS	WATTS	BTUs	AMPS	HEIGHT	SHIP WT.
● JRK41512	685360082950	120	1500	5,118	12.5	46"	9 lbs
● JRK42020	685360082967	208	2000	6,824	9.6	46"	9 lbs
● JRK42024	685360082974	240	2000	6,824	8.3	46"	9 lbs
● JRK53020	685360083032	208	3000	10,236	14.4	57"	11 lbs
● JRK53024	685360083049	240	3000	10,236	12.5	57"	11 lbs
● JRK42027	685360082981	277	2000	6,824	7.2	46"	9 lbs
● JRK42034	685360082998	347	2000	6,824	5.8	46"	9 lbs
● JRK42048	685360083018	480	2000	6,824	4.2	46"	9 lbs
● JRK42060	685360083025	600	2000	6,824	3.3	46"	9 lbs
● JRK53027	685360083056	277	3000	10,236	10.8	57"	11 lbs
● JRK53034	685360083063	347	3000	10,236	8.6	57"	11 lbs
● JRK53048	685360083087	480	3000	10,236	6.3	57"	11 lbs
● JRK53060	685360083094	600	3000	10,236	5.0	57"	11 lbs

SKU Legend: ◆ = Popular Products; ● = Extended Offering (Contact your local Marley Sales Representative for typically associated lead times)

NOTE: Quartz Lamp: used indoors for spot heating. Maintain at least 5 ft. in radiant path, between bottom of heater and combustible material. Pigtail element leads for a more positive connection in high-traffic areas where physical abuse.

Optional Accessories:

CATALOG NO.	UPC	DESCRIPTION	COMPATIBLE WITH	CARTONS	SHIP WT.
JWG46	685360138374	Wire Guard	JRK4	1	1 lbs
JWG57	685360138381	Wire Guard	JRK5	1	1.5 lbs

Dimensions and Clearances:

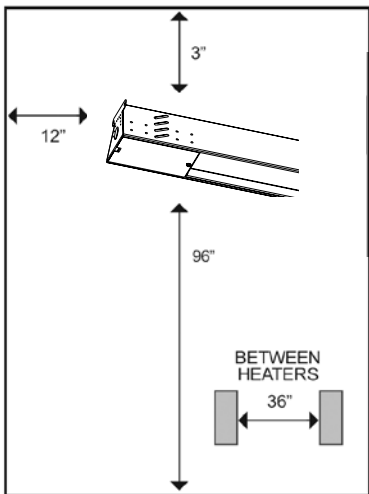

MOUNTING CLEARANCES

- 12 in. to vertical side walls
- 36 in. between heaters mounted side by side. Heaters may be mounted end to end.
- 3 in. to ceiling
- 96 in. to floor

XRM SERIES

Industrial Washdown Infrared Heater

RADIANT HEATERS

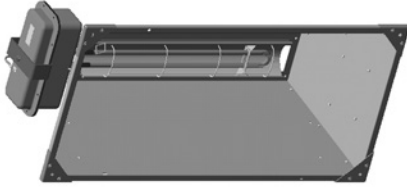

2.0 KW Fixed



4.5 KW Fixed

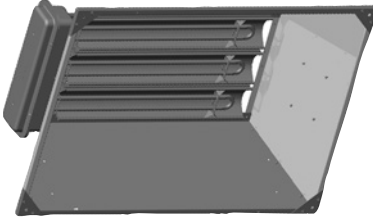

6.0 KW Fixed

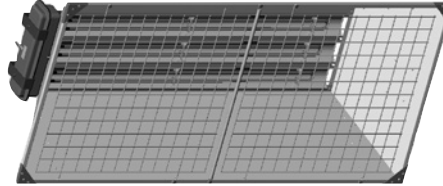

13.5 KW Fixed with Grille

Industrial stainless steel infrared heaters provide **fan-free warmth** in open areas like repair bays, walkways, assembly areas, foundries and loading docks.

Key Features:

High Output

The heavy duty U-bend heating element provides high wattage density, converting energy directly to heat at 100% efficiency at high efficiencies.

Wash-Down Capable

A sealed wiring compartment means you can wash down this unit safely and easily without worrying about moisture affecting its operation.

Rugged and Reliable

Designed for harsh industrial settings, these stainless steel heaters provide a durable source of heat. Optional safety grilles can be added for extra protection.

Technical Specifications:

Element Type: Metal Sheath

Reflection Angles: 90° Sym.

Ideal Spaces:

- Wastewater Treatment Plants
- Loading Docks
- Foundries
- Auto or Marine Repair Facilities
- Walkways
- Assembly Areas
- Enclosed Smoking Areas
- Indoor Storage Areas
- Covered Outdoor Storage Areas

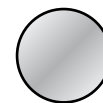

Stainless Steel



Scan the QR code to access additional specs and features.

Models & Specifications:

ITEM INFORMATION			ELECTRICAL DATA					SHIP WT.
CATALOG NO.	UPC	VOLTS	PHASE	WATTS	BTUs	AMPS		
● XRM4581	685360080635	208	1	4,500	15,354	21.6	18 lbs	
● XRM4521	685360080604	240	1	4,500	15,354	18.8	18 lbs	
● XRM4541	685360080611	480	1	4,500	15,354	9.4	18 lbs	
● XRM6083	685360080673	208	1 and 3	6,000	20,472	28.8	25 lbs	
● XRM6023	685360080642	240	1 and 3	6,000	20,472	25.0	25 lbs	
● XRM6043	685360080659	480	1 and 3	6,000	20,472	12.5	25 lbs	
■ XRM2081	685360105079	208	1	2,000	6,824	9.6	18 lbs	
■ XRM2021	685360105024	240	1	2,000	6,824	8.3	18 lbs	
■ XRM2041	685360105048	480	1	2,000	6,824	4.2	18 lbs	
■ XRM2061	685360105055	600	1	2,000	6,824	3.3	18 lbs	
■ XRM4561	685360105093	600	1	4,500	15,354	7.5	18 lbs	
■ XRM6071	685360105116	277	1	6,000	20,472	21.7	25 lbs	
■ XRM6063	685360080666	600	1 and 3	6,000	20,472	10.0	25 lbs	
■ XRM13583	685360152158	208	3	13,500	46,062	64.9	55 lbs	
■ XRM13523	685360152134	240	3	13,500	46,062	56.3	55 lbs	
■ XRM13571	685360105017	277	1	13,500	46,062	48.7	55 lbs	
■ XRM13543	685360080574	480	1 and 3	13,500	46,062	28.1	55 lbs	
■ XRM13563	685360080581	600	1 and 3	13,500	46,062	22.5	55 lbs	

SKU Legend: ● = Popular Products; ■ = Extended Offering (Contact your local Marley Sales Representative for typically associated lead times)

NOTE: Metal Sheathed: used indoors in high-traffic areas. Maintain at least 5 ft. in radiant path, between bottom of heater and combustible material. Pigtail element leads for a more positive connection in high-traffic areas where physical abuse. See following page for infrared accessories. Ground Fault Detection: Ground fault detection equipment is designed to monitor for any gradual changes in the insulation level due to humidity or mechanical damage as it develops, thus, de-energizing the load to prevent arcing type faults, preventing premature element failure and potential fire damage. As a safety precaution it is highly recommended that industrial infrared heaters must be protected by ground fault detection. Failure to comply could result in a building fire or serious equipment damage.

XRM SERIES

Industrial Washdown Infrared Heater

RADIANT HEATERS

Optional Accessories

Cord & Plug Kits For Industrial M Series Heaters

ITEM INFORMATION				ELECTRICAL DATA					SHIP WT.
CATALOG NO.	POWER CORDS	LOCKING	NON-LOCKING	kW	VOLTS	PHASE	AMPS	WIRE SIZE	
M4581B	CS25123	LPS25083	NPS25650	4.5	208	1	21.6	12/3	18 lbs
M4521B	CS25123	LPS25083	NPS25650	4.5	240	1	18.8	12/3	18 lbs
M4541B	CS25143	LPS25083	-	4.5	480	1	9.4	14/3	18 lbs
M4561B	CS25143	LPS25083	-	4.5	600	1	7.5	14/3	18 lbs
M6083B	CS25063	LPS25083	NPS25650	6	208	1	28.8	6/3	25 lbs
M6083B	CS25064	LPS25124	NPS1550	6	208	3	16.7	6/4	25 lbs
M6023B	CS25063	LPS25083	NPS25650	6	240	1	25.0	6/3	25 lbs
M6023B	CS25064	LPS25124	NPS1550	6	240	3	14.5	6/4	25 lbs
M6071B	CS25063	LPS25083	-	6	277	1	21.7	6/3	25 lbs
M6043B	CS25063	LPS25083	-	6	480	1	12.5	6/3	26 lbs
M6043B	CS25064	LPS25104	-	6	480	3	7.2	6/4	26 lbs
M6063B	CS25063	LPS25083	-	6	600	1	10.0	6/3	26 lbs
M6063B	CS25064	LPS25084	-	6	600	3	5.8	6/4	26 lbs
M13583B	CS25064	LPS25083	NPS1550	13.5	208	3	37.5	6/4	55 lbs
M13523B	CS25064	LPS25083	NPS1550	13.5	240	3	32.5	6/4	55 lbs
M13571B	CS25063	LPS25083	-	13.5	277	1	48.7	6/3	55 lbs
M13543B	CS25063	LPS25083	-	13.5	480	1	28.1	6/3	55 lbs
M13543B	CS25064	LPS25104	-	13.5	480	3	16.3	6/4	55 lbs
M13563B	CS25063	LPS25083	-	13.5	600	1	22.5	6/3	55 lbs
M13563B	CS25062	LPS25084	-	13.5	600	3	13.0	6/4	55 lbs

XRM Safety Grilles, Hanging Kits & Roll-Around Kits:

CATALOG NO.	UPC	DESCRIPTION	SHIP WT.
XRMWG2	685360143323	Safety Grille Kit for XRM 2KW Heaters	3 lbs
XRMWG45	685360143330	Safety Grille Kit for XRM 4.5KW Heaters	3 lbs
XRMWG60	685360143347	Safety Grille Kit for XRM 6KW Heaters	4 lbs
XRMWG135	685360143354	Safety Grille Kit for XRM 13.5KW Heaters	14 lbs
XRMHK	685360143361	Hanging Kit to mount XRM heaters, includes Chain and Hooks	2 lbs
XRM60	685360143385	Rollaround Cart Kit for 6.0KW XRM heaters (Includes Safety Grilles)	8 lbs
XRM135	685360143392	Rollaround Cart Kit for 13.5KW XRM heaters (Includes Safety Grilles)	8 lbs

Control Accessories for Industrial Infrared Heater:

CATALOG NO.	UPC	DESCRIPTION	kW MODELS	SHIP WT.
PDS60050	685360152332	Power Disconnect Kit for Fixed or Portable (M Series)	All	8 lbs
TOS240	685360151663	Tip-Over Switch for Fixed or Portable (M Series) 240V only	6 or 13.5	15 lbs
TOS480	685360151670	Tip-Over Switch for Fixed or Portable (M Series) 480V only	6 or 13.5	15 lbs
WMGF240	685360152349	Wall-Mounted Ground Fault Detection for 240V NEMA 4	All	17 lbs
WMGF277	685360174884	Wall Mounted Ground Fault Detection for 277V NEMA 4	All	17 lbs
WMGF480	685360152356	Wall-Mounted Ground Fault Detection for 480V NEMA 4	All	17 lbs
WMGF600	685360153087	Wall Mounted Ground Fault Detection for 600V NEMA 4	All	17 lbs

NOTE: All infrared accessories on this page are made to order (M). Contact your local Marley Sales Representative for typically associated lead times.

Personalized, controllable comfort exactly where it's desired

PORTABLE &
SPECIALTY HEATERS

Portable heaters deliver efficient heat with easy-to-control comfort settings and built-in safety features.



For personal heating at desks, tables, counters & other workstations, you need something safe, economical and easy to control.

Comfortable heat where you need it.



BSDH

QTS

MMHD

Their rugged, durable construction make them ideal for construction sites, garages, workshops and for cold office spaces and in bedrooms, family rooms and basements.

202SL SERIES

Radiant Plug-In Under Desk Heater

PORTABLE & SPECIALTY HEATERS



For **personal heating** you need something safe, economical and easy to control. This under desk heater meets these needs and more. Set it into place, flip the switch, and this unit **immediately puts out radiant warmth**, so it's perfect for close quarters.

Low cost of ownership and energy usage



*Usage costs estimates based on energy cost of 10 cents per kWh, 1 Day = 8 hrs., 1 Week = 5 Days and 1 Heat Season = 6 Months

Key Features:

Quiet, Unobtrusive Comfort

For personal heating that won't make noise or disrupt your space, choose an under desk heater. It fits in well at desk, table and counter areas in your family room, office or reception space.

Dual Installation Options

This heater is designed for freestanding operation, or it can be mounted to the wall to free up floor space.

Quick Setup

This heater offers radiant heat in a convenient package with its included power cord and three-prong plug. Just plug it in and you're ready to start heating.

Easy Operation

A lighted on/off switch makes it simple to turn the heat on or off, even in a dark room.

Ideal Spaces:

- Bedrooms
- Living/Family Room
- Kitchens
- Basements
- Offices
- Conference Rooms
- Lobbies
- Waiting Rooms

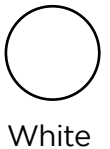

Models & Specifications:

ITEM INFORMATION		ELECTRICAL DATA			DIMENSIONAL DATA				
CATALOG NO.	UPC	VOLTS	WATTS	AMPS	HEIGHT	WIDTH	DEPTH	SHIP WT.	
◆ 202SLB	098319889652	120	170	1.4	14 3/8"	22 17/32"	1"	8 lbs.	
◆ MC202SLR	Master Carton (6 pcs)	120	170	1.4	16 1/4"	27 1/8"	13 1/2"	50 lbs.	

SKU Legend: ◆ = Popular Products; ● = Extended Offering (Contact your local Marley Sales Representative for typically associated lead times)
NOTE: Dimensions for Master Carton are shipping dimensions

Optional Accessories:

CATALOG NO.	UPC	DESCRIPTION
APT2	09831988964	Portable Thermostat



Scan the QR code to access additional specs and features.

WHT500 SERIES

Utility Well House Heater

PORTABLE & SPECIALTY HEATERS

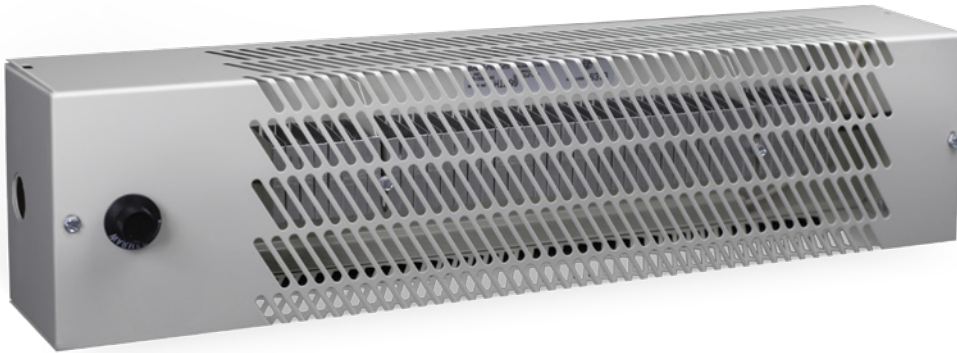

This utility heater provides **long-lasting protection** to keep sensitive equipment running strong. Install it in well houses, utility rooms, relay stations or other areas **where pipes and machinery are vulnerable to freezing.**

Key Features:

Guard Against Freezing

Protect pipes and other fluid-filled machinery from freezing damage with this utility heater. Its aluminum-finned element heats rapidly, and its steel sheath keeps the element cool for longer run time without maintenance.

Tamper-Resistant

Keep live voltage out of the element heating area. The heater features a tamper-resistant control box that contains the power supply and wiring for the unit.

Simple Temperature Management

Simply set the thermostat to your desired temperature with no need for further adjustments for 24-hour, worry-free heating.

Durable Design

Rely on this utility heater for freeze protection, even under rugged conditions. The unit is housed in a galvanized steel cabinet with a corrosion-resistant, epoxy-painted coating to endure seasonal changes and temperature swings.

Field Adaptable

The unit is easily field convertible to 120V, as the installation dictates.

Ideal Spaces:

- Wastewater Treatment Plants
- Pump Houses
- Utility Rooms
- Relay Stations
- Construction Sheds
- Cabins



Beige

Models & Specifications:

ITEM INFORMATION		ELECTRICAL DATA			SHIP WT.
CATALOG NO.	UPC	VOLTS	WATTS	AMPS	
◆ WHT500	68536008049	240/208/120	500/376/500	2.1/1.8/4.2	6 lbs

SKU Legend: ◆ = Popular Products; ● = Extended Offering (Contact your local Marley Sales Representative for typically associated lead times)



Scan the QR code to access additional specs and features.

MMHD SERIES

Portable Fan-Forced Utility Heater

PORTABLE &
SPECIALTY HEATERS



Whether you need extra warmth in your family room, basement or home office, this portable utility heater will suit your needs. **Just plug it in** and you are ready to go. The **built-in thermostat** allows you to set just the right temperature for quick comfort in any interior space.

Key Features:

A Rapid Solution

This portable electric heater offers efficient comfort. Its fan-forced design provides rapid output, so you can bring your room up to the desired temperature as soon as possible.

Increase Circulation

When you just want to clear the air, set this heater to fan-only mode. Fan only mode is also an excellent option when the room is already heated to your desired temperature.

Comfort Anywhere

The included grounded plug and 6-foot power cord allow you to move this heater from room to room for comfort that follows you throughout your day.

Easy Operation

The built-in thermostat allows for easy temperature management and control, so you can keep your space as comfortable as possible.

Two-Level Comfort

Two distinct heat settings allow you to heat both large and small spaces. You can quickly and easily double your output to bring more warmth to a wider area.

Ideal Spaces:

Bedrooms
Offices
Conference Rooms
Lobbies
Waiting Rooms

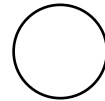

White

Models & Specifications:

ITEM INFORMATION		ELECTRICAL DATA			DIMENSIONAL DATA			
CATALOG NO.	UPC	VOLTS	WATTS	AMPS	HEIGHT	WIDTH	DEPTH	SHIP WT.
◆ MMHD1502T	098319861689	120	1500	12.5	14 ½	10 ½	6 ¾	9.2 lbs
		120	1300	10.8				

SKU Legend: ◆ = Popular Products; ● = Extended Offering (Contact your local Marley Sales Representative for typically associated lead times)



Scan the QR code to access
additional specs and features.

MCM SERIES

Portable Fan-Forced/Radiant Utility Heater

PORTABLE & SPECIALTY HEATERS



This portable utility heater easily switches between **fan-forced or radiant heat**. With varying heat levels and the option to go fanless, it is equally at home in the garage or workshop as it is in playrooms and bedrooms. Dual heating modes and three heat levels give you **precise control** over your comfort level.

Key Features:

Two Ways to Heat

This heater's unique design allows it to run in either fan-forced or radiant mode. So whether you want a quieter room, more air circulation or increased output, this is the most adaptable solution you can find in one convenient portable package.

Comfort Anywhere

The included grounded plug and 6-foot power cord allow you to move this heater from room to room for comfort that follows you throughout your day.

Triple Your Comfort

Three built-in heating levels allow you to adapt your settings for both large and small spaces. You can quickly and easily increase your output to bring more warmth to a wider area.

Heat for Where Life Happens

When you need extra warmth in your family room, basement, playroom or home office, choose this portable heater. Its dual operating modes and rugged design make it a fine choice for garages, workshops and construction sites as well.

Modern Design

A chrome grille offsets the white baked enamel finish on this heating unit, providing a contemporary accent that warms your home and looks good while doing it.

Ideal Spaces:

- Bedrooms
- Living/Family Room
- Kitchens
- Basements
- Offices
- Conference Rooms
- Lobbies
- Waiting Rooms
- Garages

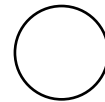

White

Models & Specifications:

ITEM INFORMATION		ELECTRICAL DATA				DIMENSIONAL DATA			
CATALOG NO.	UPC	VOLTS	WATTS	AMPS	BTU/HR	HEIGHT	WIDTH	DEPTH	SHIP WT.
◆ MCM1503	098319861665	120	1500	12.5	5120	14 1/2"	9 3/4"	7 1/2"	9 lbs
			900	7.5	3072				
			600	5	2048				

SKU Legend: ◆ = Popular Products; ● = Extended Offering (Contact your local Marley Sales Representative for typically associated lead times)



Scan the QR code to access additional specs and features.

NPH4A SERIES

Portable Unit Heater

PORTABLE & SPECIALTY HEATERS



When the temperature drops, bring in some extra warmth with a **heavy-duty** portable heater. With the option to go **freestanding** or **mounted** on the wall or ceiling, it fits perfectly in your garage, workshop or jobsite.

Key Features:

Bring the Heat

This portable electric heater brings heavy-duty fan-forced warmth wherever you need it. The built-in carry handles and 6-foot cord with 240V plug allow you to set up quickly and start heating right away.

Two-Level Comfort

Two distinct heat settings allow you to heat both large and small spaces. Set it to 9100 BTU per hour (2667 watts) or crank it up to 13650 BTU per hour (4000 watts) and bring more warmth to a wider area.

Set Up Anywhere

Portable design provides freestanding warmth wherever you need it. If you've got longterm heating needs, this heater can also be mounted to the wall or ceiling for space-saving convenience.

Warm While You Work

This portable heater delivers powerful, versatile heating for garages and other spaces like workshops or construction sites. Bring one along whenever your task takes you out into the cold.

Ideal Spaces:

Garage
Work Bench
Utility Room
Job Site

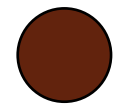

Bronze

Models & Specifications:

ITEM INFORMATION		ELECTRICAL DATA				DIMENSIONAL DATA			
CATALOG NO.	UPC	VOLTS	WATTS	AMPS	BTU/HR	HEIGHT	WIDTH	DEPTH	SHIP WT.
◆ QPH4A	098319861146	208	Low: 2667/2000	12.5/8.3/4.2	9102/9526	14"	16"	8"	25 lbs
		240	High: 4000/3000		13,652/10,239				

SKU Legend: ◆ = Popular Products; ● = Extended Offering (Contact your local Marley Sales Representative for typically associated lead times)



Scan the QR code to access additional specs and features.

BRH SERIES

Contractor Heater

PORTABLE & SPECIALTY HEATERS



Keep warm while you work **wherever the job takes you** with this heavy-duty portable construction heater. Its rugged, **low-maintenance design** and easy portability make it a welcome addition to your garage, workshop or jobsite.

Key Features:

Steel Performance

For maximum heat transfer, this model comes equipped with a metal sheathed heating element with a steel spiral fin.

Low Maintenance

For easy operation without the need for repeated maintenance, this heater features a permanently lubricated fan motor so it can keep running strong over the long haul.

Keep Objects Out

The industrial steel intake and discharge grille prevents foreign objects (or people's fingers) from reaching the heater's inner workings.

Safe Operation

The unit's high temperature limit prevents it from overheating, so you can leave the heat on even when you're not present.

Complete Control

This portable construction heater comes equipped with a built-in double-pole thermostat with a positive off switch, so you can be sure it's off before you leave the room.

Ideal Spaces:

- Garage
- Work Bench
- Utility Room
- Job Site

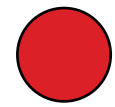

Red

Models & Specifications:

ITEM INFORMATION			ELECTRICAL DATA				DIMENSIONAL DATA			
CATALOG NO.	UPC	VOLTS	WATTS	AMPS	BTU/HR	HEIGHT	WIDTH	DEPTH	SHIP WT.	
◆ BRH402	098319862006	240/208	4000/3000	16.7/14.1	13,650/10,238	11"	10 ½"	9 ¾"	17 lbs	
◆ BRH562*	098319862020	240/208	5600/4200	23.3/20.2	19,110/14,333	12"	11 ¾"	10 ¾"	19 lbs	

SKU Legend: ◆ = Popular Products; ● = Extended Offering (Contact your local Marley Sales Representative for typically associated lead times)
 NOTE: Includes fan-only function. Plug type for BRH402 is 20 Amp, 240V NEMA #6-20P. Plug type for BRH562 is 30 Amp, 240V NEMA #6-30P.



Scan the QR code to access additional specs and features.

FHP SERIES

Portable Electric Hydronic Heater

PORTABLE & SPECIALTY HEATERS



This hydronic baseboard heater provides **long-lasting comfort** on cold nights. This 120-volt, plug-in portable baseboard model uses liquid-element technology to provide **warm, gentle heat** at a lower surface temperature, so it's safe to use around pets and small children. This UL-listed hydronic heater **prevents overheating**, thanks to its thermal cutoff switch.

Key Features:

Use Right Out of the Box

Start heating immediately. This portable hydronic baseboard heater comes equipped with a standard 120-volt plug, so you can quickly add it to any room that needs extra warmth.

Cooler to the Touch

This baseboard model provides worry-free heating around pets and kids thanks to its hydronic design.

Never Hear a Ping

This convection heater starts up and stops without the disruptive popping or pinging sounds given off by traditional baseboard models.

Circulate Heat, Not Debris

Keep dust and other particles from circulating, thanks to this hydronic baseboard heater's fanless operation. With no blower or exhaust fan, allergens and dander won't be blowing around the room.

Optimum Efficiency

Keep the room comfortable and reduce unnecessary on/off cycles with up to 100% energy-efficient design.

Ideal Spaces:

- Bedrooms
- Living/Family Room
- Kitchens
- Basements
- Offices
- Conference Rooms
- Lobbies
- Waiting Rooms

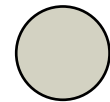

Navajo White

Models & Specifications:

ITEM INFORMATION		ELECTRICAL DATA				DIMENSIONAL DATA			
CATALOG NO.	UPC	VOLTS	WATTS	AMPS	BTU/HR	HEIGHT	WIDTH	DEPTH	SHIP WT.
◆ FHP1500T	68536016078	120	1500	12.5	5120	8 27/64"	58"	5 29/32"	19 lbs

SKU Legend: ◆ = Popular Products; ● = Extended Offering (Contact your local Marley Sales Representative for typically associated lead times)



Scan the QR code to access additional specs and features.

FBE SERIES

Portable Electric Convectector Heater

PORTABLE & SPECIALTY HEATERS



For **uniform heat** in any room. The Portable Electric Convectector Heater's variable wattage element provides comfort from floor to ceiling, without hot or cold spots, using **natural convection currents** to move warm air instead of a fan or blower. The unit's 120-volt plug allows you to use it in almost any room, and the built-in thermostat provides effective control. Its **low-profile design** means you can tuck it away without worrying about overheating, thanks to its **automatic thermal cutoff** function.

Key Features:

Use Right Out of the Box

Start heating immediately. This portable baseboard heater comes equipped with a standard 120-volt plug, so you can quickly add it to any room for extra warmth.

Circulate Heat, Not Debris

Keep dust and other particles from circulating, thanks to this hydronic baseboard heater's fanless operation. With no blower or exhaust fan, allergens and dander won't be blowing around the room.

Optimum Efficiency

For maximum efficiency, the unit converts all incoming electric energy into heat, according to Department of Energy standards.

Safe Operation

For worry-free warmth, the unit's overheat protection feature prevents the heater from running when its air intake is blocked.

Keep Cozy

This baseboard heater installs unobtrusively in bedrooms, bathrooms, living rooms and dens, thanks to its low-profile design.

Ideal Spaces:

- Bedrooms
- Living/Family Room
- Kitchens
- Basements
- Offices
- Conference Rooms
- Lobbies
- Waiting Rooms

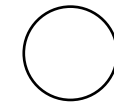

White

Models & Specifications:

ITEM INFORMATION		ELECTRICAL DATA				DIMENSIONAL DATA			
CATALOG NO.	UPC	VOLTS	WATTS	AMPS	BTU/HR	HEIGHT	WIDTH	DEPTH	SHIP WT.
◆ FBE15002	098319861566	120	1000	8.4	3414	7 1/2"	45"	5 3/8"	11 lbs

SKU Legend: ◆ = Popular Products; ● = Extended Offering (Contact your local Marley Sales Representative for typically associated lead times)



Scan the QR code to access additional specs and features.

QTS SERIES

Toe Space Fan-Forced Heater

PORTABLE & SPECIALTY HEATERS



This electric toe kick heater installs under cabinets in kitchens, bathrooms, stairwells and more — providing **floor-level warmth** whenever you need it. Get quiet, even heat in a **slim design** that saves wall and floor space.

Key Features:

Hushed Heating

Keep warm without the noise, thanks to a compact, cross-flow blower that limits sound output while still delivering plenty of power.

Complete Control

Easily set your desired temperature with a remote wall-mounted thermostat or a built-in thermostat (select models only).

Heat Evenly

The steel-plate finned heating element is arranged in a uniform grid pattern for even heating and no wasted energy

Models & Specifications:

ITEM INFORMATION			ELECTRICAL DATA			SHIP WT.
CATALOG NO.	UPC	VOLTS	WATTS	AMPS		
◆ QTS1100*	685360065380	120	1125/563	9.4/4.7	10 lbs	
◆ QTS1104*	685360065397	240	1125/563	4.7/2.3	10 lb	
		208	844/422	4.1/2.0		
◆ QTS1500T**	685360065410	120	1500/750	12.5/6.3	11 lbs	
◆ QTS1504T**	685360065434	240/208	1500/750	6.3/3.1	11 lbs	
			1125/564	5.4/2.7		

SKU Legend: ◆ = Popular Products; ● = Extended Offering (Contact your local Marley Sales Representative for typically associated lead times)
 *Models require QTSTSP or remote wall-mounted thermostat. **Models shipped with single-pole thermostat installed. Add NW to catalog number for White (ex. QTS1100NW).

Optional Accessories:

CATALOG NO.	UPC	DESCRIPTION	SHIP WT.
QTSAG	685360065328	Adapter Grille 3 1/2" H x 23 3/8" W	1 lbs
QTSTSP	685360065335	120-240V Thermostat Kit	1 lbs

Technical Specifications:

Temp Range: 45°-85°F

Ideal Spaces:

- Kitchens
- Bathrooms
- Offices
- Small stairwells
- Small waiting rooms

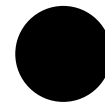

Black

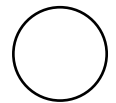

White



Scan the QR code to access additional specs and features.

FDI SERIES

Floor Drop-In Heater

PORTABLE & SPECIALTY HEATERS



For ground level comfort, choose a drop-in unit heater. These units are specifically designed to be placed into flooring for an **unobtrusive heating solution** that keeps building occupants warm without taking up extra space.

Key Features:

Minimize Disruption

Drop-in heaters operate quietly, so you can keep bedrooms, living rooms and offices warm without distracting fan noise.

Safe Operation

These drop-in heaters come equipped with standard overheat protection for longterm peace of mind. The unit shuts down if it gets too hot, preventing unsafe conditions.

Ready to Connect

Included push-on tabs allow the wiring terminals of this heater to connect with ease for rapid installation and easy maintenance, even for multiple heating units.

Durability by Design

The heavy duty steel grille features a baked enamel finish for extra protection from scuffs, scratches and environmental corrosion.

Technical Specifications:

Temp Range: 55°–90°F
CFM: 80

Ideal Spaces:

Vestibules & Hallways
Bathrooms & Bedrooms



Models & Specifications:

ITEM INFORMATION		ELECTRICAL DATA				SHIP WT.
CATALOG NO.	UPC	CFM	VOLTS	WATTS	AMPS	
◆ FDI1500	685360026268	80	120	1500/750	12.5/6.3	10 lbs
◆ FDI1504	685360026282	80	240	1500/750	6.3/3.1	10 lbs
		80	208	1125/563	5.4/2.7	

SKU Legend: ◆ = Popular Products; ● = Extended Offering (Contact your local Marley Sales Representative for typically associated lead times)

NOTE: 60 hz, single-phase. Do not install in bathroom or other areas where water may enter heater unit. Do not locate where air flow may be obstructed (under drapes, behind doors, etc.). Keep short side 36 in. min. and long side 3 in. min. from side walls. Do not install in ceiling or wall.

Optional Accessories:

CATALOG NO.	UPC	DESCRIPTION	SHIP WT.
FDITSP	685360026190	120-240V Thermostat Kit	1



Scan the QR code to access additional specs and features.

BDH SERIES

Portable Dragon Heater

PORTABLE & SPECIALTY HEATERS



Product is ready to use right out of the box and has been newly redesigned to be more **sleek and compact**. Provides high heat output while maintaining the ability to be **moved wherever you need it**.

Key Features:

Always Ready To Go

Compact design with robust air filled tires and included plug and cord kit make this heater easy to use right out of the box.

Quick and Easy Setup

Redesigned control compartment adds more space and easy access to internals for fast installation and maintenance.

Safer than the Competition

Can be left unattended without threat of poisoning from combustion by-products associated with fuel-fired heaters. Fan only mode allows for air recirculation, fume exhaust or fresh air supply.

Flexible Comfort Control

Designed with built-in thermostat and safety thermal cutout, thermostat selector switch, and optional ceiling/wall bracket to heat exactly how you need.

Ideal Spaces:

Construction Sites
Food Processing
Textile Mills & Paper Mills
Printing Plants & Chemical Plants
Truck Docks
Marinas

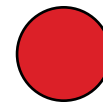

Red



Scan the QR code to access
additional specs and features.

BDH SERIES

Portable Dragon Heater

PORTABLE &
SPECIALTY HEATERS

Models & Specifications:

ITEM INFORMATION			ELECTRICAL DATA					DIMENSIONAL DATA			
CATALOG NO.	UPC		VOLTS	PHASE	KW	BTU/HR	AMPS	HEIGHT	WIDTH	DEPTH	SHIP WT.
● BDH1583CKD	685360171807		208	3	15	51,180	41.8	40"	30"	24"	65 lbs
● BDH1543CKD	685360171814		480	3	15	51,180	18.6	40"	30"	24"	65 lbs
● BDH3043D	685360152271		480	3	30	102,360	36.3	40"	30"	24"	75 lbs
● BDH1021CKD	685360152585		240	1	10	34,120	41.7	40"	30"	24"	65 lbs
● BDH1521D	685360152196		240	1	15	51,180	62.5	40"	30"	24"	65 lbs
● BDH1523D	685360152219		240	3	15	51,180	36.3	40"	30"	24"	65 lbs

SKU Legend: ● = Popular Products; ● = Extended Offering (Contact your local Marley Sales Representative for typically associated lead times)

Optional Accessories:

CATALOG NO.	UPC	KW	DESCRIPTION	SHIP WT.
DHCWM	685360152127	-	Ceiling and wall bracket can be used on all models	20 lbs
SCS25043	685360152516	4/3 SO	DH1521A	22 lbs
SCS10063	685360152509	6/3 SO	DH1021A (10ft long w/plug)	18 lbs
SCS25064	685360152523	6/4 SO	DH1583A, DH1523A, DH3043A	20 lbs
SCS25124	685360152530	12/4 SO	DH1543A	10 lbs

Optional Cord & Plug Kits:

CATALOG NO.	kW	VOLTS	PHASE	AMPS	WIRE SIZE	25 FOOT CORD	LOCKING	NON-LOCKING	SHIP WT.
BDH1021A	10	240	1	39.6	6/3	SCS10063 (10ft.)	-	Included	18 lbs
BDH1583A	15	208	3	41.8	6/4	SCS25064	LPS25064	-	20 lbs
BDH1521A	15	240	1	62.5	4/3	SCS25043	-	-	22 lbs
BDH1523A	15	240	3	36.3	6/4	SCS25064	LPS25064	NPS1550	20 lbs
BDH1543A	15	480	1	31.2	6/4	SCS25064	LPS25064	NPS1550	20 lbs
			3	18.1	12/4	SCS25124	LPS25104	-	10 lbs
BDH3043A	30	480	3	36.3	6/4	SCS25064	-	-	20 lbs

NOTE: Models designated 1 and 3 phase can be field-wired for single-phase operation.

BSDH SERIES

High-Temp Dragon Heater

PORTABLE & SPECIALTY HEATERS



Most powerful portable electric heater around. This heater is designed for when you need a lot of **heat fast** without the need for refueling.

Key Features:

Heavy Duty Heat

High BTU per hour output, powder-coated, corrosion-resistant 20-gauge steel housing, 10 in. pneumatic wheels, and a 4 in. locking caster make for a robust and long lasting heater you can take anywhere.

Heat Where you Need It

Adjustable damper accessory controls outlet temperature, 1 HP motor with adjustable pulleys allowing for adjustable fan speeds, and inlet and outlet flexible duct accessories available for ducting up to 165 ft.

Quick and Easy Setup

Control compartment on outside of unit allows for easy access to internals and fast installation and maintenance.

Safer than the Competition

Can be left unattended without threat of poisoning from combustion by-products associated with fuel-fired heaters. Fan only mode allows for air recirculation, fume exhaust or fresh air supply.

Ideal Spaces:

Construction Sites
Food Processing
Textile Mills & Paper Mills
Printing Plants & Chemical Plants
Truck Docks
Marinas

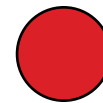

Red



**Scan the QR code to access
additional specs and features.**

BSDH SERIES

High-Temp Dragon Heater

PORTABLE &
SPECIALTY HEATERS

Models & Specifications:

ITEM INFORMATION			ELECTRICAL DATA				DIMENSIONAL DATA			
CATALOG NO.	UPC		VOLTS (3-PHASE)	KW	BTU/HR	AMPS	HEIGHT	WIDTH	DEPTH	SHIP WT.
● BSDH3043	685360149127		480	30	102,363	37.2	44"	25.4"	38.5"	150 lbs
● BSDH3093	685360149158		600	30	102,363	30	44"	25.4"	38.5"	150 lbs
● BSDH4843	685360149165		480	48	163,781	58.9	44"	25.4"	38.5"	160 lbs
● BSDH4893	685360149196		600	48	163,781	47.3	44"	25.4"	38.5"	170 lbs
● BSDH6043	685360149202		480	60	204,727	73.3	44"	25.4"	38.5"	170 lbs
● BSDH6093	685360149233		600	60	204,727	58.9	44"	25.4"	38.5"	170 lbs

SKU Legend: ◆ = Popular Products; ● = Extended Offering (Contact your local Marley Sales Representative for typically associated lead times)

Optional Accessories:

CATALOG NO.	UPC	DESCRIPTION	SHIP WT.
BSDHFX20	685360150734	20 in. Diameter Flexible Duct (25 feet)	45 lbs
BSDHDA20	685360150772	20 in. Diameter Adaptor Ring	20 lbs
BSDHSK20	685360150758	20 in. Diameter Splice Kit	40 lbs
BSDHDC	685360150796	20 in. Diameter Duct Clamp	3 lbs
BSDHAD	685360150819	Adjustable Damper	12 lbs

Cut heating & cooling bills by as much as 30%*

Looking to keep it cool in a gymnasium, factory, outdoor mall or industrial building? Look no further than our ceiling fans.



With a durable, contoured blade design, these fans are built for temperature control. Industrial and commercial ceiling fans provide an economic solution for keeping air moving.



IHD SERIES

Industrial High-Efficiency Ceiling Fans

CEILING FANS

18 Pole 115V; motor. Permanently sealed double-ball bearing motor. 3/8" X 7 1/4" locking J-hook for installation White epoxy finish (unless noted otherwise). Steel blades. Designed for winter heat destratification and summer cooling. Supplied with 24" downrod.

Models & Specifications:

	CATALOG NO.		UPC	FAN TYPE	VOLTAGE	FAN SIZE (WIDTH)	CFM/WATTS	CFM	WATTS	EYEC**
	FAN & CONTROLLER KIT	FAN ONLY								
◆	56001HPK	56001HP	685360174464	High Performance Industrial	120	56"	102	6561	64.3	\$18.00
◆	56001BRNHPK	56001HP-BRN	685360174488		120	56"	102	6561	64.3	\$18.00
◆	56007HPK	56007HP	685360174563		277	56"	85.3	8959	105	\$20.00
◆	60001HPK	60001HP	685360174501		120	60"	86.5	6090	70.4	\$18.00
◆	60001BRNHPK	60001HP-BRN	685360174525		120	60"	86.5	6090	70.4	\$18.00

SKU Legend: ◆ = Popular Products; ● = Extended Offering

(Contact your local Marley Sales Representative for typically associated lead times)

All products with the suffix "K" include a speed control. 12003 is used for 120V applications and 27708 is used for 277V applications. All above products include 24" downrod.

*Effective amount of air volume moved past a plane 20ft. from fan. All specifications subject to change and improvement.

CATALOG NO.	DESCRIPTION	SHIP WT.
◆ 9B24BW	Downrod 24"—White	2 lbs
◆ 9B24BB	Downrod 24"—Brown	2 lbs
◆ 9D08	Downrod 8"—White	1 lbs

Secondary Control Options for New Construction Applications:

CATALOG NO.	DESCRIPTION	VOLTAGE	AMPERAGE	SHIP WT.	QTY OF FANS CONTROLLED PER MODEL #			
					36201C	48201C	56001LCC	56201CLS
◆ 12003	Speed Control	120	3	2 lbs	3	2	2	2
◆ 12006	Speed Control	120	6	2 lbs	7	5	5	5
◆ 12008	Speed Control	120	8	2 lbs	10	6	6	6
◆ 12012	Speed Control	120	12	2 lbs	12	10	10	10
◆ 12001N	Speed Control, Noiseless	120	1	2 lbs	—	1	—	—
◆ 12005N	Speed Control, Noiseless	120	5	2 lbs	—	2	2	—

Before purchasing this appliance, read important information about its estimated annual energy consumption, yearly operating cost, or energy efficiency rating that is available from your retailer at MarleyMEP.com/Resource-Library

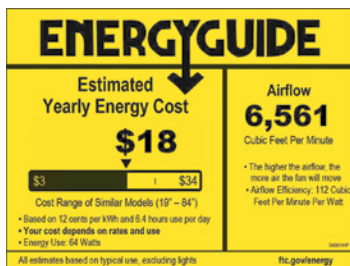

56001HP

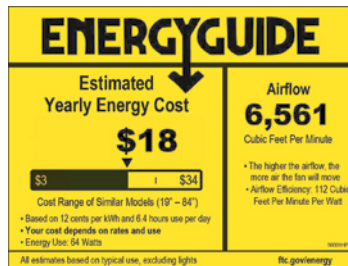

60001HP

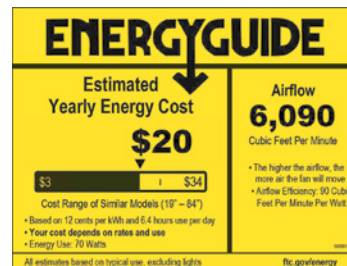

56007HP



Scan the QR code to access additional specs and features.



CHD SERIES

CEILING FANS

Commercial High-Efficiency Ceiling Fan

18 Pole 115V; reversible motor. Permanently sealed double-ball bearing motor. 3/8" x 7 1/4" locking J-hook for installation. White epoxy finish. Steel blades. Provides superior air velocity and efficiency.

Models & Specifications:

	CATALOG NO.		FAN TYPE	VOLTAGE	FAN SIZE (WIDTH)	CFM/WATTS	CFM	WATTS	EYEC**
	FAN & CONTROLLER KIT	FAN ONLY							
◆	36201K	36201C	High Efficiency	120	36"	64.0	2126	33.2	\$9.30
◆	48201K	48201C	High Efficiency	120	48"	85.6	3861	45.1	\$12.60
◆	56001LCK*	56001LCC*	High Efficiency/Low Ceilings	120	56"	87.8	4952	56.4	\$15.80
◆	56201CLSK*	56201CLS*	High Efficiency/Low Speed	120	56"	81.0	5436	67.1	\$18.80

SKU Legend: ◆ = Popular Products; ● = Extended Offering

Note: All above products include 24" downrod. * Effective amount of air volume moved past a plane 20ft. from fan. All specifications subject to change and improvement. ** Estimated Yearly Energy Cost based on ENERGY GUIDE standards

Optional Accessories:

CATALOG NO	DESCRIPTION	SHIP WT.
9B24BW	Downrod 24"—White	2 lbs
9B24BB	Downrod 24"—Brown	2 lbs
9D08	Downrod 8"—White	1 lbs
CTL12004RSPD	Controller—Reversible & Speed Control, 4 Fans, 120v	1 lbs

Secondary Control Options for New Construction Applications:

CATALOG NO	DESCRIPTION	VOLTAGE	AMPERAGE	SHIP WT.	Model Fan and Quantity per Control			
					36201C	48201C	56001LCC	56201CLS
12003	Speed Control	120	3	2 lbs	3	2	2	2
12006	Speed Control	120	6	2 lbs	7	5	5	5
12008	Speed Control	120	8	2 lbs	10	6	6	6
12012	Speed Control	120	12	2 lbs	12	10	10	10
12001N	Speed Control, Noiseless	120	1	2 lbs	—	1	—	—
12005N	Speed Control, Noiseless	120	5	2 lbs	—	2	2	—

*6 fans on 277V. **56 in. models excludes 56007

NOTE: Choosing a secondary control removes the ability for fan to be used in reverse. If speed control and reversibility are needed please use the CTL12004RSPD



Control your comfort with easy-to-use features and money-saving controls

THERMOSTATS & CONTROLS

Wall thermostats are a snap to install and easy to program for convenient and smart energy savings.

M601W / M602W

Best Sellers | Easy Installation and Control | Great Low Cost Solution



MD26



CNTLTSTDNP1H1C

*Advanced Comfort Control
Sleek and Modern Design
Accurate Low Voltage Solution*



LTR2240

*Direct Low Voltage Control for High Amp Loads
Allows for BMS Integration
Microprocessor Base Design*



SMARTSERIES® PLUS

Digital Touchscreen Control

THERMOSTATS & CONTROLS



SmartSeries Plus is the first digital touchscreen control capable of running a **fully programmable internal schedule** as well as having the capability to **connect to a BACnet Building Management System**.

Key Features:

Intelligent Controls for Intelligent Buildings

This control comes ready to connect to your Building Management System using BACnet MS/TP protocol.

Reduced Operations & Maintenance Time

BMS saves facility manager time and personnel cost by eliminating the need to travel to the heater site and inspect and diagnose root cause.

Control at your Fingertips

Without a BMS you can still get heat when and where you need it by using the built in 7 day programmable scheduling feature. With the Occupancy Settings, you can quickly schedule different temperatures for multiple periods per day.

Lockable Key Pad

Protects the unit from unauthorized access and/or tampering giving you peace of mind the heater is running correctly.

Temperature Override

Control your comfort even further by allowing users to set a temperature above programmed setpoints for up to 4 hours in an unoccupied state.



Scan the QR code to access additional specs and features.

Featured Compatible Products



HUHAA & HUHAA-PRO



CUHS900

Product Compatibility Matrix

THERMOSTATS & CONTROLS

		2500 ¹	BKOC ¹	HBB	COS-E ⁴	SED	GFR	QTS ⁶	FFCH ⁷	QFF ⁷	QCH ⁷	HUHAA ⁸	HUH ⁸	CUHS900	BPH	CONVECTORS ⁸	RCC	CP	VRP	VRS	OTHER RADIANT	
Electronic Digital Line Voltage	TL823 OA1003/U	+	+	+	▲		▲		▲	▲	▲					☒	+	+	☒	☒	☒	
	TH108PLUSA	+	+	+	▲		▲		▲	▲	▲					☒	+	+	☒	☒	☒	
	TH106A	+	+	+	▲		▲		▲	▲	▲					☒	+	+	☒	☒	☒	
	TH114A240DBA	+	+	+	▲		▲		▲	▲	▲					☒	+	+	☒	☒	☒	
Electronic Digital Low Voltage ⁵	CNTLTSTDNPIHIC	+	+	+										+								
	CNTLSSPBMS											+		+								
	TH5220D1003				▲		▲		▲	▲	▲				+	☒			☒	☒	☒	
Mechanical: Manual Temperature Control	MS26	+	+	+	▲		▲	+	▲	▲	▲	☒	☒			☒	+	+	☒	☒	☒	
	MD26	+	+	+	▲		▲	+	▲	▲	▲	☒	☒			☒	+	+	☒	☒	☒	
	M601W	+	+	+	▲		▲	+	▲	▲	▲	☒	☒	+		☒	+	+	☒	☒	☒	
	M601TPW	+	+	+	▲		▲	+	▲	▲	▲	☒	☒	+		☒	+	+	☒	☒	☒	
	M602W	+	+	+	▲		▲	+	▲	▲	▲	☒	☒			☒	+	+	☒	☒	☒	
	M602TPW	+	+	+	▲		▲	+	▲	▲	▲	☒	☒			☒	+	+	☒	☒	☒	
	M611W	+	+	+	▲		▲	+	▲	▲	▲	☒	☒	+		☒	+	+	☒	☒	☒	
	M612W	+	+	+	▲		▲	+	▲	▲	▲	☒	☒			☒	+	+	☒	☒	☒	
	M600S*																					
	M600MTP*																					
	T100	+	+	+	▲		▲	+	▲	▲	▲	☒	☒	+		☒	+	+	☒	☒	☒	
	T200	+	+	+	▲		▲	+	▲	▲	▲	☒	☒			☒	+	+	☒	☒	☒	
	WR661	+	+	+	▲		▲	+	▲	▲	▲	☒	☒			☒	+	+	☒	☒	☒	
Commercial/ Industrial	WT11A								+	+	+	☒	☒	+		☒		+	☒	☒	☒	
	WT12A											☒	☒	+		☒		+	☒	☒	☒	
	WR80	+	+	+					+	+	+	☒	☒	+		☒	+	+	☒	☒	☒	
	JC80EP											☒	☒			☒			☒	☒	☒	

1 Electronic thermostats have amperage minimums and each model has different voltage requirements, please check catalog thermostat specifications.

4 Series models require the removal of the internal thermostat from unit. Wire wall thermostat for proper fan operation. See model selection for specific thermostats.

5 Low voltage thermostats operate in conjunction with low voltage control systems using relays. Compatible with all standard 24V two wire thermostats.

6 The QTS watt units can use either single-pole or double-pole thermostats. The 1500 watt units must use a double-pole thermostat. (three conductors from thermostat to unit). Does not apply to low voltage thermostats, which need a transformer.

7 CDF and EFF Series models require different thermostats based on internal wiring. Wire wall thermostat for proper fan operation. See model selection for specific thermostats. Can not use digital thermostats with this unit.

8 Due to the complexity of wiring variations for remote wall thermostats with these products, we recommend that you contact Technical Services for assistance.

SKU Compatibility Chart

THERMOSTATS & CONTROLS

HEATER	THERMOSTAT
GFR1500F	TH106A, M601W, M611W, T100, WR651
GFR2004F	TL8230A1003/U, TH106A, TH108PLUSA, M602W, M612W, T200, WR661
GFR2404F	TL8230A1003/U, TH106A, TH108PLUSA, M602W, M612W, T200, WR661
GFR1500T2F	TH106A, M601W, M611W, T100, WR651
GFR2004T2F	TL8230A1003/U, TH106A, TH108PLUSA, M602W, M612W, T200, WR661
GFR2404T2F	TL8230A1003/U, TH106A, TH108PLUSA, M602W, M612W, T200, WR661
CZ1512T	TH106A, M601W, M611W, T100, WR651
CZ1012T	TH106A, M601W, M611W, T100, WR651
CZ1048T	TH106A, M601W, M611W, T100, WR651
CZ1548T	TH106A, M601W, M611W, T100, WR651
CZ2048T	TH106A, M601W, M611W, T100, WR651
FFCH548	MS26, M601W
FFCH542	MS26, M601W
FFCH547	MS26, M601W
FFCH558	MS26, M601W
FFCH552	MS26, M601W
FFCH557	MS26, M601W
QFF1500	MS26, M601W
QFF3007	MS26, M601W
QFF4008	MS26, M601W
QFF4004	MS26, M601W
QFF4007	MS26, M601W
QFF4804	MS26, M601W
QFF4807	MS26, M601W
QFF3003	-
QFF3006	-
QFF4003	-
QFF4006	-
QFF4803	-
QFF4806	-
QFF48483	-
QFF48483LV	-
QCH1101F	M601W, MS26
QCH1151F	M601W, MS26
QCH1202F	M601W, MS26
QCH1207F	M601W, MS26

NOTE: Programmable thermostats cannot be used with the models listed above.

Thermostats

Electronic Digital Line Voltage

THERMOSTATS & CONTROLS



	TH108PLUSA	TH114A240DBA	TH106A	TL8230A1003/U	YTL9160AR1000OW
Action	Triac: Silent Operation	Electronic Switch	Triac: Silent Operation	Microprocessor	Microprocessor
Type	12.5A Resistive 2-wire SPST	15 A Resistive 4-wire DPST	16.7A Resistive 2-wire SPST	16.7 A Resistive 4-wire DPST	12.5A Resistive 2-wire SPST
Watt Rating	Minimum: 2-amp load	No minimum load	Minimum: 2-amp load	No minimum load	Minimum: 0.4-amp load
120v	n/a	n/a	2000 watts	n/a	1500 watts
208v	n/a	n/a	n/a	3120 watts	2600 watts
240v	3000 watts	3600 watts	4000 watts	3600 watts	3000 watts
277v	n/a	n/a	n/a	n/a	n/a
Pilot Duty	No	No	No	No	No
Temp. Range (°F)	40°F to 85°F	40°F to 85°F	40°F to 85°F	40°F to 85°F	40°F to 85°F
Differential	Accuracy: Within +/- 0.27°F	Accuracy: Within 1°F of setpoint	Accuracy: Within +/- 0.27°F	Accuracy: Within 1°F of setpoint	Accuracy: Within +/- 1°F
Features	Digital, non-programmable 12.5amp model delivers exceptional accuracy. Ideal for radiant ceiling panels and baseboard. Not for fan-forced heaters.	Digital, non-programmable model delivers exceptional accuracy. Ideal for radiant ceiling panels and baseboard. Can be used for fan-forced heaters.	Digital, programmable high capacity model delivers exceptional accuracy. Ideal for radiant ceiling panels and baseboard. Can be used for fan-forced heaters and resistive loads.	Digital, programmable model delivers exceptional accuracy. Ideal for radiant ceiling panels and baseboard. Can be used for fan-forced heaters.	Wireless, digital and programmable model delivers exceptional accuracy. Ideal for radiant ceiling panels and baseboard. Can be used for fan-forced heaters.



Electronic Digital Low Voltage



	CNTLTSTDNPIHIC	CNTLSSPBMS	TH5220D1003
Action	Electronic Switch	Electronic Switch	Electronic Switch
Type	24V .015 -1.0A @ 30V 2-wire	24V .015 -1.0A @ 30V 2-wire	24V .015 -1.0A @ 30V 5-wire
Watt Rating	-	-	-
120v	n/a	n/a	n/a
208v	n/a	n/a	n/a
240v	n/a	n/a	n/a
277v	n/a	n/a	n/a
Pilot Duty	24VAC	24VAC	24VAC
Temp. Range (°F)	40°F to 90°F	40°F to 90°F	40°F to 90°F
Differential	Accuracy: Within 1°F of setpoint	Accuracy: Within 1°F of setpoint	Accuracy: Within 1°F of set
Features	Digital, non-programmable 24V delivers exceptional accuracy. (Heat Only)	Digital touchscreen two stage thermostat runs 2/3 elements on stage 1 and full heat for stage 2. Comes with BACnet MS/TP BMS compatibility, 7 day scheduling, cooling mode (Fan-Only), temporary override, vacation mode, and keypad lock.	Digital, 24V 2-stage 5-7 wire heat and cool thermostat. One-touch temperature control with exceptional accuracy. Ideal for plenum heaters, and HVAC systems.

Thermostats Line Voltage

THERMOSTATS & CONTROLS



	MS26	MD26	M601W	M602W	M601TPW	M602TPW	M611W	M612W
Action	Snap Action		Snap Action		Snap Action		Snap Action	
Type	SPST	DPST	SPST	DPST	SPST	DPST	SPST	DPST
Watt Rating	Model MD26 has Positive OFF		Model M602W has Positive OFF		Model M602TPW has Positive OFF		Model M612W has Positive OFF	
120v	22A		22A		22A		22A	
208v	22A		22A		22A		22A	
240v	22A		22A		22A		22A	
277v	18A		18A		18A		18A	
Pilot Duty	No		Yes 125VA		Yes 125VA		Yes 125VA	
Temp. Range (°F)	50°F to 80°F		45°F to 75°F		45°F to 75°F		45°F to 75°F	
Differential	+/- 5°F		+/- 4°F		+/- 4°F		+/- 2 ½°F	
Features	These economy thermostats are the snap action type that are used in apartment construction. Good thermostat for its value. Ideal for radiant cove heaters and baseboard.		These bi-metal snap-action thermostats are sensitive. Large knob allow for easy adjustment.		Same as M601W and M602W except the cover mounting cover offer tamper-proof feature.		Built-in heat anticipator assures closer control of room temperature.	



	M600MTP	M600S	T100	T200
Action	Modulation (2-stage)	Simultaneous switching (double ckt)	Snap Action with Heat Anticipator	
Type	DPST		SPST	DPST
Watt Rating				
120v	22A	22A	22A	
208v	22A	22A	22A	
240v	22A	22A	22A	
277v	18A	18A	18A	
Pilot Duty	Yes 125VA	Yes 125VA	Yes 125VA	
Temp. Range (°F)	45°F to 75°F	50°F to 80°F	50°F to 90°F	
Differential	Accuracy: Within 3°F of setpoint	Accuracy: Within 3°F of setpoint	+/- 2 ½°F	
Features	One thermostat controls two separate heating circuits and reduces input during light load periods. Second stage activates when temperature drops to approx. 1-1/2°F below the first stage turn-ON temperature.	Simultaneous control of two heating loads. Used where the total load slightly exceeds capacity of a single switch, where two thermostats are impractical. Both switches are calibrated to operate at approx. the same temperature.	Line voltage thermostat with everything; Performance, reliability, durability, and a large knob. Built-in heat anticipation assures close temperature regulation. Large knob for easy rotation.	



Controls Specialty Controls

THERMOSTATS & CONTROLS



	WR80	JC80EP	WT11A	WT12A	LTR SERIES
Action	Snap Action Switch	Snap Action Switch	Positive snap action switch		Electronic Relays
Type	SPST	SPST	SPDT		Microprocessor base design
Watt Rating			Nema 4X rated		These electronic relays have been designed for silent control of high voltage resistive loads from a low voltage control circuit. Inductive motor loads can also be controlled (120V to 240V only). Compatible with 24V thermostats.
120v	25A	25A	25A	n/a	
208v	22A	22A	25A		
240v	22A	22A	25A		
277v	18A	18A	22A		
Pilot Duty	Yes 125VA	Yes 125VA	Yes 125VA		LTR1120: 120V; 22A
Temp. Range (°F)	40°F to 90°F	40°F to 90°F	40°F to 110°F		LTR208240: 208V/240V; 22A
Differential	+/- 3°F	+/- 3°F	+/- 2 ½°F		LTR1277: 277V; 19A
Features	Rugged design for garages, factories, warehouses and similar commercial and industrial installations. The WR80 can control several heaters by using an external contractor.	This explosion proof room thermostat is suitable for Class I, Group D and Class II, Groups E, F, and G locations.	Nema 4X weatherproof enclosure. The control has a SPDT output and can be used for heating or cooling (ventilation) Multi-positional mounting offers flexibility in new or existing installations.		The relays can be used with model LT186F01 electronic room sensor, providing proportional and integral control. Also can be tied to building management systems.



	LTR2240	TC1	M600THW	M600THB
Action	Dual Silent Relay	Enclosure protection for thermostats.	White thermostat cover with built-in thermometer. For M600 Series.	Beige thermostat cover with built-in thermometer. For M600 Series stats.
Type	(2) single pole switches			
Watt Rating	Resistive Inductive	Material: Impact resistant polycarbonate. Clear. Dimensions are: 7" L x 4.28" H x 2.75" D		
120v	N/A			
208v	25A 1HP, 8.8A			
240v	25A 1HP, 8A			
277v	N/A			
Pilot Duty	Yes 125VA	Thermostat enclosure kits are designed to protect the thermostat. Circulating slots allow airflow for proper operation. Guards are lockable and a key is provided to maintain security.		
Temp. Range (°F)	Can be operate in 20 to 140°F			
Differential	Accuracy: Within 1.5°F of setpoint			
Features	This dual level temperature relay may be used to operate two separate heating loads by means of a single low voltage thermostat. Relay is mounted in an enclosure.		Minimum 50pcs. Allow 4 weeks.	



Turn Your Unique Vision Into Reality

MARLEY MADE-TO-ORDER PRODUCTS

Made to Order products offer varying sizes and output levels to give you more control. These products combine depth of configurability with the ease of ordering directly from our catalog.

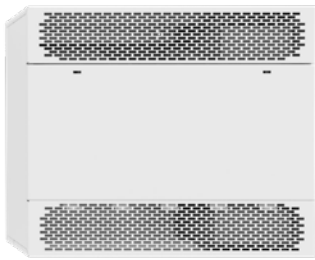

MULTIPLE SIZES & OUTPUTS

Fit your space & heating needs



COMPLETE CONTROL

Thermostats, switches, BMS compatibility



ANY PAINT, ANY PATTERN

Custom finishing & paint matching

Tackle Your Toughest Heating Projects with Marley Engineered Products

Custom Capabilities Team

We integrate custom comfort solutions tailored to your design and performance needs so your team can spend valuable time on other aspects of the project. Whether your space is residential, commercial or industrial, we answer the challenge with unmatched technical expertise and a range of customized product solutions so you can complete the project with zero compromises.

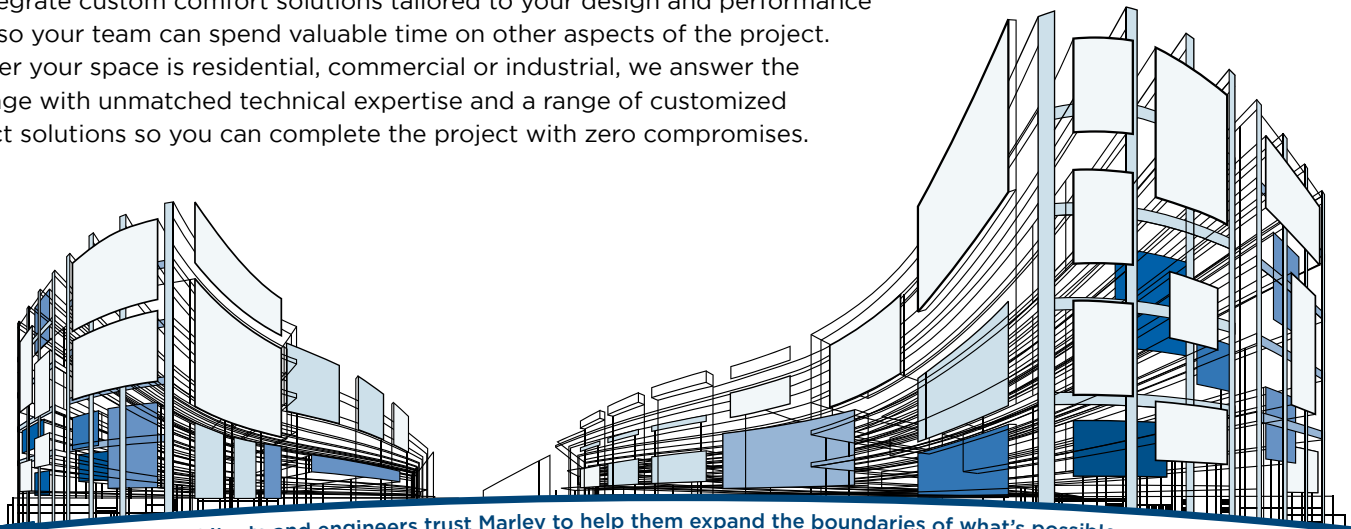

Architects and engineers trust Marley to help them expand the boundaries of what's possible.

TACKLE YOUR TOUGHEST HEATING PROBLEMS

Start your custom project at [CustomHeatSolutions.com](https://www.CustomHeatSolutions.com)

Expand the boundaries of what's possible

with made-to-order products from Marley!

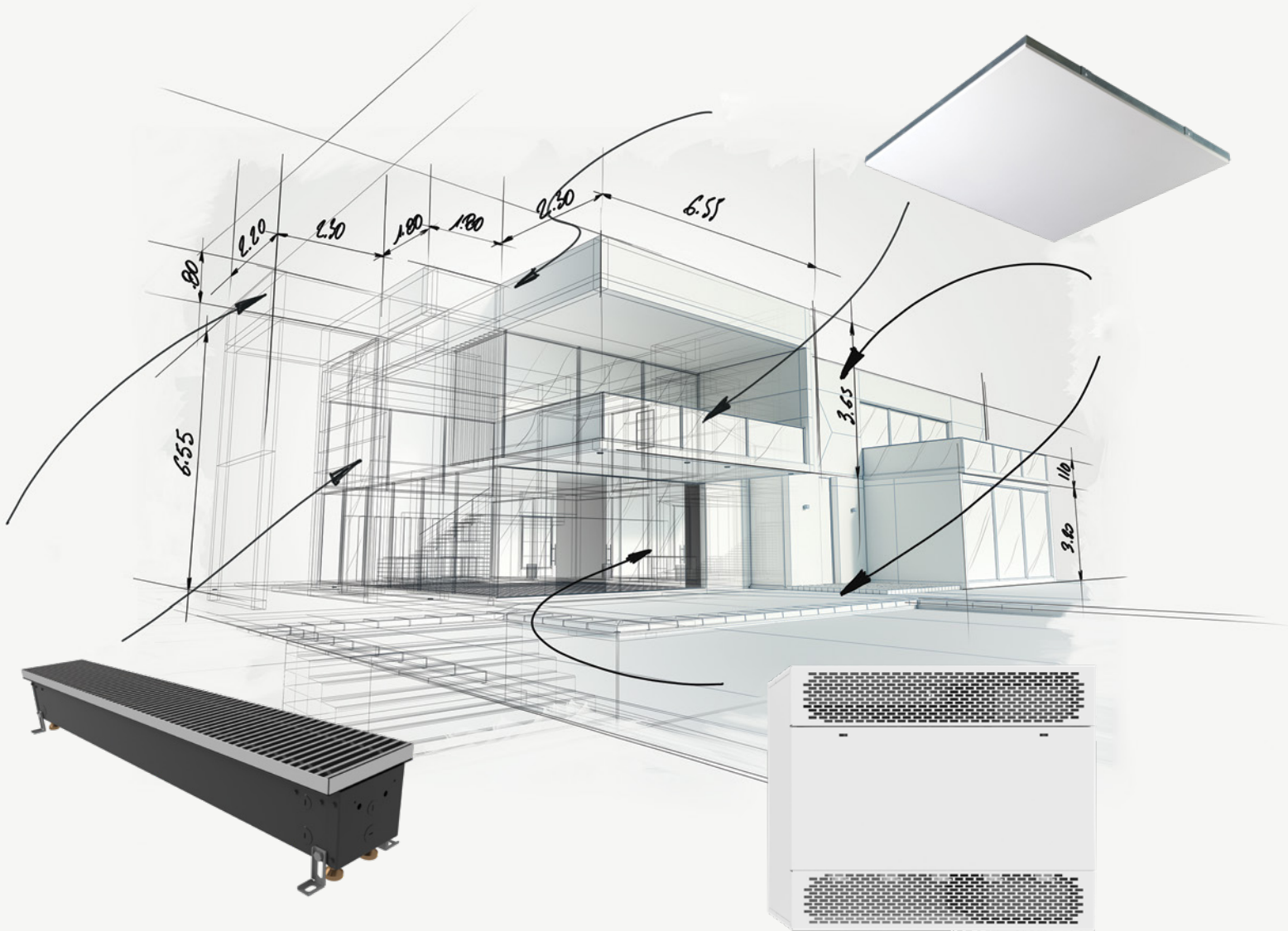

In addition to a full line of stock products, Marley has the custom capabilities to achieve your unique vision.

Backed by decades of
design, engineering and manufacturing experience
let us show you the next generation of electric heat.

FFCH SERIES

Commercial Downflow Ceiling Heater



Technical Specifications:

Temp Range: 45°-90°F | CFM: 300

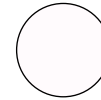

White



Navajo White

kW

2/3/4	2.5/3.8/5
-------	-----------

Voltages

208	240	277
-----	-----	-----

Phase

Single	Three
--------	-------

Optional Accessories:

CATALOG NO.	UPC	DESCRIPTION	SHIP WT.
CDFSE	685360015019	Surface-mounted enclosure (Navajo White) – to be used With above heater section. 20" L x 16-1/2" W x 5-3/4" D	10 lbs
CDFRE	685360014982	Recessed-mounted enclosure (Navajo White) – to be used With above heater section. 23-3/4" L x 23-3/4" W x 7" D	18 lbs
CDFSENW	685360149615	Surface-mounted White – to be used With above heater section. 20" L x 16-1/2" W x 5-3/4" D	10 lbs
CDFRENW	685360149639	Recessed-mounted White – to be used With above heater section. 23-3/4" L x 23-3/4" W x 7" D	18 lbs
CDFT	685360015033	Integral thermostat SPST – Range 45 to 95°F	1 lbs
CDF24R	685360015071	Relay (Time Delay 45-60 sec. to close when energized) requires 24V supply from remote source	1 lbs
CDFR12	685360015002	Relay (Time Delay 45-60 sec. to close when energized) requires 120V supply from remote source	1 lbs
CDFDS_R	685360174952	Recessed Mount Power Disconnect Switch (3-Pole) 30 amps, 600 volts, 3Ø, 60 Hz	1 lbs
CDFDS_S	685360174945	Surface Mount Power Disconnect Switch (3-Pole) 30 amps, 600 volts, 3Ø, 60 Hz	1 lbs
CDFTK	685360015040	Trim Ring for mounting on permanent ceiling (cannot be factory installed)	1 lbs
CDFTR4	685360015057	208/240V Primary Transformer/24V sec. and 24V holding coil control relay	1 lbs
CDFTR7	685360015064	277V Primary Transformer/24V sec. and 24V holding coil control relay	1 lbs
CDFRFK	685360171548	Mounting Bracket Retrofit Kit	2.5 lbs

NOTE: Factory-wired for highest wattage, field-convertible to lower wattages. Factory-wired 1-PH, field convertible to 3-PH dual-phase units, maximum amp draw is listed. Amperage shown is for single phase. For factory installation of above controls, additional charges apply.

Adjustable Airflow Options:

Wide Pattern

(24x8 ft. coverage) In standard ceiling applications (8-10 ft.), heater disperses the air to give a gentle, less pronounced pattern while circulating all the air from floor to ceiling.



Narrow Pattern

(8x8 ft. coverage) For high ceiling applications (11-14 ft.), fan concentrates the heated air to ensure full penetration to the floor level.



Asymmetrical Pattern

(17x10 ft. coverage) Heated air is directed in a specific direction, allowing the heater to be located where space allows, with the heated air delivered to where it is required.



Scan the QR code to access additional specs and features.

SmartSeries® Plus offers the ability to connect to a Building Management System using BACnet MS/TP. This means that once the product is mounted out of reach it can easily be controlled to meet your building needs.



Using a Building Management System allows you to monitor and control those units that are out-of-sight and out-of-mind. This saves time and money with no need to walk to each unit and verify they are running at the correct time.

Want this controller without the added time of configuration?
View the HUHAA-Pro+ and CUHS900-FFWD.

HUHAA-Pro+ Series
page 48

CUHS900-FFWD
page 57

HUHAA SERIES

Unit Heater



This **rugged** unit heater works well in industrial settings. Its **powerful output capacity** even makes it suitable for heating your loading dock or other indoor/outdoor transition spaces.

Dimensions and Clearances:

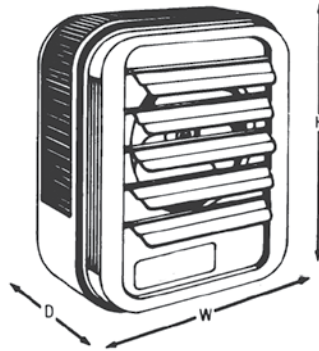

CATALOG NO.	HEIGHT	WIDTH	DEPTH
MUH03 & 05	16"	14"	7 ½"
MUH07 & 10	21 ¾"	19"	7 ½"
MUH15 & 20	21 ¾"	19"	12 ¾"
MUH25 & 30	30"	26 ⅝"	11 ¾"
MUH40 & 50	30"	26 ⅝"	17 ⅝"

Key Features:

Advanced Airflow

This unit heater's pull-through design draws air in across the heating element, so it runs cooler while providing an even blanket of comfort across its output range.

Safe Operation

A linear thermal cutout provides automatic protection the entire length of the heating element. Plus, most models feature a 24V control transformer for safer temperature adjustments.

Precise Positioning

The heater is equipped with individually adjustable louvers that aim your warmth where you need it most. A venturi outlet delivers the additional airflow you need to mount the unit vertically.

Three Times the Metal

The steel sheath heating element is clad in copper and outfitted with aluminum fins. This sophisticated design helps the heater run more safely and cool down faster.

Everything You Need for Installation

This unit heater doesn't require any piping flues, valves or traps. It's self-contained and ready to install wherever you need extra warmth.

Technical Specifications:

Temp Range: 40°-90°F

CFM: 350-3000

Ideal Spaces:

- Factories
- Warehouses
- Garages
- Stairwells
- Shipping Docks
- Power Stations
- Mechanical Rooms

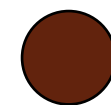

Bronze



Scan the QR code to access additional specs and features.

HUHAA SERIES

Unit Heater

Models & Specifications:

ITEM INFORMATION			ELECTRICAL DATA					AIR DELIVERY DATA FAN MOTOR DATA		SHIP WT:
CATALOG NO.	UPC	VOLTS	PHASE	KW	AMPS	CONTROL VOLT	CFM			
◆	HUHAA320	685360036885	208	1	3	14.5	208	350	27 lbs	
◆	HUHAA520*	685360036977	208	1-3	5	24	208	350	27 lbs	
◆	HUHAA720	685360037011	208	1-3	7.5	36	24	650	38 lbs	
◆	HUHAA1020	685360036731	208	1-3	10	48	24	650	38 lbs	
◆	HUHAA1520	685360036779	208	1-3	15	72	24	910	53 lbs	
◆	HUHAA324	685360036892	208/240	1	2.2/3.0	11.0/12.5	208/240	350	27 lbs	
◆	HUHAA524*	685360036984	208/240	1-3	3.7/5.0	18.0/21.0	208/240	350	27 lbs	
◆	HUHAA724	685360037028	208/240	1-3	5.6/7.5	27.0/31.3	24	650	38 lbs	
◆	HUHAA1024	685360036748	208/240	1-3	7.5/10.0	36.0/42.0	24	650	38 lbs	
◆	HUHAA1524	685360036786	208/240	3	11.2/15.0	31.3/36.1	24	910	53 lbs	
◆	HUHAA327	685360036908	277	1	3	11	277	350	27 lbs	
◆	HUHAA527	685360036991	277	1	5	18	277	350	27 lbs	
◆	HUHAA727	685360037035	277	1	7.5	27	24	650	38 lbs	
◆	HUHAA348	685360036915	480	3	3	3.6	24	350	27 lbs	
◆	HUHAA548	68563047256	480	3	5	6	24	350	27 lbs	
◆	HUHAA748	68563047324	480	3	7.5	9	24	650	38 lbs	
◆	HUHAA1048	68563047386	480	3	10	12	24	650	38 lbs	
◆	HUHAA1548	68563047430	480	3	15	18	24	910	53 lbs	
●	HUHAA2020	685360036809	208	3	20	56	24	1320	60 lbs	
●	HUHAA2024	685360036816	208/240	3	15.0/20.0	41.2/48.0	24	1320	60 lbs	
●	HUHAA2048	685360036823	480	3	20	24	24	1320	60 lbs	
●	HUHAA2548	685360036847	480	3	25	30	24	2100/1800	93 lbs	
●	HUHAA3048	685360036878	480	3	30	36	24	2100/1800	93 lbs	
●	HUHAA4048	685360036939	480	3	40	48	24	3000/2600	114 lbs	
●	HUHAA5048	685360036960	480	3	50	60.2	24	3000/2600	114 lbs	
●	HUHAA3020	685360036854	208	3	30	84	24	2100/1800	93 lbs	
●	HUHAA5020	685360036946	208	3	50	139	24	3000/2600	114 lbs	
●	HUHAA2524	685360036830	208/240	3	18.7/25.0	52.0/60.0	24	2100/1800	93 lbs	
●	HUHAA3024	685360036861	208/240	3	22.5/30.0	63.0/72.3	24	2100/1800	93 lbs	
●	HUHAA4024	685360036922	208/240	3	30.0/40.0	83.4/96.4	24	3000/2600	114 lbs	
●	HUHAA5024	685360036953	208/240	3	37.5/50.0	104.2/120.4	24	3000/2600	114 lbs	
●	HUHAA1027	685360036755	277	1	10	36	24	650	38 lbs	

SKU Legend: ◆ = Popular Products; ● = Extended Offering (Contact your local Marley Sales Representative for typically associated lead times)

*Shipping weight includes mounting bracket

NOTE: All standard units are supplied with a low voltage control transformer and contactor (24V) except HUHAA3 and HUHAA5, 208V, 240V and 277V models. Low voltage control on these units is available on Made to Order (Contact your local Marley Sales Representative for typically associated lead times). All units are also available on special order for 120V control; internal with transformer or external without transformer. On dual-voltage units CFM, FPM, & RPM ratings are listed at higher voltage operation. On dual-phase units maximum amp draw is listed for respective voltage. 25 thru 50 KW models having two-speed motors and dual CFM ratings are listed in Full Line Catalog. 5A. Standard; 5B. *Must use two-stage Thermostat on 3Ø operation.

HUHAA SERIES

Unit Heater

Optional Accessories:

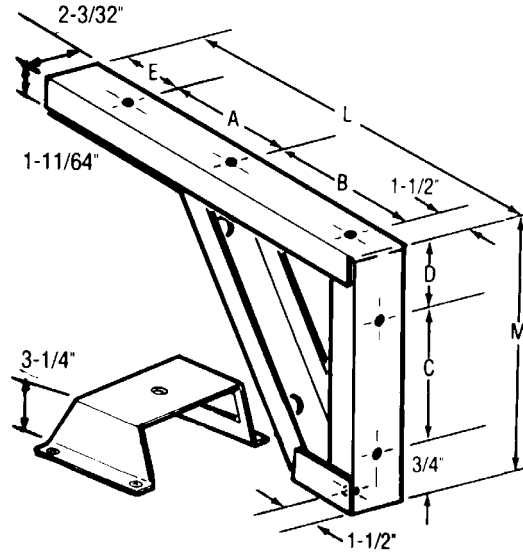
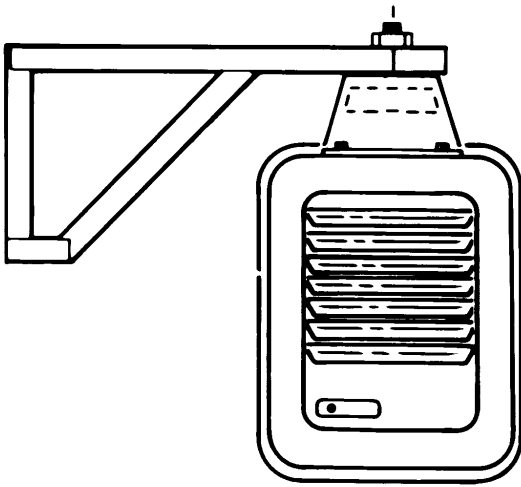

	3-20 kW	25-50 kW
A	7 1/4"	9 7/16"
B	9 1/2"	14 3/8"
C	7 1/4"	12 1/8"
D	11 5/16"	2 1/16"
E	2 1/4"	3"
L	20 1/2"	28 15/16"
M	9 15/16"	14 15/16"
N	3 1/4"	4 1/2"

Optional Mounting Brackets:

	CATALOG NO.	UPC	COMPATIBILITY	SHIP WT.†
Standard	B10	685360152295	MUH03-10	8 lbs
	MCB105PK	685360173627	(Master Pack, Five B10 Brackets)	
	B20	685360152301	MUH15 & 20	10 lbs
	B30	685360152318	MUH25 & 30	13 lbs
	B50	685360152325	MUH40 & 50	15 lbs
Ceiling	CMB10	685360152363	MUH03-10	3 lbs
	CMB20	685360152370	MUH15 & 20	4 lbs
	CMB30	685360152387	MUH25 & 30	5 lbs
	CMB50	685360152394	MUH40 & 50	6 lbs
Vertical Ceiling	VDMB5	685360152455	MUH03-05	5 lbs
	VDMB20	685360152462	MUH07-20	7 lbs
	VDMB50	685360152479	MUH25-50	9 lbs

MOUNTING LIMITATIONS: Unit heaters should not be used in potentially explosive atmospheres. The finish is not intended for direct salt spray exposure in marine applications or the highly corrosive atmospheres of swimming pools, chemical storage bins, etc. Do not install unit heaters above recommended maximum mounting height. Obstructions must not block unit heater air inlet or discharge. Heaters must be mounted at least 7 ft. above the floor to prevent accidental contact with the heating element or fan blade which could cause injury.

Optional Dust Shields:

CATALOG NO.	UPC	COMPATIBILITY	SHIP WT.†
JRDS8	685360150697	3-5 KW units	5 lbs
JRDS14	685360150673	15-20 KW units	6 lbs
JRDS19	685360150680	25-50 KW units	10 lbs

Optional Factory-Installed Controls & Accessories:

DESCRIPTION
MUH03 & 05 (208, 208/240, 277V Supply) 24 or 120V Control Transformer and Power Contactor 24 or 120V H.C. Power Contactor
MUH03 & 05 (480V Supply) & MUH07 through MUH50 Optional 120V Control
2-Stage Control of Elements
Manual Reset
Outlet Mesh (Bird Screen) For all HUHAA Heaters

NOTE: Any factory-installed options require added surcharge. See price book for charges or contact factory.

Optional Field-Installed Electrical Controls:

CATALOG NO.	UPC	DESCRIPTION	ELECTRICAL RATING
UHMT1	685360152417	Single Pole Internal Thermostat-Temp Range: 40°- 85°F	25A @ 120, 240VAC Res. 22A @ 277VAC Res.
UHMT2	685360152424	Two Stage Internal Thermostat-Temp. Range: 40°- 85°F	25A @ 120, 240VAC Res. 22A @ 277VAC Res. 125VA
MCFS	685360046372	Internal Summer Fan Switch 250, 480, 600V.A.C. 1,2 OR 3 PH	Pilot Duty 6A, 600VAC Res. 2 HP
MRFS1	685360047089	Remote Summer Fan Switch (Line Voltage)	2 HP, 250-480VAC
MRFS2	685360047096	Remote Summer Fan Switch with Relay (24V Coil-Single Pole Normally Open)	6 AFL, 35 ALR, 250VAC, 60Hz. 3 AFL, 18 ALR, 480VAC, 60Hz
MHRT	685360046945	Heat Recovery Thermostat with Relay (24V Coil-Single Pole Normally Open) Hi - 120°F, Low - 60°F	6 AFL, 35 ALR, 250VAC, 60Hz 3 AFL, 18 ALR, 480VAC, 60Hz
MPDS25	685360047034	Power Disconnect Switch (3-Pole)	30A @ 600VAC, Res.
MPDS60	685360047041	Power Disconnect Switch (3-Pole)	80A @ 600VAC, Res.

NOTE: Any field installed options assembled in the factory require added surcharge. See price book for charges. MPDS60 disconnect switch is not suitable for field installation on 7.5kw and 10kw unit heaters. Visit website or contact your local representative for compatibility details.

Diffusers for Vertical Mounting:

No Diffuser:

No diffuser needed where a straight downflow air pattern is required. For maximum air throw, remove louvers. Any of three diffusers can be added to basic heater.

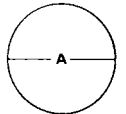
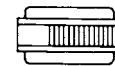

Louver Diffuser:

Permits directional (straight line) air flow as in air curtain application over doorways. Rectangular coverage, Louvers can be turned in either direction.

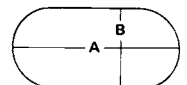
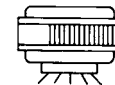

NOTE: Visit website or contact your local representative for additional details

Suggested Controls



Now compatible with SmartSeries Plus when used with 24VAC control transformer!

HUHAA-PRO SERIES

Bundled Unit Heater

Comfort, Convenience, and Connected

The HUHAA-PRO Series Unit Heaters are the same great HUHAA unit heater you rely on every day and now with bundle options to customize your comfort. Bundled options include our most popular safety and control accessories designed to make heating your space effortless and ordering a breeze.

Technical Specifications:

Temp Range: 40°-90°F | CFM: 350-650

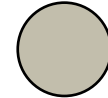

Beige



Bronze



Includes 24VAC Transformer for easy low voltage thermostat connection and future proofing

Includes disconnect switch for safe and easy maintenance or repair

Includes built-in single state thermostat for easy operation right out of the box

HUHAA-Pro+ Series also available!

Includes a SmartSeries® Plus thermostat and a B10 mounting bracket.



Scan the QR code to access additional specs and features.

**NEW
PRODUCT!**

HUHAA SERIES

Unit Heater

Models & Specifications:

ITEM INFORMATION			ELECTRICAL DATA					AIR DELIVERY DATA FAN MOTOR DATA	
CATALOG NO.	UPC	VOLTS	PHASE	KW	AMPS	CONTROL VOLT	CFM	SHIP WT:	
◆ HUHAA320	685360036885	208	1	3	14.5	208	350	27 lbs	
◆ HUHAA520*	685360036977	208	1-3	5	24	208	350	27 lbs	
◆ HUHAA720	685360037011	208	1-3	7.5	36	24	650	38 lbs	
◆ HUHAA1020	685360036731	208	1-3	10	48	24	650	38 lbs	
◆ HUHAA1520	685360036779	208	1-3	15	72	24	910	53 lbs	
◆ HUHAA324	685360036892	208/240	1	2.2/3.0	11.0/12.5	208/240	350	27 lbs	
◆ HUHAA524*	685360036984	208/240	1-3	3.7/5.0	18.0/21.0	208/240	350	27 lbs	
◆ HUHAA724	685360037028	208/240	1-3	5.6/7.5	27.0/31.3	24	650	38 lbs	
◆ HUHAA1024	685360036748	208/240	1-3	7.5/10.0	36.0/42.0	24	650	38 lbs	
◆ HUHAA1524	685360036786	208/240	3	11.2/15.0	31.3/36.1	24	910	53 lbs	
◆ HUHAA327	685360036908	277	1	3	11	277	350	27 lbs	
◆ HUHAA527	685360036991	277	1	5	18	277	350	27 lbs	
◆ HUHAA727	685360037035	277	1	7.5	27	24	650	38 lbs	
◆ HUHAA348	685360036915	480	3	3	3.6	24	350	27 lbs	
◆ HUHAA548	68563047256	480	3	5	6	24	350	27 lbs	
◆ HUHAA748	68563047324	480	3	7.5	9	24	650	38 lbs	
◆ HUHAA1048	68563047386	480	3	10	12	24	650	38 lbs	
◆ HUHAA1548	68563047430	480	3	15	18	24	910	53 lbs	
● HUHAA2020	685360036809	208	3	20	56	24	1320	60 lbs	
● HUHAA2024	685360036816	208/240	3	15.0/20.0	41.2/48.0	24	1320	60 lbs	
● HUHAA2048	685360036823	480	3	20	24	24	1320	60 lbs	
● HUHAA2548	685360036847	480	3	25	30	24	2100/1800	93 lbs	
● HUHAA3048	685360036878	480	3	30	36	24	2100/1800	93 lbs	
● HUHAA4048	685360036939	480	3	40	48	24	3000/2600	114 lbs	
● HUHAA5048	685360036960	480	3	50	60.2	24	3000/2600	114 lbs	
■ HUHAA3020	685360036854	208	3	30	84	24	2100/1800	93 lbs	
■ HUHAA5020	685360036946	208	3	50	139	24	3000/2600	114 lbs	
■ HUHAA2524	685360036830	208/240	3	18.7/25.0	52.0/60.0	24	2100/1800	93 lbs	
■ HUHAA3024	685360036861	208/240	3	22.5/30.0	63.0/72.3	24	2100/1800	93 lbs	
■ HUHAA4024	685360036922	208/240	3	30.0/40.0	83.4/96.4	24	3000/2600	114 lbs	
■ HUHAA5024	685360036953	208/240	3	37.5/50.0	104.2/120.4	24	3000/2600	114 lbs	
■ HUHAA1027	685360036755	277	1	10	36	24	650	38 lbs	

SKU Legend: ◆ = Popular Products; ● = Extended Offering (Contact your local Marley Sales Representative for typically associated lead times)

*Shipping weight includes mounting bracket

NOTE: All standard units are supplied with a low voltage control transformer and contactor (24V) except HUHAA3 and HUHAA5, 208V, 240V and 277V models. Low voltage control on these units is available on Made to Order (Contact your local Marley Sales Representative for typically associated lead times). All units are also available on special order for 120V control; internal with transformer or external without transformer. On dual-voltage units CFM, FPM, & RPM ratings are listed at higher voltage operation. On dual-phase units maximum amp draw is listed for respective voltage. 25 thru 50 KW models having two-speed motors and dual CFM ratings are listed in Full Line Catalog. 5A. Standard; 5B. *Must use two-stage Thermostat on 3Ø operation.

Dimensions and Clearances:

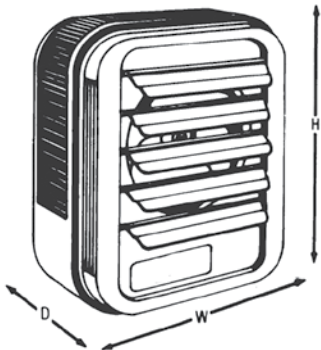

CATALOG NO.	HEIGHT	WIDTH	DEPTH
HUHAA03 & 05	16"	14"	7 1/2"
HUHAA & 10	21 3/4"	19"	7 1/2"
HUHAA & 20	21 3/4"	19"	12 3/4"
HUHAA & 30	30"	26 5/8"	11 3/4"
HUHAA & 50	30"	26 5/8"	17 1/8"

Included with SSP Models



Now compatible with SmartSeries Plus when used with 24VAC control transformer!

HUAA SERIES

Unit Heater

Optional Accessories:

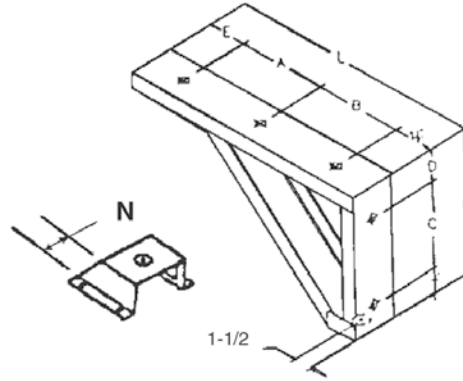
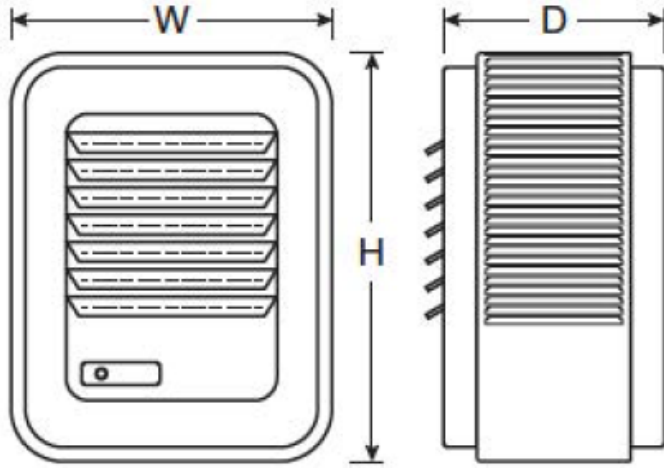

	3-20 kW	25-50 kW
A	7 1/4"	9 7/16"
B	9 1/2"	14 3/8"
C	7 1/4"	12 1/8"
D	11 15/16"	2 1/16"
E	2 1/4"	3"
L	20 1/2"	28 15/16"
M	9 15/16"	14 15/16"
N	3 1/4"	4 1/2"

Optional Mounting Brackets:

	CATALOG NO.	UPC	COMPATIBILITY	SHIP WT.:
Standard	B10	685360152295	HUAA03-10	8 lbs
Ceiling	CMB10	685360152363	HUAA03-10	3 lbs
Vertical Ceiling	VDMB5	685360152455	HUAA03-05	5 lbs

MOUNTING LIMITATIONS: Unit heaters should not be used in potentially explosive atmospheres. The finish is not intended for direct salt spray exposure in marine applications or the highly corrosive atmospheres of swimming pools, chemical storage bins, etc. Do not install unit heaters above recommended maximum mounting height. Obstructions must not block unit heater air inlet or discharge. Heaters must be mounted at least 7 ft. above the floor to prevent accidental contact with the heating element or fan blade which could cause injury.

Optional Dust Shields:

CATALOG NO.	UPC	COMPATIBILITY	SHIP WT.:
JRDS8	685360150697	3-5 KW units	5 lbs
JRDS14	685360150673	15-20 KW units	6 lbs
JRDS19	685360150680	25-50 KW units	10 lbs

Optional Field-Installed Electrical Controls:

CATALOG NO.	UPC	DESCRIPTION	ELECTRICAL RATING
UHMT1	685360152417	Single Pole Internal Thermostat-Temp Range: 40°- 85°F	25A @ 120, 240VAC Res. 22A @ 277VAC Res.
UHMT2	685360152424	Two Stage Internal Thermostat-Temp. Range: 40°- 85°F	25A @ 120, 240VAC Res. 22A @ 277VAC Res. 125VA
HUHAAFS	685360036618	Internal Summer Fan Switch 250, 480, 600V.A.C. 1,2 OR 3 PH	Pilot Duty 6A, 600VAC Res. 2 HP
HUHAARFS1	685360036717	Remote Summer Fan Switch (Line Voltage)	2 HP, 250-480VAC
HUHAARFS2	685360036724	Remote Summer Fan Switch with Relay (24V Coil-Single Pole Normally Open)	6 AFL, 35 ALR, 250VAC, 60Hz. 3 AFL, 18 ALR, 480VAC, 60Hz
HUAAHRT	685360036625	Heat Recovery Thermostat with Relay (24V Coil-Single Pole Normally Open) Hi - 120°F, Low - 60°F	6 AFL, 35 ALR, 250VAC, 60Hz 3 AFL, 18 ALR, 480VAC, 60Hz
HUHAADS25	685360036595	Power Disconnect Switch (3-Pole)	30A @ 600VAC, Res.
HUHAADS60	685360036601	Power Disconnect Switch (3-Pole)	80A @ 600VAC, Res.

NOTE: Any field installed options assembled in the factory require added surcharge. See price book for charges. MPDS60 disconnect switch is not suitable for field installation on 7.5kw and 10kw unit heaters. Visit website or contact your local representative for compatibility details.

Diffusers for Vertical Mounting:

No Diffuser:

No diffuser needed where a straight downflow air pattern is required. For maximum air throw, remove louvers. Any of three diffusers can be added to basic heater.

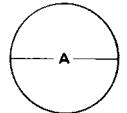
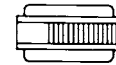

Louver Diffuser:

Permits directional (straight line) air flow as in air curtain application over doorways. Rectangular coverage, Louvers can be turned in either direction.

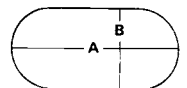
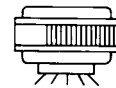

NOTE: Visit website or contact your local representative for additional details

COMFORT WITHOUT COMPROMISE

The contemporary aesthetics of this versatile Cabinet Unit Heater complement modern and future architect specifications. With multiple control options, comfort settings are easily monitored and controlled.



Want the most-common features without the added time of configuration?

View the stock CUHS900-FFWD
on page 57

EASY INSTALL AND MAINTENANCE

- Hinged front panel enables one-person maintenance on ceiling applications
- Front cover interlock de-energizes unit when front cover is removed
- Disposable air filter mounted in inlet air stream

ROBUST DESIGN

- Heavy 16-gauge cold-rolled steel finished with a polyester powder coating provide strength and corrosion resistance
- Motors mounted with automatic thermal overload protection
- Two thermal safety cutouts automatically shut off and protect the heater in the event of overheating

CONTEMPORARY AESTHETICS

- Standard stamped grille with optional ducted grilles

CU900 SERIES

Cabinet Unit Heater

Most versatile heater with multiple sizes, wattages, and airflow options. Multiple control options give you the ability to control your comfort.

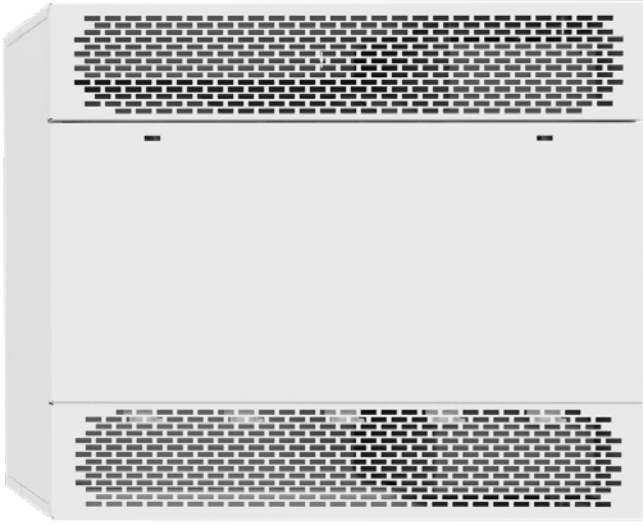

Technical Specifications:

Temp Range: 55°-85°F | CFM: 200-1000 | 60 HZ

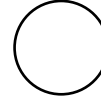

White

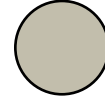

Beige

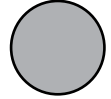

Aluminum

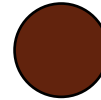

Bronze



Black



Custom Colors

Custom Cabinet Unit Heaters: Models and Specifications

SERIES	KW	BTU/HR	FINAL AIR TEMP	CFM*	208 1Ø	208 3Ø	240 1Ø	240 3Ø	277 1Ø	480 3Ø	SHIP WT.
■ CU935 35 in. (L)	2	6,826	85° F	250	10	6	9	6	8	8	120 lbs
	3	10,239	98° F		15	9	13	8	12	4	
	4	13,652	111° F		20	12	17	10	15	6	
	5	17,065	123° F		25	15	22	13	19	7	
	6	20,478	136° F		30	17	26	15	22	8	
	7	23,891	148° F		34	20	30	18	26	9	
	8	27,304	161° F		39	23	34	20	30	10	
■ CU945 45 in. (L) 160 LBS.	4	13,652	85° F	500	20	12	18	11	16	6	160 lbs
	6	27,478	98° F		30	18	26	16	23	8	
	8	27,304	111° F		40	23	34	20	30	11	
	10	34,130	123° F		48	29	43	25	37	13	
	12	40,956	136° F		59	34	51	30	44	16	
	14	47,782	148° F		68	40	59	35	52	18	
■ CU968 68 in. (L) 260 LBS.	15	51,195	123° F	750	74	44	64	38	56	20	260 lbs
	21	71,673	148° F		-	60	89	52	78	27	
	24	81,912	161° F		-	69	-	60	-	31	
■ CU978 78 in. (L) 300 LBS.	20	68,260	123° F	1,000	-	58	86	50	74	26	300 lbs
	24	81,912	136° F		-	69	-	60	-	31	
	28	95,564	148° F		-	80	-	70	-	36	
	32	109,216	161° F		-	91	-	79	-	41	

SKU Legend: ■ = Made to Order (Contact your local Marley Sales Representative for typically associated lead times)

NOTE: RED numbers represent circuit breakers or fused disconnect required. **380V units will operate with a 16% reduction in heating capacity. +Based on 60°F inlet air temperature. *Values shown is high speed.



Scan the QR code to access additional specs and features.

**NEW
PRODUCT!**

CU900 SERIES

Cabinet Unit Heater

UNIT HEATERS
MARLEY CUSTOM CAPABILITIES

Optional Accessories:

CATALOG NO.	DESCRIPTION	COMPATIBLE WITH	FUNCTION	SHIP WT.
CU935RTK	Ceiling or Wall Recess Trim Kit	CU935	Provides a neat finish to semi-recessed or full recessed application.	3 lbs
CU945RTK		CU945		4 lbs
CU968RTK		CU968		6 lbs
CU978RTK		CU978		7 lbs
CU935BK	Floor/Toe-Space Base Kit	CU935	16 gauge, muted black base is recessed from the heater front and sides to provide an attractive and practical floor mounting application.	9 lbs
CU945BK		CU945		10 lbs
CU968BK		CU968		13 lbs
CU978BK		CU978		15 lbs
CU935WF	Permanent, Reusable Washable Filter	CU935	Replaces standard filter Washable filter can be cleaned and replaced.	4 lbs
CU945WF		CU945		6 lbs
CU968WF		CU968		10 lbs
CU978WF		CU978		12 lbs

Suggested Controls



Now compatible with SmartSeries Plus when used with 24VAC control transformer!

Optional Factory-Installed Accessories:

ACCESSORY	DESCRIPTION	
	STANDARD	OPTIONAL
2-Stage Thermostat Built-or Remote	Built-in (or remote-mounted) single-pole, single-stage thermostat that cycles the element(s) and fan. Fan speed and element wattage selected by the built-in HIGH or LOW selector switch.	Built-in (or remote-mounted) two-stage thermostat that cycles 2/3 of the element for during first stage and full heat during second stage. Fan cycles on high speed only.
Smartseries® Plus (Built-In -r Remote)	Built-in (or remote mounted) two stage thermostat runs 2/3 elements on stage 1 and full heat for stage 2. Fan cycles on high speed only. Comes with BACnet BMS compatibility, scheduling, cooling mode(Fan-Only), and keypad lock.	Supply terminal block in the control compartment.
Dead Front Disconnect Switch	A three pole non-fused disconnect switch disconnects power to the heater. Design prevents entry into the control compartment until disconnect switch is turned to the OFF position.	Supply terminal block in the control compartment.
Dead Front Fused Disconnect Switch†	A three pole non-fused disconnect switch and circuit breaker(s) sized to the heater load protects heater and disconnects power to the heater.	Design prevents entry into the control compartment until disconnect switch is turned to the OFF position.
On/Off Switch	No switch supplied.	Built-in switch provides continuous fan operation with or without heat, or automatic fan cycling as the heat cycles on and off.
Key Lock For Front Cover	Two (2) slotted head spring latches.	Two (2) toolhead key lock style spring latches prevent unauthorized adjustment of controls and provides additional safety from injury due to contact with internal components.
Inlet or Discharge Duct Collar(S)	Standard Architectural Grilles	Collars provide easy connection of field supplied duct work. We do not recommend exceeding 0.2 in. wg external static pressure. Heater with duct collars are supplied with a single speed high static motor.
Louver Grilles	Standard Architectural Grille.	Retrofit option to match the old louver design of the cabinet unit heater. This option is only available for both inlet and discharge openings ordered at the same time. Can not be ordered separately.

† Plus price of circuit breaker.

Multiple Air Flow Combinations:

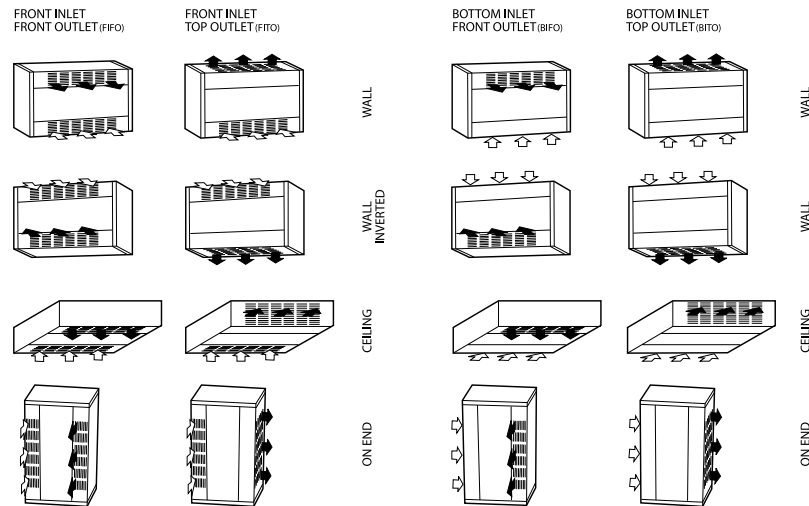

Dimensions and Clearances:

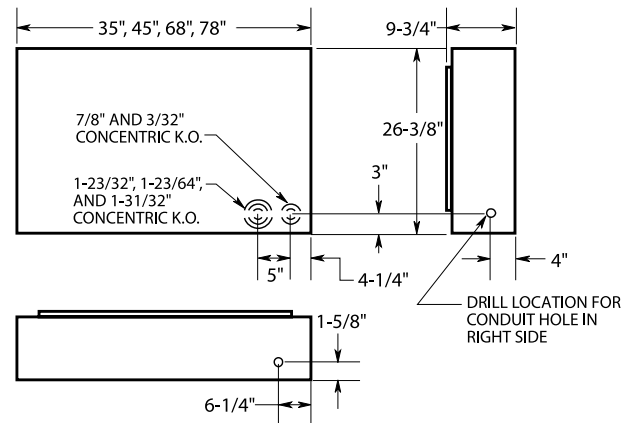

OPEN COIL ELECTRIC

Duct Heater

UNIT HEATERS
MARLEY CUSTOM CAPABILITIES



This heater is the epitome of out-of-sight out-of-mind comfort giving you a **boost of heat for any duct system**. The two models give you the flexibility to install in both **rectangular or round ducts** and the flip-able design allows it to be installed anywhere.

Key Features:

Flexible Design

Flip-Able design and wide range of available sizes and voltages offers complete flexibility when specifying a job.

Longer Lifetime and Less Nuisance Tripping

Elements come standard with a watt density of 30 kW/sqft and offered Derated Heating Coils improve heater element life and nuisance tripping.

Convenient Quoting

New easy to use online configurator saves time and money while getting you the exact product you need for your application.

Hidden Heat

UL and ETL approved for incorporation into the duct work so no new holes in the wall or ceiling and no bulky product visible in room.

Ideal Spaces:

Office Buildings
Retail Stores
Warehouses
Schools
Hotels
Hospitals

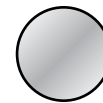

Stainless Steel



Scan the QR code to access additional specs and features.

**NEW
PRODUCT!**

How to Order an Open Coil Electric Duct Heater

In almost every application, a duct heater needs to be highly configured and specialized to meet the demand of the space it is going in. To do this efficiently, we have created a new configuration process making it fast and easy to get the product you need. This page is designed to show you all the standard options available and how to decipher the part number to configure the specific heater you are ordering. (If there is a size larger or additional options needed, you will have to go through the Non-Standard Process for a quote.)

Open Coil Duct Heater Smart Part Number

Brand (1 plc)	Mounting (1 plc)	Element Style (1 plc)	Revision (1 plc)	kW (3 plc)	Supply Voltage/Phase (1 plc)	Insulation Thickness (in.) (2 plc)	Stages (2 plc)	Control Voltage (1 plc)	Width* (3 digits)	Height* (3 digits)
B (Berko)	S (Slip-In)	C (Open Coil)	A	### (001-100)	1 = 120V 1 Ph	00 = 0.0"	01 = 1 Stage	1 = 24V	### (006-120)	### (006-144)
					2 = 208V 1 Ph	05 = 0.5"		2 = 120		
3 = 208V 3 PH	10 = 1"				02 = 2 Stage	3 = 208				
4 = 240V 1 PH	15 = 1.5"					4 = 240				
Q (QMark)	R (Round Collar)				5 = 240V 3 PH	20 = 2"	03 = 3 Stage	5 = 277		
					6 = 277V 1 PH	25 = 2.5"		6 = 480		
					7 = 480V 1 PH	30 = 3"				
					8 = 480V 3 PH					

*For round Duct Heaters diameters are 06 = 6 inch, 08 = 8 inch, and 010 = 10 inch

Control Options (11 plcs)

Heater Controls (1 plc)	Time Delay (1 plc)	Airflow Switch (1 plc)	Power Fusing (1 plc)	Disconnect Switch (1 plc)
0 = None	0 = None	0 = None	0 = None	0 = None
A (SCR)	A (Time Delay Relay, Heater On)	A (Airflow Switch, non-adjustable)	A (Power Fusing)	A (Disconnect Switch)
B (Step Controller, Analog Signal Required)				
C (Fan Interlock)	B (Time Delay Relay, Delay Between Stages)	B (Airflow Switch, adjustable)		
D (Heater Interlock, Disable/Enable Heater)	C (Time Delay Relay, Heater On & Delay Between Stages)			
E = SCR and Heater interlock				

Control Options (11 plcs) cont.

Control Transformer (1 plc)	Thermostat (1 plc)	Coil (1 plc)	Derated (1 plc)	Pilot Light (1 plc)	Control Box (1 plc)
0 = None	0 = None	0 = None	0 = None	0 = None	0 = None
A (Control Transformer)	A (Thermostat, Wall Mount)	A (Stainless Steel Coil Terminals for Corrosion Resistance)	A (Derate to 35 Watts)	A (Pilot Light, Heater Power On)	A (Vapor Barrier)
B (Control Transformer & Primary Fusing)				B (Pilot Light, Heater Energized)	B (Dust Tight Box)
C (Control Transformer & Secondary Fusing)	B (Thermostat, with Remote Sensor)	B (80/20 Corrosion Resistant Wire)	B (Derate to 25 Watts)	C (Pilot Light, Stage On, 1 per stage)	C (Outdoor Rated)
D (Control Transformer & Secondary & Primary Fusing)	C (Thermostat, with Duct Sensor)	C (Stainless Steel Element Rack)		D (Pilot Light, Airflow Switch Open)	D (Dust Tight Box & Vapor Barrier)

Sample

Customer Order: Berko, Flanged, Open Coil, First Revision, 24 kW, 208V 3 PH, 1", 1 Stage, 24V, 20" Width, 14" Height, SCR Heater Controls, No Time Delay, Non-Adjustable Airflow Switch, No Power Fusing, Disconnect Switch, Control Transformer & Primary Fusing, Thermostat, Wall Mount, No Coil, Pilot Light, Derate to 35 Watts, Heater Power On, No Control Box.

B	F	C	A	024	3	10	01	1	020	014	A	0	A	0	A	B	A	0	A	A	0
---	---	---	---	-----	---	----	----	---	-----	-----	---	---	---	---	---	---	---	---	---	---	---

Notes: 1. Please see the installation instructions for installation details and restrictions. 2. For slip in heaters being installed into an internally insulated duct, decrease the height by 2 times the insulation thickness, decrease the width by the insulation thickness, and add a recess equal to the insulation thickness. 3. All heaters will require either a fan relay or an airflow switch per UL requirements. If neither is chosen, a fan relay will be specified. If both a fan relay and airflow switch are required, both must be specified as options/accessories. 4. Power fusing is standard on all heaters above 48.0 amps. Power fusing must be specified as an option/accessory if required for heaters rated 48 amps or less.

Perimeter heat that promotes your vision

CONVECTORS
MARLEY CUSTOM CAPABILITIES

Convection heaters warm air at the base of exterior windows, creating a natural updraft that protects your building's heat envelope and curtain walls. Windows stay free of fog and condensation and warm air circulates throughout the space with no need for a fan or blower.

INCREASED OUTPUT, CONTROL OPTIONS, AND CUSTOM CAPABILITIES



BDBSL



ASLC



ASL3

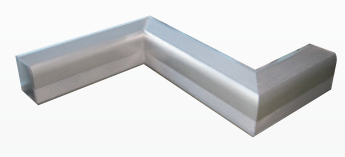

ASL5



Did You Know?

We have a full complimenting line of steel convectors available for applications that require a different construction, aesthetic, or layout.



Convectors create an **effective draft barrier** to minimize perimeter heat loss and prevent condensation against glazing, as well as add heat to offices, schools, lobbies or any space with large window spans or cold spots.



Quiet, Natural Airflow. Convectors do not require a fan or ducting, so they don't circulate dust and other allergens. They provide safe, easy-to-maintain source of heat with no moving parts.



Custom convectors are premium supplemental heat solutions that **won't compromise your buildings aesthetics.** These units can be ordered with any length, corner or trim option you need and are designed to your exact specifications for a fully integrated comfort solution.



Control Options. Add anything from a single-unit, built-in thermostat to a fully BMS-compatible silicon controlled rectifier to best command your building's heating system.

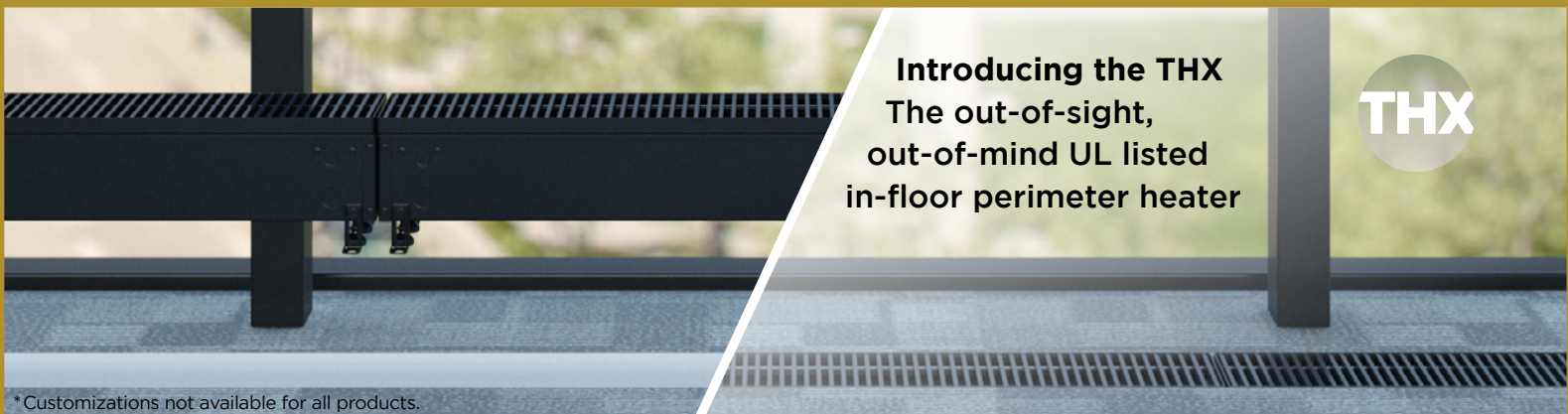

Introducing the THX
The out-of-sight,
out-of-mind UL listed
in-floor perimeter heater

THX

*Customizations not available for all products.

WHERE DESIGN AND COMFORT MEET

THX zero vertical profile eliminates visual disruptions while preserving the building's heat envelope and amplifying building aesthetics. Maximize building comfort and reclaim floor space with the most compact, in-floor convector on the market today.

Brought to you by Marley Engineered Products—a trusted leader in comfort solutions—THX is designed with durability in mind to withstand daily cleaning, water and debris.



THE OUT-OF-SIGHT,
OUT-OF-MIND
UL LISTED **IN-FLOOR**
PERIMETER HEATER

THX™ SERIES

UL Listed In-Floor Perimeter Convection Heater

CONVECTORS
MARLEY CUSTOM CAPABILITIES

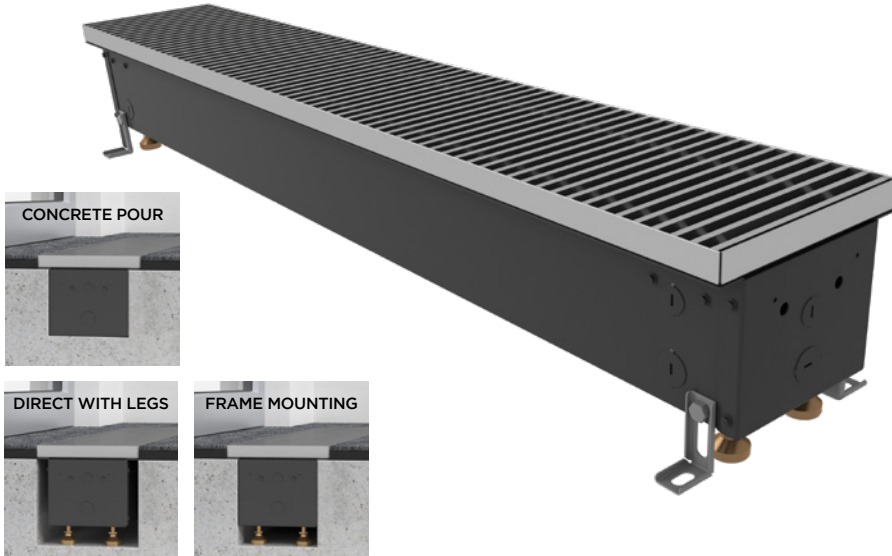

Where design and comfort meet. Maximize building comfort and reclaim floor space with THX. Its zero vertical profile **eliminates visual disruptions** while preserving the building's heat envelope and amplifying building aesthetics. From design to installation and servicing, the THX is built to be quickly and **easily installed and maintained** in order to provide the superior comfort solutions your client demands.

Key Features:

Easy extensibility

THX units come in 2- to 5-foot modular lengths for easy one-person handling and wiring when adding multiple units.

Easy Mounting

Listed for concrete pour, mounting with legs or using a frame. Included leveling legs raise the unit to the appropriate height for flush installations and optional mounting legs provide an additional securing point.

Rated for High Traffic Areas

THX units can support double the UL weight test rating — durable enough to stand up to foot traffic in busy spaces. These units are placed in the floor where they won't show dents and scratches as easily as other heaters

Easy Installation and Maintenance

All units are factory wired and preassembled for out-of-the-box readiness. drop-in installation, and easy access for cleaning and maintenance, with one service professional.

UL Listed Out-of-the-Box with Sealed J-Boxes

Avoid the time and expense of certifying on site. THX is designed with water and debris management in mind. It features a sealed junction box and raised connection points, plus a wire screen beneath the grille catches debris to prevent it from entering the unit.



Scan the QR code to access additional specs and features.

Ideal Spaces:

- Conference Rooms
- Hallways
- Lobbies
- Offices
- Retail Spaces
- Floor-to-Ceiling Curtain Walls



Conforms to
ANSI/UL2021 and
CSA C22.2, NO. 46

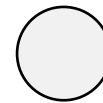

White



Black

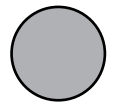

Aluminum

**NEW
PRODUCT!**

THX™ SERIES

UL Listed In-Floor Perimeter Convection Heater

CONVECTORS
MARLEY CUSTOM CAPABILITIES

Models & Specifications:

MODEL	LENGTH	WATTS PER FT*	TOTAL WATTS	AMPERAGE			# OF ELEMENTS	SHIP WEIGHT LBS.
				208 VAC	240 VAC	277 VAC		
THXB 02188	2'	188	376 (1282)	1.8	1.6	1.4	1	30
THXB 02250		250	500 (1705)	2.4	2.1	1.8		
THXB 03188	3'	188	564 (1923)	2.7	2.4	2.0		40
THXB 03250		250	750 (2558)	3.6	3.1	2.7		
THXB 04188	4'	188	752 (2564)	3.6	3.1	2.7		52
THXB 04250		250	1000 (3410)	4.8	4.2	3.6		
THXB 05188	5'	188	940 (3205)	4.5	3.9	3.4	60	
THXB 05250		250	1250 (4263)	6.0	5.2	4.5		

SKU Legend: ■ = Made to Order (Contact your local Marley Sales Representative for typically associated lead times)
For all sizes above 5', the units can be modularized together. Reference instruction manual for additional detail. For additional output contact Marley's Technical Services.



THX warms air at the base of exterior windows, creating a natural updraft that protects your building's heat envelope and curtain walls.

Optional Built-In Controls:

SUFFIX*	OPTIONAL BUILT-IN CONTROL	USE CASE(S)	RATINGS & DESCRIPTION
DS	Power On/Off Switch	Ideal for servicing	Double-pole, rated 20 amp @ 120-277 VAC. (See Note A) For three-phase heaters and single-phase heaters over 20 amps specify two.
TR	Transformer "Relay"	Ideal for remote, low voltage thermostats	Single-pole, low voltage relay with built-in transformer (24 VAC control), rated 22 amps @ 120-240 VAC and 22 amps @ 277 VAC. (See note E) 17 amps @ 347V. Not available on three-phase heaters.
PR	Power Relay	Ideal for multiple heater connections or BMS / EMS connections	Single-pole thermal time delay relay, rated 25 amps @ 120-600 VAC. (See Notes E & F). Specify control voltage.

*Addition To Basic Catalog No. (See Note D) NOTE: Reference the submittal sheet or additional detail

Optional Accessories:

ACCESSORY	DESCRIPTION
Blank Sections	12", 18", 2', 3', 4', 5'
Corner Sections	90° (without grille)

FLUSH GRILLE DIMENSIONS				
Size	2 ft.	3 ft.	4 ft.	5 ft.
Length	24 1/8" (613mm)	36 1/8" (918mm)	48 1/8" (1,223mm)	60 1/8" (1,528mm)
Grille Width	7 7/8" (200mm)			
Cabinet Width	6 1/8" (156mm)			
Depth	6 1/8" (156mm)			
A - Diameter (Nested)	1/2" (3/4")			
B - Diameter	1/2"			
Leveling Leg Adjustment	1-2" (26-52mm)			

SURFACE GRILLE DIMENSIONS				
Size	2 ft.	3 ft.	4 ft.	5 ft.
Length	26 1/8" (664mm)	38 1/8" (969mm)	50 1/8" (1,273mm)	62 1/8" (1,578mm)
Grille Width	9 7/8" (251mm)			
Cabinet Width	6 1/8" (156mm)			
Depth	6 1/8" (156mm)			
A - Diameter (Nested)	1/2" (3/4")			
B - Diameter	1/2"			
Leveling Leg Adjustment	1-2" (26-52mm)			

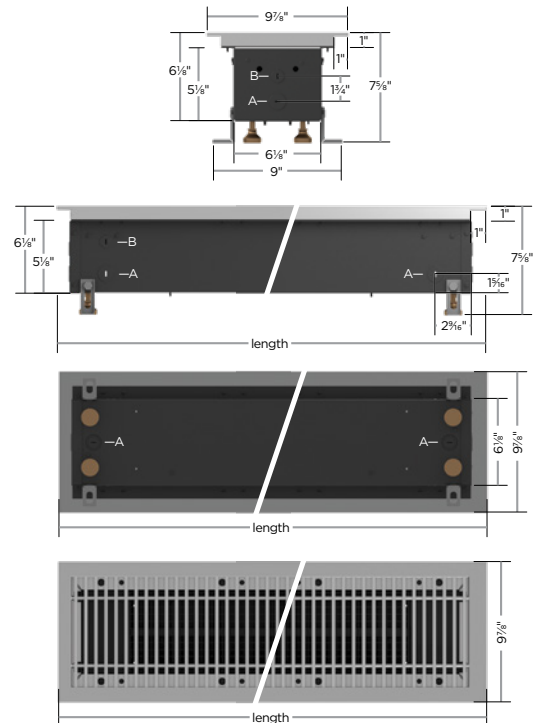
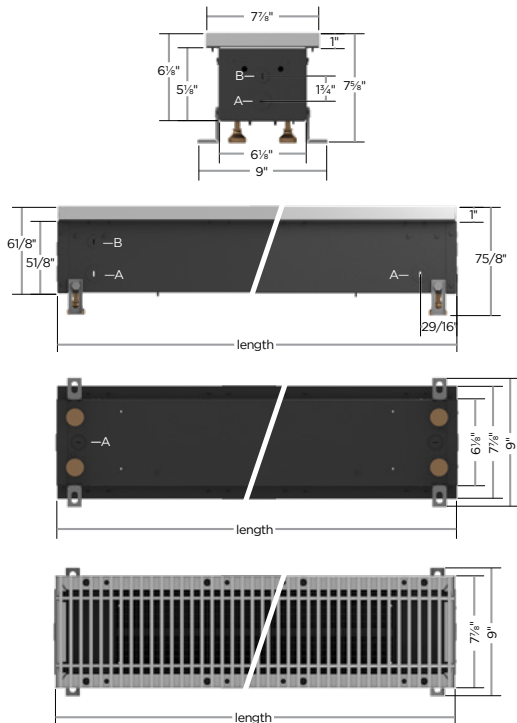

ASL3 & ASL5 SERIES

Architectural Sill-Height Convectors



Complement your architectural vision with these sill-height, extruded aluminum convectors. **Designed for simple installation, flexible output and control options, and easy customization**, these architectural convectors are the perfect choice to add heat and draft barrier protection to atriums, lobbies and other areas with floor-to-ceiling glass.

Key Features:

Ultimate Design Flexibility

The two available sizes provide ultimate flexibility and configurations to meet any requirements a space could need: from output, controllability, and aesthetics.

2-Piece Extruded Aluminum Construction

For rapid installation and easy maintenance, these extruded aluminum convectors feature a simple, two-piece design. The “Snap-Lock” closure allows you to easily secure the two pieces with no need for other fasteners.

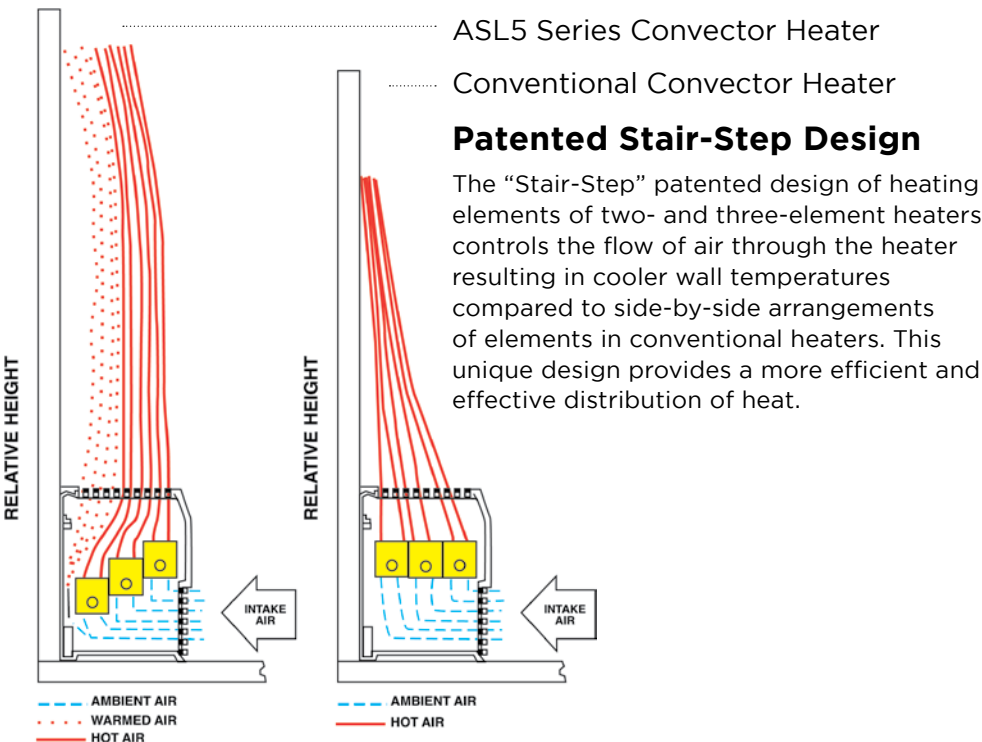

Ideal Spaces:

- Living Rooms
- Bedrooms
- Offices
- Hallways & Lobbies
- Condos
- Conference Rooms;
- Retail Spaces
- Floor-to-Ceiling Curtain Walls

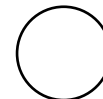

White

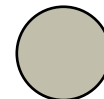

Beige



Charcoal Grey

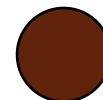

Bronze



Black

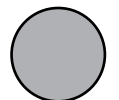

Aluminum



Custom and/or Anodized Colors also Available



Scan the QR code to access additional specs and features.

ASL3 & ASL5 SERIES

Architectural Sill-Height Convectors

ASL3 & ASL5 (1 Element) Lengths

Length	28"	3'	4'	5'	6'	7'	8'	9'	10'
Shipping Weight	8 lbs	10 lbs	13 lbs	17 lbs	20 lbs	24 lbs	27 lbs	30 lbs	33 lbs

NOTE: Cabinet available up to 15 ft. length. Custom length cabinets are priced with heater and blank to the next larger size. Backs are provided standard with no finish. For finished backs, add 10% to list price. Knockouts on back omitted by request only. All models are NON-STOCK made-to-order. When ordering, specify quantity, catalog number, voltage, wattage, optional controls, and color. Consult sales representative for lead times.

Watts per Ft.*

100	125	150
188	250	

Voltages*

120	208	240	277
480	347	600	

ASL5 (Multiple Elements) Lengths

Length	28"	3'	4'	5'	6'	7'	8'	9'	10'
Shipping Weight	12 lbs	15.5 lbs	20 lbs	25.5 lbs	30 lbs	35 lbs	40 lbs	45 lbs	50 lbs

NOTE: Cabinet available up to 15 ft. length. Custom length cabinets are priced with heater and blank to the next larger size. Backs are provided standard with no finish. For finished backs, add 10% to list price. Knockouts on back omitted by request only. All models are NON-STOCK made-to-order. When ordering, specify quantity, catalog number, voltage, wattage, optional controls, and color. Consult sales representative for lead times.

Watts per Ft. — 2 Elements*

375	500
-----	-----

Voltages — Single Phase*

208	240	277	347	600
-----	-----	-----	-----	-----

Watts per Ft. — 3 Elements*

600	750
-----	-----

Voltages — Three Phase*

208	240	600
-----	-----	-----

*Specs vary by length. Reference the submittal sheet or additional detail

Optional Built-In Controls:

SUFFIX*	OPTIONAL BUILT-IN CONTROL	RATINGS & DESCRIPTION
T	Single-Pole Thermostat	Rated 25 amps @ 120-240 VAC and 22 amps @ 277 VAC. Pilot duty rating of 125 VA (all voltages). 60-120°F temperature range; adjustable through outlet grille-tamper-resistant. (See Note B) Not available on three-phase heaters.
2T	Double-Pole Thermostat	Rated 25 amps @ 120-240 VAC and 22 amps @ 277 VAC. Pilot duty rating of 125 VA (all voltages). 60-120°F temperature range; adjustable through outlet grille-tamper-resistant. (See Note B for amperage restrictions.)
DS	Power On/Off Switch	Double-pole, rated 20 amp @ 120-277 VAC. (See Note A) For three-phase heaters and single-phase heaters over 20 amps specify two.
TR	Transformer Relay	Single-pole, low voltage relay with built-in transformer (24 VAC control), rated 22 amps @ 120-240 VAC and 22 amps @ 277 VAC. (See note E) 17 amps @ 347V. Not available on three-phase heaters.
PR	Power Relay	Single-pole thermal time delay relay, rated 25 amps @ 120-600 VAC. (See Notes E & F). Specify control voltage.
2ST	2-Stage Thermostat	Rated 24 amps @ 120-240 VAC and 22 amps @ 277 VAC. Pilot duty rating of 125 VA (all voltages). 60-120°F temperature range, adjustable through outlet grille-tamper-resistant. Available on 2- or 3-element, single-phase heaters only.
PDT	Single-Pole Thermostat	Same as -T except Pilot Duty. (See Note C)
2TPD	Double-Pole Thermostat	Same as -2T except Pilot Duty. (See Note C & D)
M	Outlet Mesh	Price per foot

NOTE: *Addition To Basic Catalog No. (See Note D)

A. For single-phase loads over 20A and all three-phase loads, specify (2) power on/off switches. **B.** This control option is not available on single-phase heaters over 25 amps (22 amps on 277 VAC). In combination with the power on/off switch option use the 2ST thermostat option on heaters over 20 amps. **C.** A second transformer relay can be sequenced off the first transformer relay in the same heater. Up to 30 power relays in different heaters can be controlled by (1) single-stage pilot duty thermostat. **D.** Up to 30 power relays in different heater can be controlled by each stage of a two-stage pilot duty thermostat. **E.** Two relays are required on single-phase heaters over 20 amps with a power on/off switch, over 25 amps without a power on/off and on all three-phase heaters. Two relays are available for two-stage on two- or three-element heaters only. **F.** Three power relays are available for three-stage on three-element heaters only. **G.** Fits in ASL5 unit only. For ASL3, PE will be installed in 4 1/2 in. section.

Dimensions and Clearances:

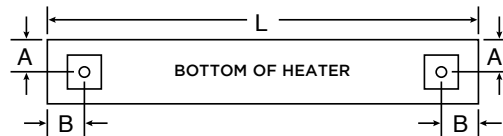
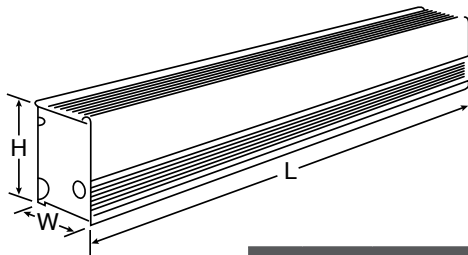

Cat. No.	Dimensions		
	H	W	L
DBA	6"	3 5/8"	28"-15'
SHA	7"	5 5/8"	28"-12'

Cat. No.	Standard Pedestal Placement	
	A	B
DBA	2"	2 1/4"
SHA	2 13/16"	2 1/4"

ASL3 & ASL5 SERIES

Architectural Sill-Height Convectors

Blank Sections & Accessories — ASL3 Series:

CATALOG NO.	DIMENSIONS (W x H x L)	INLET	SHIP WT.
ASL3BS1F	3 3/8" x 6" x 1'	Front	4 lbs
ASL3BS1B		Bottom	
ASL3BS2F	3 3/8" x 6" x 28"	Front	7 lbs
ASL3BS2B		Bottom	
ASL3BS3F	3 3/8" x 6" x 3'	Front	9 lbs
ASL3BS3B		Bottom	
ASL3BS4F	3 3/8" x 6" x 4'	Front	12 lbs
ASL3BS4B		Bottom	
ASL3BS5F	3 3/8" x 6" x 5'	Front	16 lbs
ASL3BS5B		Bottom	
ASL3BS6F	3 3/8" x 6" x 6'	Front	19 lbs
ASL3BS6B		Bottom	
ASL3BS7F	3 3/8" x 6" x 7'	Front	22 lbs
ASL3BS7B		Bottom	
ASL3BS8F	3 3/8" x 6" x 8'	Front	24 lbs
ASL3BS8B		Bottom	
ASL3BS9F	3 3/8" x 6" x 9'	Front	27 lbs
ASL3BS9B		Bottom	
ASL3BS10F	3 3/8" x 6" x 10'	Front	30 lbs
ASL3BS10B		Bottom	

NOTE: Blank section grilles are not punched unless requested.

CATALOG NO.	DESCRIPTION	ADDITIONAL SPACE REQUIRED	SHIP WT.
ASL3ECLS	End Cap w/Screws - Left		
ASL3ECRS	End Cap w/Screws - Right		
ASL3ICF	Inside Corner-Front In	8 1/2"	5 lbs
ASL3ICB	Inside Corner-Bottom In	8 1/2"	5 lbs
ASL3OCF	Outside Corner-Front In	5"	4 lbs
ASL3OCB	Outside Corner-Bottom In	5"	4 lbs
ASL3135ICF	135° Inside Corner-Front In	8 1/2"	5 lbs
ASL3135ICB	135° Inside Corner-Bottom In	8 1/2"	5 lbs
ASL3135OCF	135° Outside Corner-Front In	5"	4 lbs
ASL3135OCB	135° Outside Corner-Bottom In	5"	4 lbs
ASL3DESB	Dec. End Section-Bottom In, Left	9 3/4"	5 lbs
ASL3DESB	Dec. End Section-Bottom In, Right		5 lbs
ASL3DESFL	Dec. End Section-Front In, Left		4 lbs
ASL3DESFR	Dec. End Section-Front In, Right		4 lbs
ASL3SP	Splice Plate	0-1/4"	1 lbs
ASL3FL3	Filler Section 3 in.	0-3"	1 lbs
ASL3FL6	Filler Section 6 in.	3-6"	1 lbs
ASL3FL9	Filler Section 9 in.	6-9"	1 lbs
ASL3FL12	Filler Section 12 in.	9-12"	1 lbs
ASL3-FL18	Filler Section 18 in.	15-18"	1.5 lbs
ASL3DRF	Receptacle Section-Front In	4 1/2"	1.5 lbs
ASL3DRB	Receptacle Section-Bottom In		
ASL3PEF	Pneu/Ele Sw-Fnt. In	4 1/2"	2 lbs
ASL3PEB	Pneu/Ele Sw-Bot. In		
PK3S*	Standard Pedestal 2 3/8 in. (H)	-	2 lbs
PK3A*	Architectural Pedestal 2 3/8 in. (H)	-	2 lbs
SO1A	Stand-Off Bracket	-	1 lbs

*One pedestal. Two required on units up to 10 ft., three required on units over 10ft.

**Add suffix -P for painted, -C for clear anodized, -B for bronze anodized (excludes PK3S - Black only).

***All Stand-off Brackets come standard as Beige.

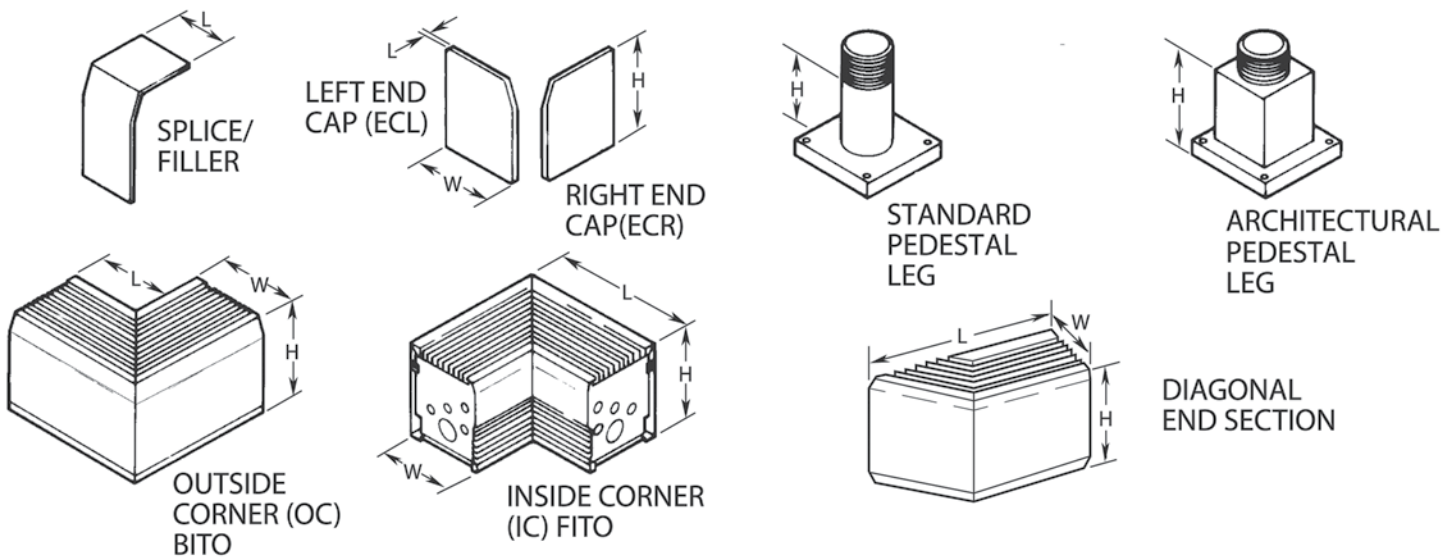

ASL3 & ASL5 SERIES

Architectural Sill-Height Convectors

Blank Sections & Accessories — ASL5 Series:

CATALOG NO.	DIMENSIONS (W x H x L)	INLET	SHIP WT.
ASL5BS1F	5 3/8" x 7" x 1'	Front	7 lbs
ASL5BS1B		Bottom	
ASL5BS2F	5 3/8" x 7" x 28"	Front	11 lbs
ASL5BS2B		Bottom	
ASL5BS3F	5 3/8" x 7" x 3'	Front	14 lbs
ASL5BS3B		Bottom	
ASL5BS4F	5 3/8" x 7" x 4'	Front	18 lbs
ASL5BS4B		Bottom	
ASL5BS5F	5 3/8" x 7" x 5'	Front	22 lbs
ASL5BS5B		Bottom	
ASL5BS6F	5 3/8" x 7" x 6'	Front	27 lbs
ASL5BS6B		Bottom	
ASL5BS7F	5 3/8" x 7" x 7'	Front	32 lbs
ASL5BS7B		Bottom	
ASL5BS8F	5 3/8" x 7" x 8'	Front	37 lbs
ASL5BS8B		Bottom	
ASL5BS9F	5 3/8" x 7" x 9'	Front	40 lbs
ASL5BS9B		Bottom	
ASL5BS10F	5 3/8" x 7" x 10'	Front	44 lbs
ASL5BS10B		Bottom	

NOTE: Blank section grilles are not punched unless requested.

CATALOG NO.	DESCRIPTION	ADDITIONAL SPACE REQUIRED	SHIP WT.
ASL5ECL	End Cap w/Screws - Left		
ASL5ECR	End Cap w/Screws - Right		
ASL5ECLS	Inside Corner-Front In	10"	11 lbs
ASL5ECRS	Inside Corner-Bottom In	10"	11 lbs
ASL5ICF	Outside Corner-Front In	5"	7 lbs
ASL5ICB	Outside Corner-Bottom In	5"	7 lbs
ASL5OCF	135° Inside Corner-Front In	10"	11 lbs
ASL5OCB	135° Inside Corner-Bottom In	10"	11 lbs
ASL5135ICF	135° Outside Corner-Front In	5"	7 lbs
ASL5135ICB	135° Outside Corner-Bottom In	5"	7 lbs
ASL5135OCF	Dec. End Section-Bot. In, Left	12 1/2"	11 lbs
ASL5135OCB	Dec. End Section-Bot. In, Right		11 lbs
ASL5DESBL	Dec. End Section-Front In, Left		7 lbs
ASL5DESBR	Dec. End Section-Front In, Right		7 lbs
ASL5DESFL	Splice Plate	0-1/4"	1 lbs
ASL5DESFR	Filler Section 3 in.	0-3"	1 lbs
ASL5SP	Filler Section 6 in.	3-6"	1 lbs
ASL5FL3	Filler Section 9 in.	6-9"	2 lbs
ASL5FL6	Filler Section 12 in.	9-12"	3 lbs
ASL5FL9	Filler Section 18 in.	15-18"	5 lbs
ASL5FL12	Receptacle Section-Front In	4 1/2"	2 lbs
ASL5-FL18	Receptacle Section-Bottom In		
ASL5DRF	Standard Pedestal 4 1/8 in. (H)	-	2 lbs
ASL5DRB	Architectural Pedestal 4 1/8 in. (H)		
PK5S*	Stand-Off Bracket	-	1 lbs
PK5A*	Architectural Pedestal 2 1/8 in. (H)	-	2 lbs
SO1A	Stand-Off Bracket	-	1 lbs

*One pedestal. Two required on units up to 10 ft., three required on units over 10ft.

**Add suffix -P for painted, -C for clear anodized, -B for bronze anodized (excludes PK5S - Black only).

***All Stand-off Brackets come standard as Beige.

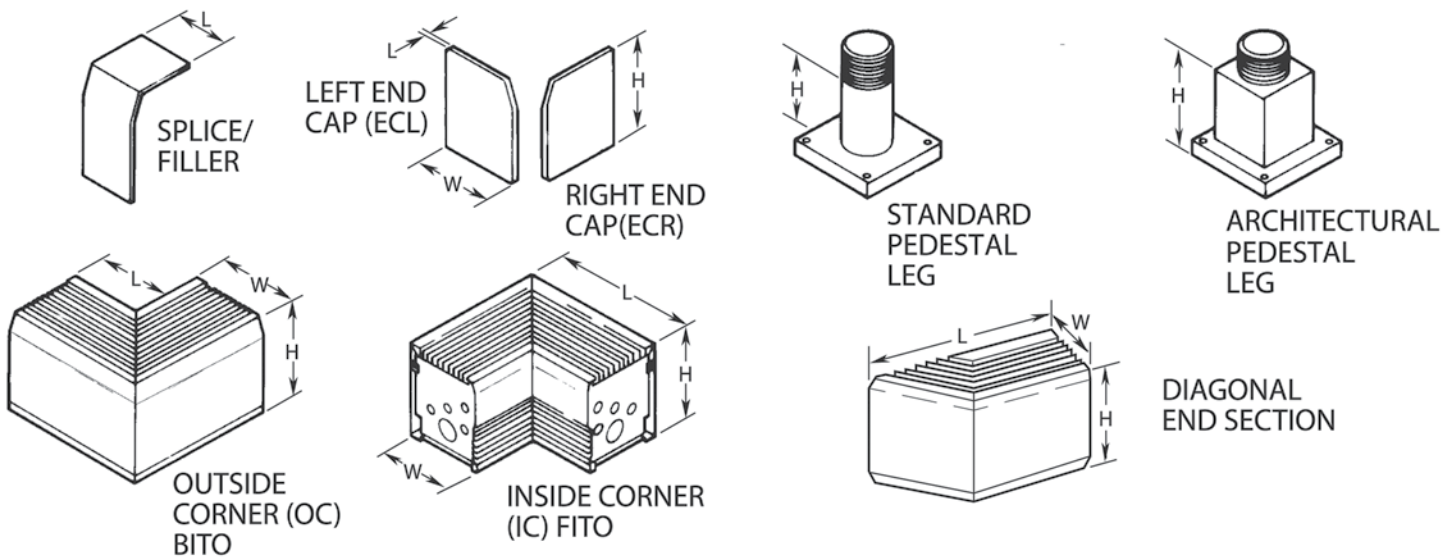

ASLC SERIES

Slimline Aluminum Convectors



Bottom inlet unit is only 2 ¾ in. wide by 6 in. tall. Can be mounted to wall (3 in. above floor) or in front of window mounted on pedestals.

Front inlet unit is only 2 ¾ in. wide by 6 in. tall. Can be mounted to wall or directly to floor.

Hollow pedestals are 3 in. tall and allow concealed wiring access when stubbed through concrete floors.

Slimline convectors provide warmth and draft protection with a design that sits **closer to the wall** for a less obtrusive solution that still provides **expansive airflow**. These units feature multiple heating configurations and other accessories, so you can tailor your output, aesthetics and controls to fit your needs.

Key Features:

Higher Heat Output

Slimline design fits a taller housing into a compact footprint for enhanced output that's useful for draft protection, supplemental or primary heating.

Multiple Configurations

Customize your convector to match the specific heating needs and dimensions of the surrounding environment, including continuous, mullion-to-mullion design that makes your heating system virtually invisible. Flexible heat output levels are available, and you can order the length, voltage and color you need to fit your room exactly.

Accessory Options

Blend your convector into your building's design to provide a symmetrical heating layout. Blank sections, fillers, corners and caps can be added to your convector for a more finished look that suits your room. With cutting up to 1/32 of an inch and mitered corners of up to 43°, Marley can provide wall-to-wall convectors based on your blueprints or even just a concept sketch.

Custom Colors

No need to repaint on-site. Provide your own sample color chip or select from a palette of standard and custom color options.

Ideal Spaces:

- Living Rooms
- Bedrooms
- Offices
- Hallways & Lobbies
- Condos
- Conference Rooms
- Retail Spaces
- Floor-to-Ceiling Curtain Walls

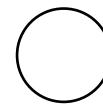

White

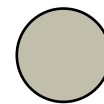

Beige

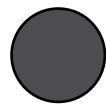

Charcoal Grey

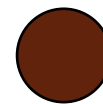

Bronze

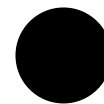

Black

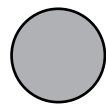

Aluminum



Custom and/or Anodized Colors also Available



Scan the QR code to access additional specs and features.

ASLC SERIES

Slimline Aluminum Convectector

Lengths

Length	2'	28"	3'	4'	5'	6'
Shipping Weight	8 lbs	8 lbs	10 lbs	13 lbs	17 lbs	20 lbs

NOTE: Additional cabinet sizes available up to 12 ft. length. Backs are provided standard with no finish. For finished backs, add 10% to list price. Knockouts on back omitted by request only. All models are non-stock, made-to-order. Consult sales representative for more information on specs and lead times.

Watts per Ft.*

100	125	150
188	250	

Voltages*

120	208	240
277	347	600

*Specs vary by length. Refer to the submittal sheet for full details.

Blank Section & Accessories:

CATALOG NO.	DIMENSIONS (W x H x L)	INLET	SHIP WT.
SLCBS1F	2 ¾" x 6" x 1'	Front	4 lbs
SLCBS1B		Bottom	
SLCBS2F	2 ¾" x 6" x 28"	Front	7 lbs
SLCBS2B		Bottom	
SLCBS3F	2 ¾" x 6" x 3'	Front	9 lbs
SLCBS3B		Bottom	
SLCBS4F	2 ¾" x 6" x 4'	Front	12 lbs
SLCBS4B		Bottom	
SLCBS5F	2 ¾" x 6" x 5'	Front	16 lbs
SLCBS5B		Bottom	
SLCBS6F	2 ¾" x 6" x 6'	Front	19 lbs
SLCBS6B		Bottom	

NOTE: Blank section grilles are not punched unless requested. Additional sections available for cabinets up to 12 ft. length.

CATALOG NO.	DESCRIPTION	ADDITIONAL SPACE REQUIRED	SHIP WT.
SLCECL	End Cap - Left	½"	1 lbs
SLCECR	End Cap - Right	½"	1 lbs
SLCICF	Inside Corner-Front In	8 ½"	5 lbs
SLCICB	Inside Corner-Bottom In	8 ½"	5 lbs
SLCOCF	Outside Corner-Front In	5"	4 lbs
SLCOCB	Outside Corner-Bottom In	5"	4 lbs
SLCDESBL	Dec. End Section-Bottom In, Left	9 ¾"	5 lbs
SLCDESBR	Dec. End Section-Bottom In, Right	9 ¾"	5 lbs
SLCDESFL	Dec. End Section-Front In, Left	9 ¾"	4 lbs
SLCDESFR	Dec. End Section-Front In, Right	9 ¾"	4 lbs
SLCSP	Splice Plate	0-¼"	1 lbs
SLCFL3	Filler Section 3 in.	0-3"	1 lbs
SLCFL6	Filler Section 6 in.	3-6"	1 lbs
SLCFL9	Filler Section 9 in.	6-9"	1 lbs
SLCFL12	Filler Section 12 in.	9-12"	1 lbs
SLCFL18	Filler Section 18 in.	12-18"	1.5 lbs
SLCFL24	Filler Section 24 in.	18-24"	1.5 lbs
SLCDRF	Receptacle Section-Front In	4 ½"	1.5 lbs
SLCDRB	Receptacle Section-Bottom In	4 ½"	1.5 lbs
SLCPEF	Pneu/Ele Sw-Front In	4 ½"	2 lbs
SLCPFB	Pneu/Ele Sw-Bot. In	4 ½"	2 lbs
SLCPK3A**	Architectural Pedestal	-	2 lbs
SO1A***	Stand-Off Bracket	-	1 lbs

*Add suffix -P for painted, -C for clear anodized, -B for bronze anodized. **One pedestal. Two pedestals required on units up to 10 ft. and three required on units over 10 ft. ***Beige is standard.

Optional Built-In Controls:

Suffix*	OPTIONAL BUILT-IN CONTROLS	USE CASE(S)	RATINGS & DESCRIPTIONS
T	Single-Pole Thermostat	Ideal for 120v and 277v heaters	Rated 25 amps @ 120-240 VAC and 22 amps @ 277 VAC. Pilot duty rating of 125 VA (all voltages) 60-120°F temperature range adjustable through outlet grille-tamper-resistant. (See Note B)
2T	Double-Pole Thermostat	Ideal for 208v and 240v heaters	Rated 25 amps @ 120-240 VAC and 22 amps @ 277 VAC. Pilot duty rating of 125 VA (all voltages). 60-120°F temperature range adjustable through outlet grille-tamper-resistant. (See Note B for amperage restrictions)
DS	Power On/Off Switch	Ideal for servicing	Double-pole, rated 20 amp @ 120-277 VAC. (See Note A.) For heaters over 20 amps specify two
TR**	Transformer Relay	Ideal for remote, low voltage thermostats	Single-pole, low voltage relay with built-in transformer (24 VAC control), rated 22 amps @ 120-240 VAC and 22 amps @ 277 VAC. (See Note E and F) 17 amps @ 347V. Not available for three-phase heaters
PR	Power Relay	Ideal for multiple heater connections or BMS / EMS connections	Single-pole magnetic relay, rated 25 amps @ 120-600 VAC. (See Note E). Specify control voltage
PDT	Single-Pole Thermostat	For sequencing low voltage connections with a transformer relay	Same as -T except Pilot Duty. (See Note C)
R**	Receptacle	For additional electrical connections.	For built-in or as installed in a control section

* Addition To Basic Catalog No. (See Note D)

** Will add 4 in. to length of heater. (A) For single-phase loads over 20A, specify (2) power on/off switches. (B) This control option is not available on single-phase heaters over 25 amps (22 amps on 277 VAC). In combination with the power on/off switch option use the 2T thermostat option on heaters over 20 amps. (C) Requires PR or TR. (D) Up to 30 power relays in different heaters can be controlled by each stage of a two-stage pilot duty thermostat. (E) Two relays are required on single-phase heaters over 20 amps with a disconnect switch, over 25 amps without a disconnect switch. (F) For ASLC Series the TR (transformer relay) R (Duplex Receptacle) will be installed in separate 4 in. long internal control boxes.

BDBSL SERIES

Draft Barrier Convectors



Bottom inlet unit is only 2 3/4 in. wide by 4 in. tall. Can be mounted to wall (2 in. above floor) or in front of window mounted on pedestals.



Hollow pedestals are 3 in. tall and allow concealed wiring access when stubbed through concrete floors.

Keep your windows **free from condensation and drafts** with reliable aluminum draft barrier convectors. Their **low-profile design provides an unobtrusive heating solution** that can be seamlessly added to any wall space. With multiple configurations and accessory options, you're sure to get just what you need.

Key Features:

Multiple Configurations

Customize your convector to match the specific heating needs and dimensions of the surrounding environment, including continuous, mullion-to-mullion design that makes your heating system virtually invisible. Flexible heat output levels are available, and you can order the length, voltage and color you need to fit your room exactly.

Accessory Options

Blend your convector into your building's design to provide a symmetrical heating layout. Blank sections, fillers, corners and caps can be added to your convector for a more finished look that suits your room. With cutting up to 1/32 of an inch and mitered corners of up to 43°, Marley can provide wall-to-wall convectors based on your blueprints or even just a concept sketch

2-Piece Extruded Aluminum Construction

For rapid installation and easy maintenance, these extruded aluminum convectors feature a simple, two-piece design. The "Snap-Lock" closure allows you to easily secure the two pieces with no need for other fasteners.

Easy Service/Installation

Make routine maintenance faster and easier with a draft barrier convector. It is pre-wired for entry on the right or left, with identical junction boxes on both ends. The power supply can be connected from the bottom, the rear or either end for easy wiring of multiple units from one point

Ideal Spaces:

- Living Rooms
- Bedrooms
- Offices
- Hallways & Lobbies
- Condos
- Conference Rooms
- Retail Spaces
- Floor-to-Ceiling Curtain Walls

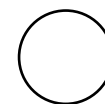

White

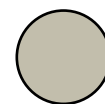

Beige

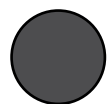

Charcoal Grey

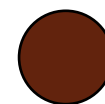

Bronze



Black

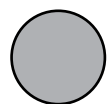

Aluminum



Custom and/or Anodized Colors also Available



Scan the QR code to access additional specs and features.

BDBSL SERIES

Draft Barrier Convectors

Lengths

Length	2'	28"	3'	4'	5'	6'
Shipping Weight	8 lbs	8 lbs	10 lbs	13 lbs	17 lbs	20 lbs

NOTE: Cabinet available up to 12 ft. length. Custom length cabinets are priced with heater and blank to the next larger size. Backs are provided standard with no finish. For finished backs, add 10% to list price. Knockouts on back omitted by request only. All models are NON-STOCK made-to-order. When ordering, specify quantity, catalog number, voltage, wattage, optional controls, and color. Consult sales representative for lead times.

Watts per Ft.*

100	125
150	

Voltages*

120	208	240
277	347	600

*Specs vary by length. Refer to the submittal sheet for full details.

Optional Accessories:

CATALOG NO.	DIMENSIONS (W x H x L)	SHIP WT.
SLDBS1B	2 5/8" x 4" x 2'	4 lbs
SLDBS2B	2 5/8" x 4" x 28"	7 lbs
SLDBS3B	2 5/8" x 4" x 3'	9 lbs
SLDBS4B	2 5/8" x 4" x 4'	12 lbs
SLDBS5B	2 5/8" x 4" x 5'	16 lbs
SLDBS6B	2 5/8" x 4" x 6'	19 lbs

NOTE: Blank section grilles are not punched unless requested. Additional sections available for cabinets up to 12 ft. length.

CATALOG NO.	DESCRIPTION	ADDITIONAL SPACE REQUIRED	SHIP WT.
SLDECL	End Cap - Left	1/8"	1 lbs
SLDECR	End Cap - Right	1/8"	1 lbs
SLDICB	Inside Corner-Bottom In	8-1/2"	5 lbs
SLDOCB	Outside Corner-Bottom In	8-1/2"	5 lbs
SLDI35ICB	135° Inside Corner-Bottom In	5"	4 lbs
SLDI35OCB	135° Outside Corner-Bottom In	5"	4 lbs
SLDSP	Splice Plate	0-1/4"	1 lbs
SLDFL3	Filler Section 3 in.	0-3"	1 lbs
SLDFL6	Filler Section 6 in.	3-6"	1 lbs
SLDFL9	Filler Section 9 in.	6-9"	1 lbs
SLDFL12	Filler Section 12 in.	9-12"	1 lbs
SLDFL18	Filler Section 18 in.	12-18"	1.5 lbs
SLDFL24	Filler Section 24 in.	18-24"	1.5 lbs
SLDRB	Receptacle Section-Bottom In Must use 1 ft. Blank Section	12"	2 lbs
SLDPK3A**	Architectural Pedestal	-	2 lbs
SO1A***	Stand-Off Bracket	-	1 lbs

* Add suffix -P for painted, -C for clear anodized, -B for bronze anodized.

** One pedestal. Two pedestals required on units up to 10 ft. and three required on units over 10 ft.

*** All Stand-off Brackets come standard as Beige.

Optional Built-In Controls:

Suffix*	OPTIONAL BUILT-IN CONTROLS	USE CASE(S)	RATINGS & DESCRIPTIONS
T	Single-Pole Thermostat	Ideal for localized control	Rated 24 amps @ 120-240 VAC and 22 amps @ 277 VAC. Pilot duty rating of 125 VA (all voltages). 60-120°F temperature range; adjustable through outlet grille-tamper-resistant. (See Note B) Not available on three-phase heaters.
DS	Power On/Off Switch	Ideal for servicing	Double-pole, rated 20 amp @ 120-277 VAC. (See Note A) For three-phase heaters and single-phase heaters over 20 amps specify two.
PR	Power Relay	Ideal for multiple heater connections or BMS / EMS connections	Single-pole magnetic relay, rated 18 amps @ 120-600 VAC. (See Note C) Specify control voltage. Rated 24 amps @ 120-240 VAC and 22 amps @ 277 VAC. Pilot duty rating of 125 VA — all voltages (See Note C & D)

* Addition To Basic Catalog No. (See Note D)

NOTE: A. For single-phase loads over 20A and all three-phase loads, specify (2) power on/off switches. B. This control option is not available on single-phase heaters over 24 amps (22 amps on 277 VAC). C. Specify holding coil voltage where applicable. D. Add 4 in. to the cabinet length.

CPL SERIES

Decorative Pedestal Steel Convectors

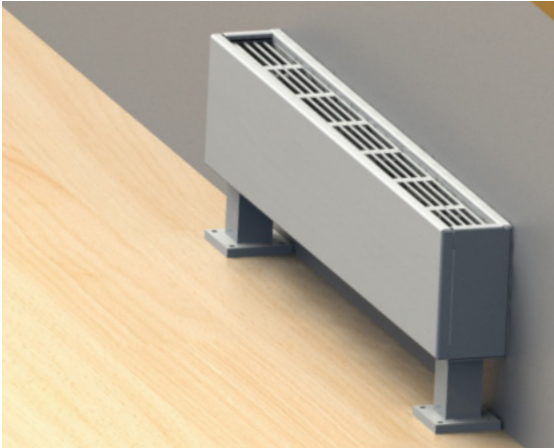

CPH

For hallways, terminals and conference spaces, steel commercial convectors provide a **reliable draft barrier** and heating solution. Available with a full length decorative grille, this pedestal-mounted heater features **multiple lengths and output levels** to best address your heating needs.

Key Features:

Multiple Configurations

Configure your convector to match the specific heating needs and dimensions of your space. Select your heat output level with either single or up to three stacked heat elements. Order the length, voltage and color you need to fit your room exactly.

Higher Heat Output

Increase your heating capacity for cold spots or isolated areas. Up to 3 stacked heating elements expand your output to provide quiet, reliable heat for larger commercial spaces.

Accessory Options

Blend your convector into your building's design to provide a cohesive solution. Blank sections, fillers, corners and caps can be added to your convector for a more finished look that suits your space.

Built-In Control Options

Get the accurate controls you need, pre-installed. You can order anything from a simple on/off switch to a thermostat, transformer or power relay.

Custom Colors

No need to repaint on-site. Provide your own sample color chip or select from a palette of standard and custom color options.



Scan the QR code to access additional specs and features.

Ideal Spaces:

- Offices
- Hallways
- Lobbies
- Retail Spaces
- Terminals
- Commercial / Institutional Spaces with Floor-to-Ceiling Windows

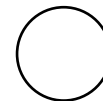

White

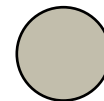

Beige



Charcoal Grey

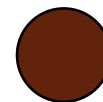

Bronze



Black

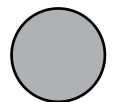

Aluminum



Custom color also available

CPL SERIES

Decorative Pedestal Steel Convectors

5 1/2" x 3" – Single Element

Lengths

Length	28"	3'	4'	5'	6'	8'	10'
Shipping Weight	11 lbs	15 lbs	18 lbs	25 lbs	29 lbs	38 lbs	47 lbs

NOTE: All models are NON-STOCK, MADE-TO-ORDER. When ordering, specify quantity, catalog number, voltage, wattage, optional controls, and color. Consult sales representative for lead times.

Watts per Ft.*

125	188
250	

Voltages*

120	208	240
277	347	600

*Specs vary by length. Refer to the submittal sheet for full details.

7" x 5" – Multiple Elements

Available Length

Length	28"	3'	4'	5'	6'	8'	10'
Shipping Weight	11 lbs	15 lbs	18 lbs	25 lbs	29 lbs	38 lbs	47 lbs

NOTE: All models are NON-STOCK, MADE-TO-ORDER. When ordering, specify quantity, catalog number, voltage, wattage, optional controls, and color. Consult sales representative for lead times.

Watts per Ft.*

1 Element*	125	188	250
2 Elements*	375	500	
3 Elements*	564	625	750

Voltages*

Single Phase*	208	240	277
	347	600	
Three Phase*	208	240	600

*Specs vary by length. Refer to the submittal sheet for full details.

Optional Accessories:

CATALOG NO.	DESCRIPTION	COMPATIBLE WITH	SHIP WT.	
BLANK SECTIONS	CPLASBL21	CPLASA Heaters	10 lbs	
	CPLASBL31		13 lbs	
	CPLASBL41		17 lbs	
	CPLASBL51		21 lbs	
	CPLASBL61	CPLSA Heaters	25 lbs	
			CPLASBL81	32 lbs
			CPLASBL101	42 lbs
	CPLAMBL21	CPLAM Heaters	14 lbs	
			CPLAMBL31	18 lbs
			CPLAMBL41	24 lbs
			CPLAMBL51	30 lbs
	CPLAMBL61	CPLAM Heaters	36 lbs	
CPLAMBL81			48 lbs	
CPLAMBL101			60 lbs	
PEDESTAL LEG KITS	CPLASPD2	Legs must be ordered with CPLSA Heaters/Blanks	3 lbs	
	CPLASPD3		4 lbs	
	CPLASPD4		5 lbs	
	CPLAMPD2	Legs must be ordered with CPLAM Heaters/Blanks	4 lbs	
	CPLAMPD3		5 lbs	
	CPLAMPD4		7 lbs	
END CAPS	RIGHT	CPLSA/CPLAM Heaters/Blanks	1 lbs	
	CSLASECR1		1 lbs	
	LEFT	CPLSA/CPLAM Heaters/Blanks	1 lbs	
	CSLAMECL1		1 lbs	

All steel convectors come standard with end caps. All pedestal style steel convectors come standard with pedestals. Outlet Mesh: Price per foot. 14-Gauge Front Cover: add 10% to heater price. Standard color included in base price. Other colors available. See paint policy page for information on custom paint colors. If color is not specified, front covers will be Beige. Back, grille, and accessories will be statuary bronze. When ordering, specify heater catalog number, voltage, phase, suffix catalog number for built-in controls, color, and options. Specify color for pedestal legs.

See Convector Heater Controls page for Optional Controls.

CSL SERIES

Decorative Sill-Height Steel Convectors



Add a **designer touch** to retail spaces, offices and lobbies with a decorative steel convector. Featuring the same heating levels and available options as the standard commercial steel convector, this model also offers a **full-length louvered grille design** that creates a striking accent wherever it's installed.

Key Features:

Decorative Grille

Create a more seamless sight line with decorative steel convectors. Their uninterrupted full-length louvers provide a designer accent to complement your room design.

Multiple Configurations

Configure your convector to match the specific heating needs and dimensions of your space. Select your heat output level with either single or up to three stacked heat elements. Order the length, voltage and color you need to fit your room exactly.

Higher Heat Output

Increase your heating capacity for cold spots or isolated areas. Up to three stacked heating elements expand your output to provide quiet, reliable heat for larger spaces

Accessory Options

Blend your convector into your building's design to provide a cohesive solution. Blank sections, fillers, corners and caps can be added to your convector for a more finished look that suits your space.

Ideal Spaces:

Offices
Hallways
Lobbies
Retail Spaces
Terminals
Commercial /
Institutional Spaces with
Floor-to-Ceiling Windows

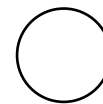

White

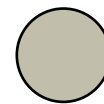

Beige

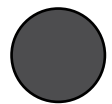

Charcoal Grey

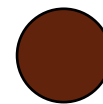

Bronze



Black

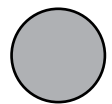

Aluminum



Custom and/or Anodized
Colors also Available



**Scan the QR code to access
additional specs and features.**

CSL SERIES

Decorative Sill-Height Steel Convectors

5 1/2" x 3" – Single Element

Lengths

Length	28"	3'	4'	5'	6'	8'	10'
Shipping Weight	11 lbs	15 lbs	18 lbs	25 lbs	29 lbs	38 lbs	47 lbs

NOTE: All models are NON-STOCK, MADE-TO-ORDER. When ordering, specify quantity, catalog number, voltage, wattage, optional controls, and color. Consult sales representative for lead times.

Watts per Ft.*

125	188
250	

Voltages*

120	208	240
277	347	600

*Specs vary by length. Refer to the submittal sheet for full details.

7" x 5" & 14" x 5" – Multiple Elements

Lengths

Length		28"	3'	4'	5'	6'	8'	10'
Shipping Weight	7" x 5"	17 lbs	21 lbs	28 lbs	35 lbs	42 lbs	56 lbs	70 lbs
	14" x 5"	25 lbs	32 lbs	42 lbs	53 lbs	60 lbs	80 lbs	100 lbs

NOTE: All models are NON-STOCK, MADE-TO-ORDER. When ordering, specify quantity, catalog number, voltage, wattage, optional controls, and color. Consult sales representative for lead times.

Watts per Ft.*

1 Element*	125	188	250
2 Elements*	375	500	
3 Elements*	564	625	750

Voltages*

Single Phase*	208	240	277
	347	600	
Three Phase*	208	240	600

*Specs vary by length. Refer to the submittal sheet for full details.

Optional Accessories:

CATALOG NO.	COMPATIBLE WITH	HEIGHT	DEPTH	LENGTH	SHIP WT.
CSLASBL2	CSLAS	5 1/2"	3"	28"	10 lbs
CSLASBL3				3'	13 lbs
CSLASBL4				4'	17 lbs
CSLASBL5				5'	21 lbs
CSLASBL6				6'	25 lbs
CSLASBL8				8'	32 lbs
CSLASBL10				10'	42 lbs
CSLAMBL2	CSLAM	7"	5"	28"	14 lbs
CSLAMBL3				3'	18 lbs
CSLAMBL4				4'	24 lbs
CSLAMBL5				5'	30 lbs
CSLAMBL6				6'	36 lbs
CSLAMBL8				8'	48 lbs
CSLAMBL10				10'	60 lbs
CSLALBL2	CSLAL	14"	5"	28"	22 lbs
CSLALBL3				3'	29 lbs
CSLALBL4				4'	38 lbs
CSLALBL5				5'	48 lbs
CSLALBL6				6'	57 lbs
CSLALBL8				8'	76 lbs
CSLALBL10				10'	95 lbs

Outlet Mesh: Price per foot. 14-Gauge Front Cover; add 10% to heater price. Standard color included in base price. Other colors available. See paint policy page for information on custom paint colors. Maximum of 250 watts per ft. on front outlet models. When ordering, specify heater catalog number, voltage, phase, suffix catalog number for built-in controls, color, and options. 2. If color is not specified, front covers will be Beige. Front outlet models available only in 14 in. height and 125, 188 and 250 Wt./Ft. configuration. Outlet mesh is not available on front outlet models.

*Additional length the accessory adds to the total installation length. **Built-in duplex receptacle available. Add model numbers suffix "-1" for bottom inlet - top outlet; add suffix "-3" for bottom inlet - front outlet.

Dimensions and Clearances:

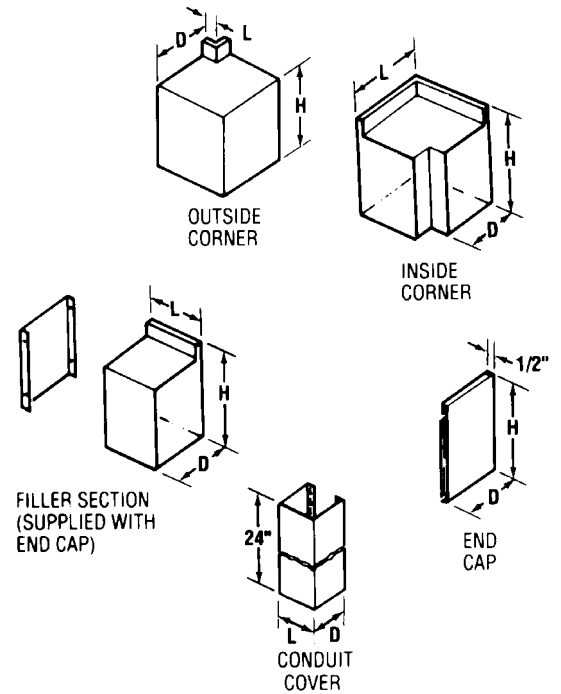

Optional Accessories:

CATALOG NO.		COMPATIBLE WITH	HEIGHT	DEPTH	LENGTH	ADDITIONAL LENGTH	SHIP WT.	
END CAPS	LEFT	CSLASECL**	CSLAS	5 ½"	2 ½"	-	1/8"	1 lbs
		CSLAMECL**	CSLAM	7"	4 ¼"			1 lbs
		CSLASECL**	CSLAL	14"	4 ¼"			1 lbs
	RIGHT	CSLASECR**	CSLAS	5 ½"	2 ½"	-	1/8"	1 lbs
		CSLAMECR**	CSLAM	7"	4 ¼"			1 lbs
		CSLASECR**	CSLAL	14"	4 ¼"			1 lbs
FILLER SECTIONS	CSLASFL3	CSLAS	5 ½"	5 ½"	4	0-3	1 lbs	
	CSLAMFL3	CSLAM	7"	6 ½"			2 lbs	
	CSLALFL3	CSLAL	14"	13 ½"			3 lbs	
	CSLASFL6**	CSLAS	5 ½"	2 ½"	7	3-6	2 lbs	
	CSLAMFL6**	CSLAM	6 ½"	4 ½"			3 lbs	
	CSLALFL6**	CSLAL	13 ½"	4 ½"			5 lbs	
	CSLASFL9**	CSLAS	5 ½"	2 ½"	10	6-9	3 lbs	
	CSLAMFL9**	CSLAM	6 ½"	4 ½"			4 lbs	
	CSLALFL9**	CSLAL	13 ½"	4 ½"			6 lbs	
	CSLASFL12**	CSLAS	5 ½"	2 ½"	13	9-12	4 lbs	
	CSLAMFL12**	CSLAM	6 ½"	4 ½"			5 lbs	
	CSLALFL12**	CSLAL	13 ½"	4 ½"			8 lbs	
	CSLASFL18**	CSLAS	5 ½"	2 ½"	19	15-18	5 lbs	
	CSLAMFL18**	CSLAM	6 ½"	4 ½"			6 lbs	
	CSLALFL18**	CSLAL	13 ½"	4 ½"			9 lbs	
CORNERS	INSIDE	CSLASIC	CSLAS	5 ½"	2 ½"	4 ½"	3-3 ½"	2 lbs
		CSLAMIC	CSLAM	6 ½"	4 ½"	6"	5-5 ½"	4 lbs
		CSLALIC	CSLAL	13 ½"	4 ½"	6"	5-5 ½"	6 lbs
	OUTSIDE	CSLASOC	CSLAS	5 ½"	2 ½"	1"	0-½"	1 lbs
		CSLAMOC	CSLAM	6 ½"	4 ½"			2 lbs
		CSLALOC	CSLAL	13 ½"	4 ½"			4 lbs
	CONDUIT	CSLASCC	CSLAS	-	2 5/8"	2 ½"	-	4 lbs
		CSLAMCC	CSLAM	-	-	-	-	5 lbs
	STAND-OFF BRACKETS	SO1	CSLAS	4 ¾"	¾"	3"	-	1 lbs
SO2		CSLAM	6 ¾"	¾"	3"	-	1 lbs	

All steel convectors come standard with end caps. All pedestal style steel convectors come standard with pedestals. Outlet Mesh: Price per foot. 14-Gauge Front Cover: add 10% to heater price. Standard color included in base price. Other colors available. See paint policy page for information on custom paint colors. Maximum of 250 watts per ft. on front outlet models. When ordering, specify heater catalog number, voltage, phase, suffix catalog number for built-in controls, color, and options. 2. If color is not specified, front covers will be Beige. Front outlet models available only in 14 in. height and 125, 188 and 250 Wt./Ft. configuration. Outlet mesh is not available on front outlet models.

*Additional length the accessory adds to the total installation length. **Built-in duplex receptacle available. Add model numbers suffix "-1" for bottom inlet - top outlet; add suffix "-3" for bottom inlet - front outlet.

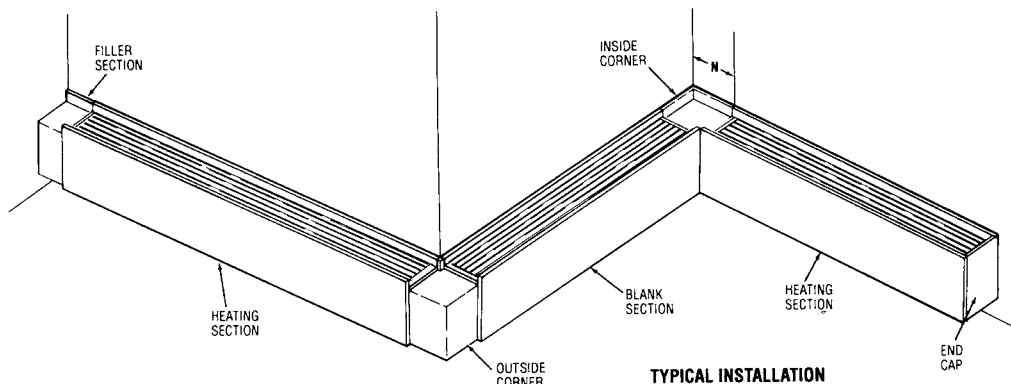

UCJ SERIES

Institutional Electric Convector

CONVECTORS
MARLEY CUSTOM CAPABILITIES

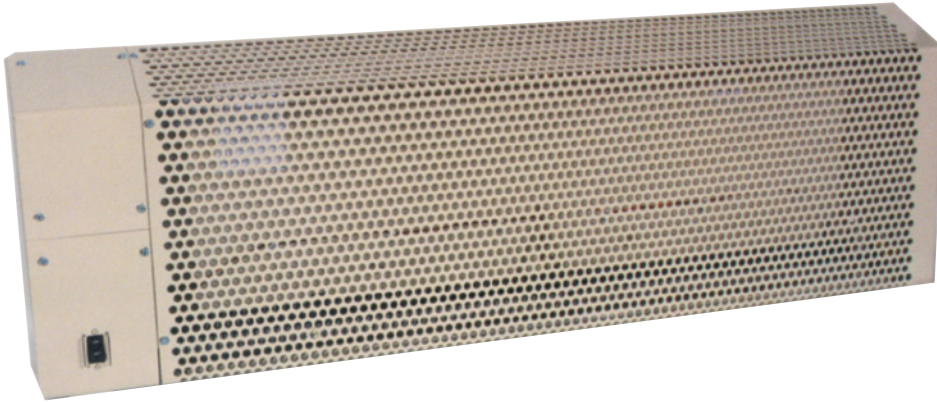

When you need a durable, reliable heating solution with a **low surface temperature**, choose an institutional convector. It's perfect for **high-traffic areas** like hallways, classrooms, libraries and municipal buildings.

Key Features:

Durable Design

Keep hallways and public areas cozy without worrying about your heater getting dented or damaged. This convector is built to endure high-traffic areas with its high-gauge steel cabinet and epoxy-painted coating.

Tamper-Resistant

Keep live voltage away from passersby. The internally secured control box keeps the power supply and wiring for the unit safe from unauthorized access.

Keep Your Intakes Clear

For unrestricted airflow at all times, choose institutional convectors. The top of the unit is sloped at a 45° angle to keep people or objects from accidentally covering the vents.

Cooler to the Touch

Heat the room, not the heater itself. A taller housing allows this unit to operate at a lower surface temperature, so it's cooler to the touch. This allows for safer heating in any room.

Open Airflow

Enjoy efficient, worry-free heating, thanks to this unit's perforated steel front. This design maximizes airflow while providing a lower surface temperature that's safer to the touch.

Technical Specifications:

Construction: 12 gauge Steel

DPST Thermostat Range:

55°-100° F

Ideal Spaces:

Offices
Conference Rooms
Hallways
Lobbies
Waiting Rooms
Common Areas

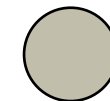

Beige



Scan the QR code to access additional specs and features.

UCJ SERIES

Institutional Electric Convector

Models & Specifications:

CATALOG NO.	ELECTRICAL DATA			SHIP WT.
	VOLTS	WATTS (K/W)	AMPS	
UCJ400	120	400	3.3	40 lbs
UCJ408	208		1.9	
UCJ404	240		1.7	
UCJ407	277		1.4	
UCJ500	120	500	4.2	45 lbs
UCJ508	208		2.4	
UCJ504	240		2.2	
UCJ507	277		1.8	
UCJ750	120	750	6.3	55 lbs
UCJ758	208		3.6	
UCJ754	240		3.3	
UCJ757	277		2.7	
UCJ753	347		2.2	
UCJ1000	120	1000	8.3	65 lbs
UCJ1008	208		4.8	
UCJ1004	240		4.4	
UCJ1007	277		3.6	
UCJ1003	347		2.9	
UCJ1006	600		1.7	
UCJ1250	120	1250	10.4	80 lbs
UCJ1258	208		6	
UCJ1254	240		5.4	
UCJ1257	277		4.5	
UCJ1253	347		3.6	
UCJ1256	600	2.1		
UCJ1500	120	1500	12.5	95 lbs
UCJ1508	208		7.2	
UCJ1504	240		6.5	
UCJ1507	277		5.4	
UCJ1503	347		4.3	
UCJ1506	600		2.5	
UCJ2008	208	2000	9.6	
UCJ2004	240		8.8	
UCJ2007	277		7.2	
UCJ2003	347		5.8	
UCJ2006	600		3.3	

SKU Legend: ■ = Made to Order (Contact your local Marley Sales Representative for typically associated lead times)

Dimensions and Clearances:

WATTS	LENGTH (A)	HEIGHT	DEPTH
400	24"	16"	5"
500	28"	16"	5"
750	36"	16"	5"
1000	48"	16"	5"
1250	60"	16"	5"
1500	72"	16"	5"
2000	96"	16"	5"

NOTE: Products are made-to-order and cannot be returned.

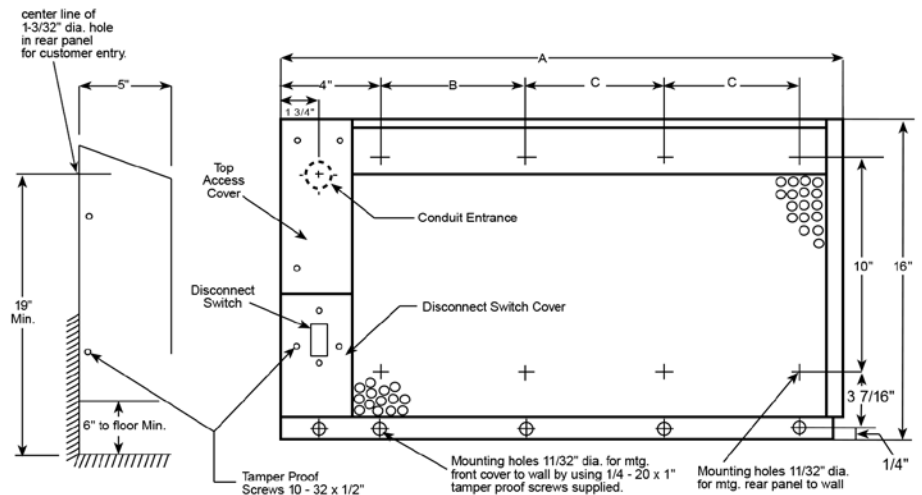

ICST SERIES

Commercial Slope-Top Steel Convectors

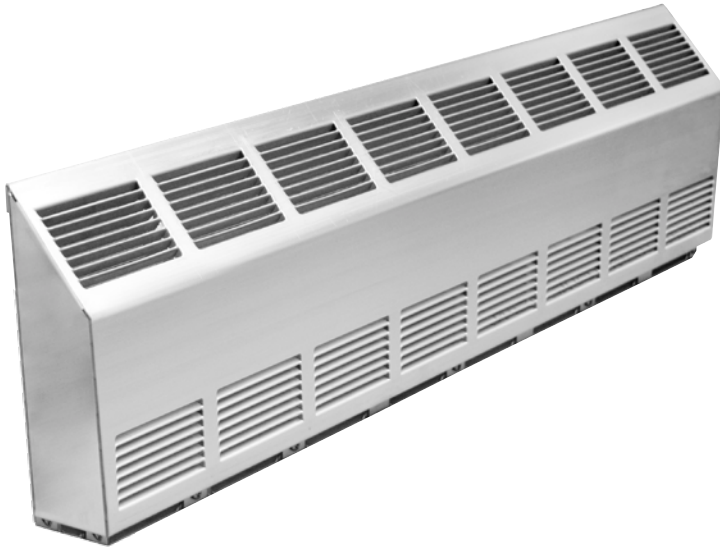

A rugged comfort solution for offices, lobbies or stairwells, this Commercial Slope-Top Convector provides higher heat output with multiple configurations available. Its slope-top design **protects vital airflow** from obstructions, while its heavy-duty steel construction **resists dings and dents**. NEMA 4X models are available for **wet or corrosive environments** like food processing areas, breweries, wastewater treatment plants and swimming pools.

Key Features:

Multiple Configurations

Configure your convector to match the specific heating needs and dimensions of your space. Select your heat output level, length, voltage and color. Stainless steel units are also available.

Higher Heat Options

Increase your heating capacity for cold spots or isolated areas. Anchored metal-sheath elements provide quiet, reliable heat with expanded output to warm larger commercial spaces

Accessory Options

Blend your convector into your building's design to provide a cohesive solution. Blank sections, fillers and corners can be added to your convector for a more finished look that suits your space

Built-In Control Options

Get the accurate controls you need, pre-installed. You can order anything from a simple on/off switch to a thermostat, transformer or power relay

High-Grade Construction Option

For safe, reliable heat in damp or corrosive environments, select a commercial slope-top convector. Available in 16-gauge stainless steel with a NEMA 4X thermostat to protect wiring and controls.



Scan the QR code to access additional specs and features.

Ideal Spaces:

Offices
Hallways
Lobbies
Stairwells

NEMA 4X Models:

Food Processing Areas
Breweries
Wastewater Treatment Plants
Swimming Pools.

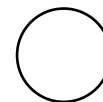

White

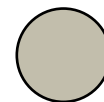

Beige



Charcoal Grey

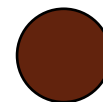

Bronze



Black

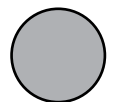

Aluminum



Custom Colors
also available

ICST SERIES

Commercial Slope-Top Steel Convectors

Lengths

Length	28"	3'	4'	5'	6'	8'	10'
Shipping Weight	12 lbs	15 lbs	19 lbs	24 lbs	26 lbs	37 lbs	45 lbs

Watts per Ft.*

125	188
250	

Voltagess*

120	208	240
277	347	600

*Specs vary by length. Refer to the submittal sheet for full details.

Optional Accessories:

SUFFIX*	Optional Built-In Controls	USE CASE(S)	RATINGS & DESCRIPTION
T*	Single-Pole Thermostat	Ideal for 120v and 277v heaters	Rated 25 amps @ 120-240 VAC and 22 amps @ 277 VAC. Pilot duty rating of 125 VA (all voltages). 60-120°F temperature range; adjustable through outlet grille-tamper-resistant
2T*	Double-Pole Thermostat	Ideal for 208v and 240v heaters	Rated 25 amps @ 120-240 VAC and 22 amps @ 277 VAC. Pilot duty rating of 125 VA (all voltages). 60-120°F temperature range; adjustable through outlet grille-tamper-resistant. (See Note 1 for amperage restrictions.)
DS*	Power On/Off Switch	Ideal for servicing	Double-pole, rated 20 amp @ 120-277 VAC
TR*	Transformer Relay	Ideal for remote, low voltage thermostats	Single-pole, low voltage relay with built-in transformer (24 VAC control). Rated 22 amps @ 120-240 VAC and 19 amps @ 277 VAC. 18 amps @ 347V. Not available on 3-phase heaters
PR*	Power Relay	Ideal for multiple heater connections or BMS / EMS connections	Single-pole magnetic relay, rated. (See Note 3) Specify control voltage. Rated 30 amps @ 120-240 VAC and 30 amps @ 277 VAC. Pilot duty rating of 125 VA — all voltages (See Note 3)
ICSTIC	2	-	Inside corner (requires additional wall space — use with ICST model only)
ICSTOC	2	-	Outside corner (requires additional wall space — use with ICST model only)
ICSTJS	1	-	Splice plate wide, coverage gap up to 1/2 in. (use with ICST model only)
STO2BS	-	-	2 ft. Blank Section (unheated section)
STO4BS	-	-	4 ft. Blank Section (unheated section)
STO6BS	-	-	6 ft. Blank Section (unheated section)
STO8BS	-	-	8 ft. Blank Section (unheated section)

*Addition To Basic Catalog No. (See Note D)

NOTE: For 347V and 600V units options T, 2T, DS, are not available. Specify PDT as the suffix for a thermostat. *Factory built-in. Add suffix to heater catalog number. 1) A control combination is not available on heaters that have an amperage draw which exceeds the rated limit of the lowest rated control. 2) For non-standard controls or combinations, contact factory. 3) Specify holding coil voltage where applicable.

NEMA 4X NOTE: Optional built-in controls are not compatible with the NEMA 4X Series. Standard 50 day lead time for NEMA 4X models. Contact sales representative for more information on NEMA 4X models. No built-in control option available on NEMA 4X models

Dimensions and Clearances:

WATTS	A	B	NO. OF HOLES
500	28"	-	-
750	36"	-	-
1000	48"	19"	2
1250	60"	16.68"	4
1500	72"	20.63"	4
2000	96"	21.5"	6
2500	120"	27.5"	6

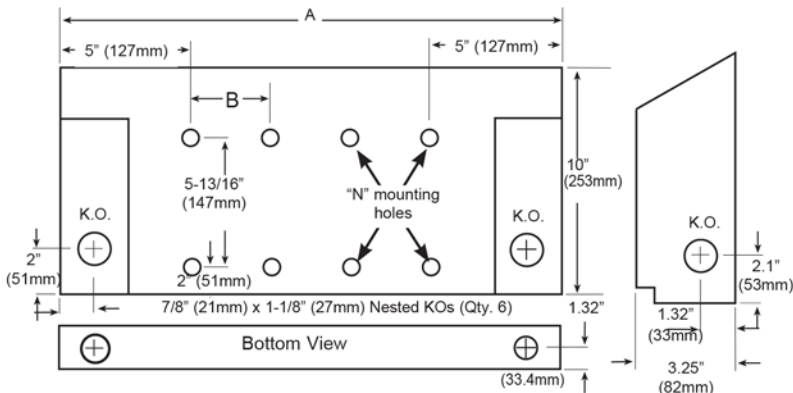

Nema 4x Model Stainless Steel

When failure is NOT an option

HAZARDOUS ENVIRONMENT PRODUCTS
MARLEY CUSTOM CAPABILITIES

Explosion-proof heaters are ideal for hazardous environments where the presence of flammable gases, vapor or dust exist.

BWD

Water Resistant Construction for Easy Cleaning

NEMA 4 box to protect controls

Epoxy coating available for corrosion resistance



RUX

Explosion proof for heat-sensitive areas

High-temp limit devices to avoid over temp situations

Motor is thermally protected and permanently lubricated

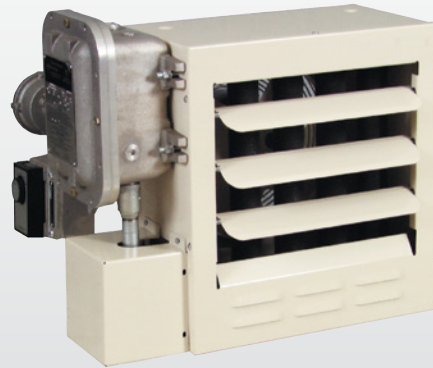

SCG

Explosion proof for heat-sensitive areas

High-temp limit devices to avoid over temp situations

Low-maintenance construction with no moving parts

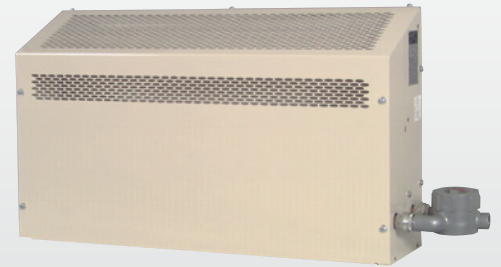

*Customizations not available for all products.

BWD SERIES

Washdown Corrosion-Resistant Unit Heater

HAZARDOUS
ENVIRONMENT
PRODUCTS
MARLEY CUSTOM CAPABILITIES



Crafted for **wet and corrosive environments**, this heater can withstand **direct spray down** with a hose all the way to the harsh environment of a **chemical plant**.

Key Features:

Brave the Elements

Comes with NEMA 4X junction box and epoxy coated enclosed ball bearing motor to protect against water and dust. Add in the additional epoxy coating for advanced corrosion resistance.

Designed with Comfort in Mind

316 Stainless Steel-finned elements for improved heat distribution so the heat reaches where you need it to be.

Fast and Easy Installation

14-gauge Stainless Steel wall/ceiling bracket provides multiple options for mounting and 24VAC controls improve safety with low voltage remote thermostat.

Built to Last

This heater is built out of 16 gauge 304 stainless steel and comes with an automatic high temperature reset limit to protect against overtemp situations.

Technical Specifications:

Temp Range: 55°-90°F

CFM: 700-2400

Ideal Spaces:

Wastewater Treatment Plants
Coal Handling Areas
Food Processing Plants
Greenhouses
Foundries
Steel Mills
Cement Plants
Car Washes
Ship/Marine Docks



Intertek

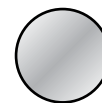

Stainless Steel



Scan the QR code to access additional specs and features.

BWD SERIES

Washdown Corrosion-Resistant Unit Heater

Models & Specifications:

		ELECTRICAL DATA						
CATALOG NO.	VOLTS	PHASE	WATTS	BTU/HR	MAX AMPS	BTU/HR	SHIP WT.	
● BWD02112	120	1	2	6824	16.7	700	60	
● BWD02812	208	1	2	6824	9.6	700	60	
● BWD02212	240	1	2	6824	8.3	700	60	
● BWD03112	120	1	3	10236	25	700	60	
● BWD03812	208	1	3	10236	14.4	700	60	
● BWD03212	240	1	3	10236	12.5	700	60	
● BWD03712	277	1	3	10236	10.8	700	60	
● BWD03832	208	3	3	10236	8.3	700	60	
● BWD03232	240	3	3	10236	7.2	700	60	
● BWD03432	480	3	3	10236	3.6	700	60	
● BWD05812	208	1	5	17060	24	700	60	
● BWD05212	240	1	5	17060	20.8	700	60	
● BWD05712	277	1	5	17060	18.1	700	60	
● BWD05412	480	1	5	17060	10.4	700	60	
● BWD05832	208	3	5	17060	13.9	700	60	
● BWD05232	240	3	5	17060	12	700	60	
● BWD05432	480	3	5	17060	6	700	60	
● BWD07812	208	1	7.5	25590	36.1	700	60	
● BWD07212	240	1	7.5	25590	31.3	700	60	
● BWD07712	277	1	7.5	25590	27.1	700	60	
● BWD07412	480	1	7.5	25590	15.6	700	60	
● BWD07832	208	3	7.5	25590	20.8	700	60	
● BWD07232	240	3	7.5	25590	18	700	60	
● BWD07432	480	3	7.5	25590	9	700	60	
● BWD10212	240	1	10	34120	41.7	1450	60	
● BWD10712	277	1	10	34120	36.1	1450	60	
● BWD10412	480	1	10	34120	20.8	1450	60	
● BWD10832	208	3	10	34120	27.8	1450	60	
● BWD10232	240	3	10	34120	24.1	1450	60	
● BWD10432	480	3	10	34120	12	1450	60	
● BWD12812	208	1	12.5	42650	60.1	1450	60	
● BWD12212	240	1	12.5	42650	52.1	1450	60	
● BWD12832	208	3	12.5	42650	34.7	1450	60	
● BWD12232	240	3	12.5	42650	30.1	1450	60	
● BWD12432	480	3	12.5	42650	15	1450	60	
● BWD15812	208	1	15	51180	72.1	2400	60	
● BWD15212	240	1	15	51180	62.5	2400	110	
● BWD15412	480	1	15	51180	31.3	2400	110	
● BWD15832	208	3	15	51180	41.6	2400	110	
● BWD15232	240	3	15	51180	36.1	2400	110	
● BWD15432	480	3	15	51180	18	2400	110	
● BWD20412	480	1	20	68240	41.7	2400	120	
● BWD20232	240	3	20	68240	48.1	2400	120	
● BWD20432	480	3	20	68240	24.1	2400	120	
● BWD25832	208	3	25	85300	69.4	2400	120	
● BWD25232	240	3	25	85300	60.1	2400	120	
● BWD25432	480	3	25	85300	30.1	2400	120	
● BWD30832	208	3	30	102360	83.3	2400	120	
● BWD30232	240	3	30	102360	72.2	2400	120	
● BWD30432	480	3	30	102360	36.1	2400	120	
● BWD39432	480	3	39	133068	46.9	2400	120	

SKU Legend: ● = Popular Products; ● = Extended Offering
 (Contact your local Marley Sales Representative for typically associated lead times)

HAZARDOUS ENVIRONMENT PRODUCTS

MARLEY CUSTOM CAPABILITIES

Optional Accessories (Factory-Installed Only):

Suffix	Description
T	Thermostat
L	Pilot Light
S	Selector Switch
D	Disconnect Switch
M	Manual Reset
P	Epoxy Coating

NOTE: Monel elements are subject to longer lead times. Please contact factory for details. All units other than standard models are non-returnable.

Dimensions and Clearances:

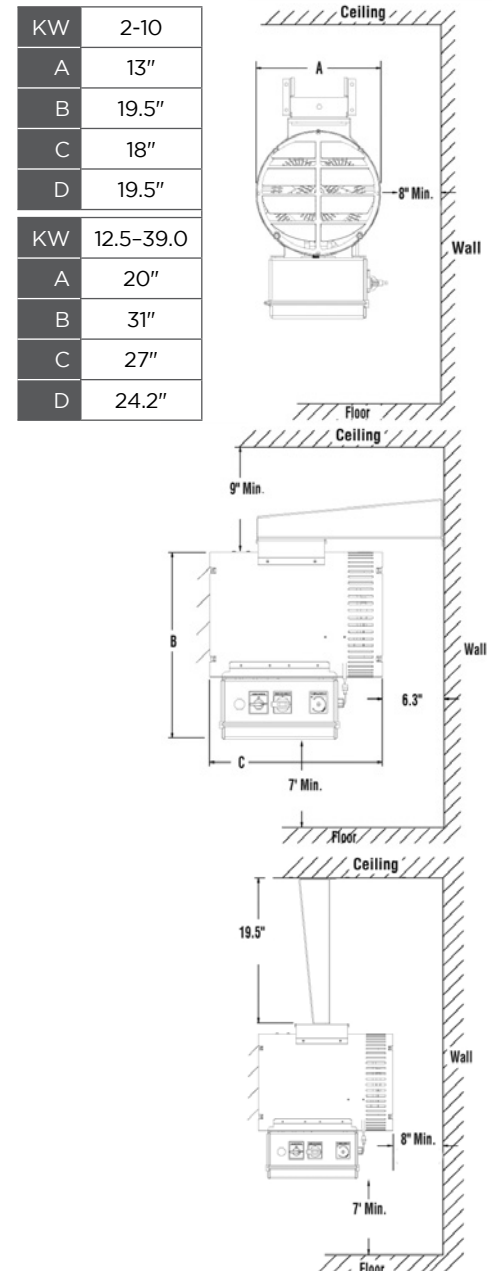

RUX SERIES

Explosion-Proof Unit Heater

HAZARDOUS
ENVIRONMENT
PRODUCTS
MARLEY CUSTOM CAPABILITIES

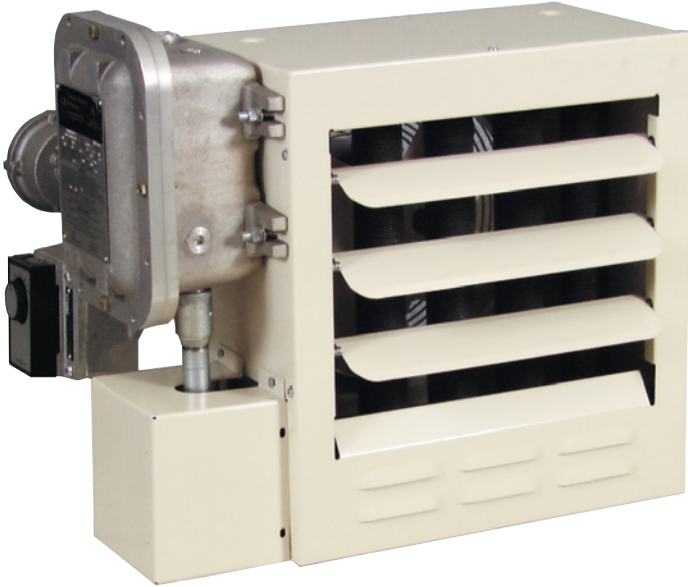

This heater was specifically designed to heat areas classified as hazardous locations and comes with a **thermally-protected motor** so you get heat fast and consistent while maintaining **top-of-the-line safety**.

Key Features:

Designed with Safety in Mind

Heater was designed to meet Class I, Groups C, and D, Division 1 and 2 or Class II, Groups E, F, and G, Division 1 and 2 and has a low operating temperature for atmospheres having an ignition temperature higher than 165°C (329°F)—code T3B

Innovative Design

Advanced heat exchanger design allows lower operating temperatures from liquid to air heat exchanger with steel tubes, aluminum fins, a non-toxic heat transfer fluid, and a pressure relief plug

Safety Comes Standard

Pre-wired, self-contained control center. Standard controls include automatic reset thermal limit, magnetic contactor, and 24V control circuit transformer with optional built-in thermostat, disconnect switch, pilot light, and manual reset

Built to Last

Powder-coated heavy-gauge steel cabinet surrounding 14-gauge heavy-duty steel frame supports internal components such as the permanently lubricated ball bearings and thermally protected explosion-proof motor

Technical Specifications:

Temp Range: 50–90°F

CFM: 700–2300

Ideal Spaces:

Oil Refineries & Oil Rigs
Sewage Treatment Plants
Petrochemical Plants
Unattended Pumping Stations
Chemical Storage Facilities
Chemical Handling Facilities
Paint Storage Areas
Other Hazardous Environments

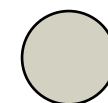

Navajo White



Scan the QR code to access additional specs and features.

RUX SERIES

Explosion-Proof Unit Heater

HAZARDOUS ENVIRONMENT PRODUCTS

MARLEY CUSTOM CAPABILITIES

Models & Specifications:

ITEM INFORMATION			ELECTRICAL DATA						SHIP WT.
CATALOG NO.	UPC	VOLTS	PHASE	WATTS	BTU/HR	MAX AMPS	CFM		
● RUX300812	685360068275	208	1	3	10,236	16.7	700	135 lbs	
● RUX300832	685360068343	208	3	3	10,236	9.7	700	135 lbs	
● RUX300412	685360068053	240	1	3	10,236	14.8	700	135 lbs	
● RUX300432	685360068091	240	3	3	10,236	8.6	700	135 lbs	
● RUX3004832	685360068152	480	3	3	10,236	4.3	700	135 lbs	
● RUX300632	685360068251	600	3	3	10,236	3.6	700	135 lbs	
● RUX500812	685360068602	208	1	5	17,060	26.3	700	135 lbs	
● RUX500832	685360068657	208	3	5	17,060	15.3	700	135 lbs	
● RUX500412	685360068381	240	1	5	17,060	23.1	700	135 lbs	
● RUX500432	685360068435	240	3	5	17,060	13.5	700	135 lbs	
● RUX5004832	685360068480	480	3	5	17,060	6.8	700	135 lbs	
● RUX500632	685360068589	600	3	5	17,060	5.6	700	135 lbs	
● RUX750812	685360068879	208	1	7.5	25,590	38.4	840	135 lbs	
● RUX750832	685360068893	208	3	7.5	25,590	22.2	840	135 lbs	
● RUX750412	685360068701	240	1	7.5	25,590	33.6	840	135 lbs	
● RUX750432	685360068749	240	3	7.5	25,590	19.4	840	135 lbs	
● RUX7504832	685360068787	480	3	7.5	25,590	9.7	840	135 lbs	
● RUX750632	685360068855	600	3	7.5	25,590	8.1	840	135 lbs	
● RUX1000832	685360067612	208	3	10	34,120	29.2	840	140 lbs	
● RUX1000412	685360067445	240	1	10	34,120	44.5	840	140 lbs	
● RUX1000432	685360067476	240	3	10	34,120	25.5	840	140 lbs	
● RUX10004832	685360067537	480	3	10	34,120	12.7	840	140 lbs	
● RUX1000632	685360067599	600	3	10	34,120	10.6	840	140 lbs	
● RUX1500832	685360067773	208	3	15	51,180	43	1450	160 lbs	
● RUX1500432	685360067650	240	3	15	51,180	37.5	1450	160 lbs	
● RUX15004832	685360067681	480	3	15	51,180	18.7	1450	160 lbs	
● RUX1500632	685360067759	600	3	15	51,180	15.7	1450	160 lbs	
● RUX20004832	685360067841	480	3	20	68,240	24.8	1400	171 lbs	
● RUX2000632	685360067919	600	3	20	68,240	20.7	1400	171 lbs	
● RUX25004832	685360067933	480	3	25	85,300	31.1	2330	216 lbs	
● RUX2500632	685360067964	600	3	25	85,300	25.8	2330	216 lbs	
● RUX30004832	685360067971	480	3	30	102,360	37.1	2330	216 lbs	
● RUX3000632	685360068015	600	3	30	102,360	30.2	2330	216 lbs	

SKU Legend: ● = Popular Products; ● = Extended Offering

(Contact your local Marley Sales Representative for typically associated lead times)

NOTE: Above models have built-in 24V control; optional 120V control is available (replace "2" suffix with "1" for 120V control). Includes element, motor, and transformer. All units with status "C" or "AS" are made-to-order and are non-returnable.

Dimensions and Clearances:

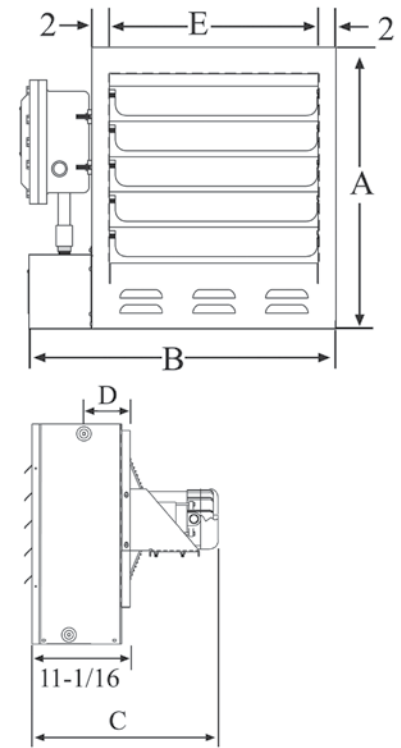

UNIT SIZE	3-10kW	15-20kW	25-30kW
A	19 1/8" 486 mm	25" 635 mm	32 1/8" 816 mm
B	23 7/8" 606 mm	27 7/8" 708 mm	31 7/8" 810 mm
C	21" 533 mm	21" 533 mm	21 3/4" 552 mm
D	3 1/8" 89 mm	4 13/32" 112 mm	5 1/2" 140 mm
E	13 5/8" 346 mm	17 5/8" 448 mm	21 5/8" 549 mm

Optional Accessories: Electrical**

SUFFIX	DESCRIPTION
AM	Automatic and Manual reset limits
T	Thermostat, 20°-80°F
L	Pilot Light (HEATER ON)
K	Pilot Light (LIMIT TRIPPED)
S	Selector Switch (AUTO/FAN ONLY)
D	Disconnect Switch — 15 amp for heaters rated 12 amps or lower Disconnect Switch — 30 amp for heaters between 13-24 amps Disconnect Switch — 60 amp for heaters 24 amps or higher
1*	120 Volt Control Transformer
E	Artic Construction

*Change heater suffix "2" to "1" for this option. ** Factory Installed only

Optional Accessories: Mechanical

CATALOG NO.	UPC	DESCRIPTION
RUXPM12	685360033792	Pole Mounting Bracket for units 3KW thru 10KW
RUXPM16	685360033808	Pole Mounting Bracket for units 15KW thru 20KW
RUXPM18	685360033815	Pole Mounting Bracket for units 25KW thru 30KW
RUXWM12	685360033822	Wall Mounting Kit for units 3KW thru 10KW
RUXWM16	685360033839	Wall Mounting Kit for units 15KW thru 20KW
RUXWM18	685360033846	Wall Mounting Kit for units 25KW thru 30KW
RUXCM0	685360033785	Ceiling/Hang Mounting Kit for all Models

NOTE: Specify type of mounting bracket required at time of order entry.

SCG SERIES

Explosion-Proof Convectors

HAZARDOUS
ENVIRONMENT
PRODUCTS
MARLEY CUSTOM CAPABILITIES



This heater was specifically designed to heat areas classified as hazardous locations and with **no moving parts** so you will have the peace of mind knowing this heater will keep your space warm while maintaining **top of the line safety**.

Key Features:

Designed with Safety in Mind

Heater was designed to meet Class I, Groups B, C, and D. Division 1 and 2 of Hazardous Environments and comes with a sloped top cabinet to prevent objects from restricting airflow.

Corrosion Resistant

Polyester powder-coating heavy-gauge steel provides excellent corrosion resistance.

High Grade Parts

High quality, long life tubular elements with high grade resistance wire embedded in MGO, centered in heavy gauge 1.25 in. diameter sheath with 3 x 3.25 in. fins and a sloped top.

Fast and Easy Installation

Explosion proof junction boxes and included wall mounting brackets make installation easy and quick.

Ideal Spaces:

- Oil Refineries & Oil Rigs
- Sewage Treatment Plants
- Petrochemical Plants
- Pumping Stations
- Chemical Storage Facilities
- Chemical Handling Facilities
- Paint Storage Areas
- Other Hazardous Areas

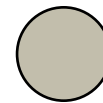

Beige



Scan the QR code to access additional specs and features.

SCG SERIES

Explosion-Proof Convectors

HAZARDOUS
ENVIRONMENT
PRODUCTS
MARLEY CUSTOM CAPABILITIES

Models & Specifications:

T2A Temperature Rating (536°F)							
ITEM INFORMATION		ELECTRICAL DATA					SHIP WT.
CATALOG NO.	UPC	VOLT	PHASE	WATT	BTU/HR	MAX AMPS	
●	SCG18001	685360069029	120	1	1.8	6,140	15
●	SCG18081	685360069227	208	1	1.8	6,140	8.7
●	SCG18083	685360069272	208	3	1.8	6,140	5
●	SCG18041	685360069067	240	1	1.8	6,140	7.5
●	SCG18043	685360069104	240	3	1.8	6,140	4.4
●	SCG18071	685360069203	277	1	1.8	6,140	6.5
●	SCG180481	685360069142	480	1	1.8	6,140	3.8
●	SCG180483	685360069173	480	3	1.8	6,140	2.2
●	SCG36081	685360069883	208	1	3.6	12,300	17.3
●	SCG36083	685360069913	208	3	3.6	12,300	10
●	SCG36041	685360069708	240	1	3.6	12,300	15
●	SCG36043	685360069739	240	3	3.6	12,300	8.7
●	SCG36071	685360069852	277	1	3.6	12,300	13
●	SCG360481	685360069777	480	1	3.6	12,300	7.5
●	SCG360483	685360069807	480	3	3.6	12,300	4.3
●	SCG36063	685360069845	600	3	3.6	12,300	6.3
●	SCG76081	685360085852	208	1	7.6	25,930	36.5
●	SCG76083	685360085869	208	3	7.6	25,930	21.1
●	SCG76041	685360085791	240	1	7.6	25,930	31.7
●	SCG76043	685360085807	240	3	7.6	25,930	18.3
●	SCG76071	685360085845	277	1	7.6	25,930	27.4
●	SCG760481	685360085814	480	1	7.6	25,930	15.8
●	SCG760483	685360085821	480	3	7.6	25,930	9.2
●	SCG76063	685360085838	600	3	7.6	25,930	9.2

Dimensions and Clearances:

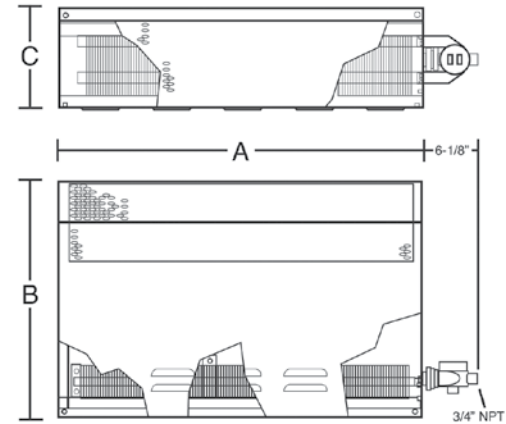

	KW	1.8 & 3.6	3.2 & 7.6
A Length		34"	58"
B Height		20"	20"
C Width		9"	9"

NOTE: Add 8 7/8" to total length of heater to allow for junction box on right side of heater.

T3A Temperature Rating (356°F)							
ITEM INFORMATION		ELECTRICAL DATA					SHIP WT.
CATALOG NO.	UPC	KW	VOLTS/PH.	AMPS	MOTOR	MAX AMPS	
●	SCG32081	685360069678	208	1	3.2	11,000	15.4
●	SCG32083	685360086545	208	3	3.2	11,000	8.9
●	SCG32041	685360069630	240	1	3.2	11,000	13.3
●	SCG32043	685360086538	240	3	3.2	11,000	7.7
●	SCG32071	685360069661	277	1	3.2	11,000	11.6
●	SCG320481	685360085753	480	1	3.2	11,000	6.7
●	SCG320483	685360085760	480	3	3.2	11,000	3.8
●	SCG32063	685360085777	600	3	3.2	11,000	5.6

SKU Legend: ● = Popular Products; ● = Extended Offering
(Contact your local Marley Sales Representative for typically associated lead times)

Optional Factory-Installed Accessories:

CATALOG NO.	DESCRIPTION
T	Thermostat 45°-85°F (Class I, Group C & D only)
CX	24V Control Contactor and Transformer (see note #2 below)
CX1	120V Control Contactor and Transformer (see note #3 below)
TB	Thermostat 45°-85°F (Class I, Group B,C, & D)

NOTE: Units with factory built-in controls will increase in length by 2-3/4 in. over what is shown above. 480V unit heaters with built-in thermostat require "CX" option. All units with status "C" or "AS" are made-to-order and are non-returnable.

A blanket of warmth for hard-to-heat areas

RADIANT HEATERS
MARLEY CUSTOM CAPABILITIES

Radiant technology works like the sun's rays to put warmth right where you need it — without having to heat (or pay for heating) the surrounding air.



Transit Station

Stadium

Loading Dock

Open-Air Dining

Barn

Offices & Basements

Why Radiant Heating

SAVE ON ENERGY & MAINTENANCE COSTS

By transferring warmth directly, radiant heaters don't waste energy heating the surrounding air. With no filters or moving parts to maintain, they are less costly to service as well.

HEAT WHERE AND WHEN YOU NEED IT

As a direct heat source, radiant output is unaffected by wind and rain. Berko radiant heaters can be used for everything from snow removal to cozying up counter and desk areas.

CLEANER ALTERNATIVE TO GAS HEATING

Berko radiant heaters can be installed in tight spaces with little to no clearance. There's no need for ducting or exhaust, so these heaters operate cleanly without circulating dust or fumes.

Versatile, Superior Value Both Indoors and Outdoors



Instant & Targeted Heat: Infrared energy delivers direct, uniform and localized heat — heating people and objects rather than the air, just like the sun.



Clean & Safe Heat: No fumes, odors or combustion. Does not circulate dust or other irritants and allergens.



Energy Efficient: Optimized shortwave infrared energy delivers continuous comfort efficiently without energy waste due to the wind and heating of the surrounding air.



Easy to Install: No need for gas lines, ducting or venting. Install in compact spaces.



Low Maintenance: No filters or moving parts to service.



Money Savings: Minimal upfront costs due to material and labor. Minimal energy usage and no need to purchase propane or other fuels to maintain operation.

*Customizations not available for all products.

CP SERIES

Radiant Ceiling Panels



Technical Specifications:

Dimensions: 2'x2' 2'x4' and Custom Sizing Available

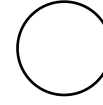

White



Custom Colors and
Silkscreens Available

Made-To-Order Models & Specifications:

ITEM INFORMATION			WATTS PER PANEL—NOMINAL PANEL LENGTH						
PANEL WIDTH	WATT DENSITY		24-35 (IN)	36-47 (IN)	48-59 (IN)	60-71 (IN)	72-83 (IN)	84-95 (IN)	96 (IN)
10-13"	High	■	155	235	315	390 [^]	-	-	-
	Med	■	130	195	260	325 [^]	-	-	-
	Low	■	105	155	210	260 [^]	-	-	-
14-17"	High	■	235	350	470	585 [^]	-	-	-
	Med	■	195	295	390	490 [^]	-	-	-
	Low	■	155	235	315	390 [^]	-	-	-
18-21"	High	■	315	470	625	780	940 ^{^^}	-	-
	Med	■	260	390	520	650	780 ^{^^}	-	-
	Low	■	210	315	415	520	625 ^{^^}	-	-
22-28"	High	■	375	565	750	940	1125	1315	1500
	Med	■	310	470	625	785	940	1095	1250
	Low	■	250	375	500	625	750	875	1000

SKU Legend: ■ = Made to Order (Contact your local Marley Sales Representative for typically associated lead times)

HOW TO ORDER

The catalog number for custom panels begins with the QT prefix followed:

- Watt Density (H, M, L)
- Panel Width
- Panel Length
- Voltage (1=120V; 8=208V; 2=240V; 7=277V; 3=347V)

For example, a 13 x 36 in. 240V unit with a high watt density would be QTH13362.

When ordering, please specify panel size as exact or nominal (panels can be up to 7/1 in. less in size).

[^] maximum panel length = 60 in.
^{^^} maximum panel length = 72 in.

Catalog No. for surface mounting frames (QSF) and recess mounting frames (QRF) begin with their respective prefix followed by width and length of panel.

Optional Mounting Accessories:

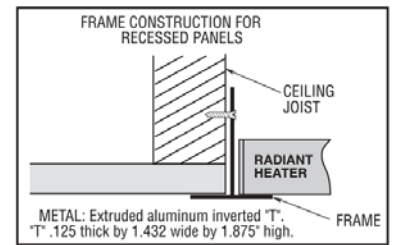
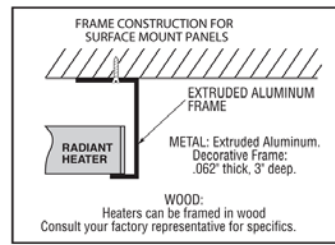
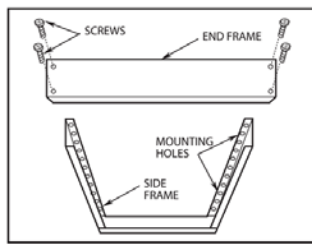
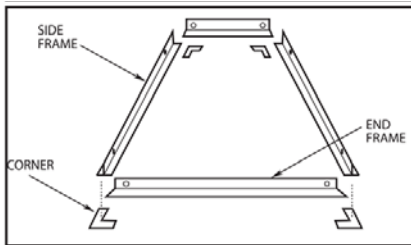

NOTE: Heating panels do not have a fire or hazardous rating, but construction is of fire retardant materials. Panels normally are treated like light fixtures. If necessary, acoustical tile can be placed on top of the panels.

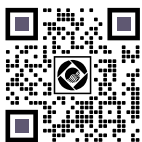
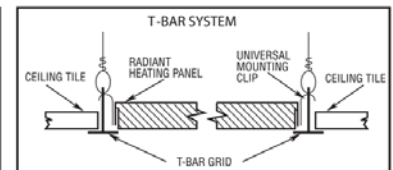
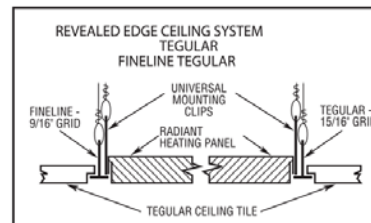

Scan the QR code to access
additional specs and features.

Additional Made-to-Order Features

Tegular (revealed edge)

Tegular systems may utilize a standard grid with a 1⁵/₁₆ in. cross-T or a “fine line” grid with a 9/₁₆ in. cross-T. The acoustical tile is notched to hang below the grid creating the revealed edge. Tegular panels are built with a support angle on all four sides to allow the panel front to drop flush with the finished ceiling. Tegular and Fine line Tegular panels are supplied standard with universal mounting clips installed for support chain.

Silkscreen

Radiant heating panels can be silk screened to provide an architectural blend with leading acoustical tiles. For T-bar, concealed spline and Tegular ceiling systems.

Custom Colors

Radiant heating panels can be painted any color desired with high temperature acrylic paints without affecting panel performance. Radiant energy is emitted from heating panels in the 8-10 micron wavelength range. One of the principal characteristics of the wavelength is that it is not color selective as are shorter wavelengths. Consequently, the surface color of the panel is unimportant to heating efficiency and can be considered solely in the light of aesthetics.

Panel Fronts for Continuous Ceiling Line

To provide a continuous ceiling line around the perimeter of a building, the factory can provide panel fronts to be interspersed between the functioning heating panels.

Controls

Power Relay—factory prewired to heaters. 30 amps single-pole with 24V, 120V, 208/240V or 277V holding coil voltages.

Longer Flexible Conduit

Panels will replace the standard 48 in. greenfield with up to 11 ft. of ½ in. flexible conduit.

Stainless Steel Construction

Special stainless steel panels are available for chlorine storage areas. Panels will be equipped with seal tight connectors and silicone sealed. If orders call for stainless steel construction the panels will be painted unless specified different. Three different finishes available; mill, mirror and brushed.

Factory Silicone-Sealed Panels

Exterior moisture and condensation do not affect heating panel performance, but water inside the unit can cause the panel to fail. Panels being used in locker rooms and swimming pool areas should be totally sealed with silicone at the factory before shipment, if there is a chance of moisture above the ceiling, then seal tight conduit and seal tight connectors also should be used.

Seal-Tight Flexible Conduit & Connectors

Radiant ceiling panels come with ½ in. greenfield flexible conduit and straight connectors. Seal-tight connectors and conduit can be substituted at the factor if panels are to be used in high moisture areas or if required by local electrical codes.

Heavier Duty Panels

For special installation the factory can use heavier gauge steel in the construction of the panels.

Modular Wiring Systems

For specific jobs, the factor can substitute modular connector for the straight connectors and pig tails that are standard equipment.

Optional Made-To-Order Accessories:

CUSTOM PANEL OPTIONS	DESCRIPTION
Silkscreen	To Provide An Architectural Blend With Leading Ceiling Tile, 2x5 ft. Max. There is a Panel Charge Each Time. If Manufacturer Does Not Have A Tile Pattern Screen There Is An Additional One-Time Charge. See Pricebook.
Custom Paint	Solid Color Custom Painted Panel - To Provide An Accent Strip
Tegular or Finline Tegular	Tegular - Reveal Edge Detail - (For 1 ⁵ / ₁₆ in. Grid) Construction Finline Tegular - Reveal Edge Detail - (For 9/ ₁₆ in. Grid)
Extra-length Greenfield Flex (½" x 48" Standard)	Custom Flexlength ½ x 60 in. / 72 / 84 / 96 / 108 / 120 in.
Sealtite Conduit	Custom Flexlength ½ x 60 in. / 72 / 84 / 96 / 108 / 120 in.
Silicone Seal	Seams Sealed For Added Moisture Protection. For Use In Shower Rooms And Above Pool Windows
Stainless Steel Construction	Stainless Steel - 22-Gauge Front Panel, 24-Gauge Back Panel. Includes ½ x 48 in. Sealtite Flex And Silicone Seal
Heavy Duty Construction	16-Gauge Galvanized Or Aluminized Steel Front Panel
	18-Gauge Galvanized Or Aluminized Steel Back Panel
Filler Panels	Finished To Match Standard, Silkscreen Or Custom Painted Panel. Does Not Contain An Element Or Flex Conduit. Standard Construction: Front Only. Tegular / Finline Tegular: Front And Back Only
Power Relay	24, 120, 208, 240, 277 VAC

NOTE: Custom products are made to order and non-returnable.

Infrared technology permits the heating of areas where it is impractical, either economically or physically, to heat air. The physics that causes warm air to rise and cool air to fall are constantly working against forced air heating systems, particularly in outdoor or high ceiling areas. The radiant heat energy emitted by infrared heaters is transferred direct to the people and objects under them. It is the same principle that allows the sun to make a clear, cold day feel warm. The radiant energy from infrared heaters can be directed and focused in any direction to evenly blanket people and equipment with comforting warmth, free from drafts and noisy fans or blowers.

Selecting the Right Models

Keep in mind these elements when selecting the correct infrared heater for your needs. **Consult your MEP sales representative for additional design assistance.**

- 1. Type of application:** area heating, snow melting, or spot heating
- 2. Type of environment:** outdoors, indoors, marine or corrosive atmospheres
- 3. Design area:** square footage, objects/people standing or sitting
- 4. Watt density required to maintain comfort**
- 5. Mounting height**

6. Selecting Proper Heat Pattern

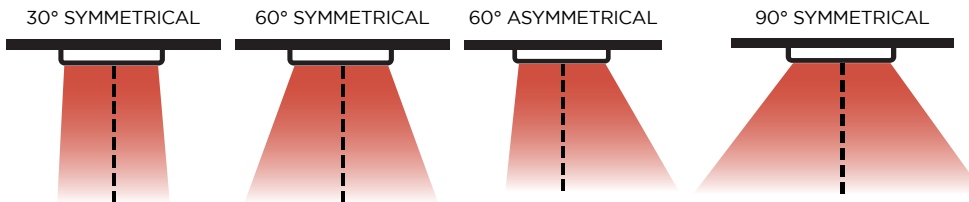

7. Selecting Proper Heating Elements

Metal Sheath
High Traffic Areas

- Impact ✓✓✓
- Vibration ✓✓✓
- Splashing ✓✓✓
- Wind ✓

Quartz Tube
Indoor/Outdoor Area/Spot Heating

- Impact ✓
- Vibration ✓
- Splashing ✓✓✓
- Wind ✓✓

Quartz Lamp
High Bays, Snow Melting

- Impact ✓
- Vibration ✓
- Splashing ✓✓
- Wind ✓✓✓

RESPONSE TIME, EFFICIENCY, INTENSITY/OUTPUT

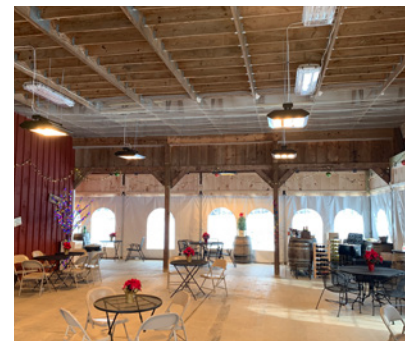

8. Product Selection After determining the requirements above, visit the product portion of our catalog to select appropriately sized heaters for your application. Contact your sales representative for more information on which infrared heaters will work for your specific application.

9. Control Optimization For the optimal preforming solution, it is important to understand how the application space should be controlled. Marley offers a variety of control solutions for various types of applications needs. Please consult your sales representative for more information on which control options are ideal for your specific application.



VRP/VRS SERIES

Commercial/Industrial Infrared Heater



Technical Specifications:

Element Types:

Metal Sheath, Quartz Tube, Quartz Lamp

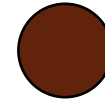

Bronze

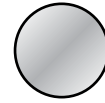

Stainless Steel

Enclosure: Dimensions*

	Height	Width	Length		
2 Bulb	7 1/8"	15"	24"	33"	46"
3 Bulb		12 1/2"			

NOTE: All models are NON-STOCK, MADE-TO-ORDER. When ordering, specify quantity, catalog number, voltage, wattage, optional controls, and finish. Consult sales representative for lead times.

Reflection Angle*

30° Sym.	60° Asym.
60° Sym.	90° Sym.

Maximum Wattage - 2-Element Enclosure:

	METAL SHEATH	QUARTZ TUBE	QUARTZ LAMP
24"	1,700	2,000	3,200
33"	3,000	3,000	5,000
46"	4,000	4,000	7,300

Element Wattage*

Metal Sheath	850	1500	2000
Quartz Tube	1000	1500	2000
Quartz Lamp	1600	2500	3650

*Specs vary by size. Refer to the submittal sheet for full details.

Element Voltages*

208	240	277
347	480	600

Maximum Wattage - 3-Element Enclosure:

	METAL SHEATH	QUARTZ TUBE	QUARTZ LAMP
24"	2,500	3,000	4,800
33"	4,500	4,500	7,500
46"	6,000	6,000	10,950

Optional Accessories:

CATALOG NO.	UPC	DESCRIPTION	COMPATIBLE WITH	CARTONS	SHIP WT.
FWG22	685360084060	Wire Guard for 2-Element Heaters	FRS2/FRP2 (24 in. L)	1	1 lbs
FWG23	685360084077	Wire Guard for 2-Element Heaters	FRS2/FRP2 (33 in. L)	1	1.5 lbs
FWG24	685360084084	Wire Guard for 2-Element Heaters	FRS2/FRP2 (46 in. L)	1	2 lbs
FWG32	685360084091	Wire Guard for 3-Element Heaters	FRS3/FRP3 (24 in. L)	1	1.5 lbs
FWG33	685360084107	Wire Guard for 3-Element Heaters	FRS3/FRP3 (33 in. L)	1	2 lbs
FWG34	685360084114	Wire Guard for 3-Element Heaters	FRS3/FRP3 (46 in. L)	1	2.5 lbs
FRPATMB	685360084022	Adjustable Tilt Mounting Bracket - FRP Series		1 Set	1 lbs
FRSATMB	685360084046	Adjustable Tilt Mounting Bracket - FRS Series		1 Set	1 lbs
FRPWMB	685360084039	Wall Mounting Bracket - FRP Series		1 Set	6 lbs
FRSWMB	685360084053	Wall Mounting Bracket - FRS Series		1 Set	6 lbs
RVS2	685360137650	24 in. Red Vycor sleeve	FR(*)22/FR(*)32	1	-
RVS3	685360137667	33 in. Red Vycor sleeve	FR(*)23/FR(*)33	1	-
RVS4	685360137674	46 in. Red Vycor sleeve	FR(*)24/FR(*)34	1	-

(1) One element per carton order. * Denotes remaining catalog number (See Enclosure Chart).

Metal Sheathed: used indoors or outdoors in high-traffic areas; Quartz Tube and Quartz Lamp: used indoors and outdoors for snow melting and spot heating. Bronze finish is not intended for direct salt spray exposure in marine applications or highly corrosive greenhouse, swimming pool, chemical storage or industrial atmospheres. Maintain at least 5 ft. in radiant path, between bottom of heater and combustible material. Pigtail element leads for a more positive connection in high-traffic areas where physical abuse.

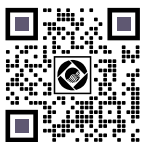

Scan the QR code to access additional specs and features.

MOUNTING CLEARANCES

- 24 in. to vertical side walls
- 36 in. between heaters mounted side by side. Heaters may be mounted end to end.
- 6 in. to ceiling
- 84 in. to floor

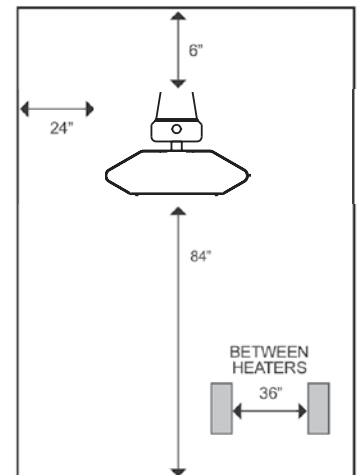



Key Features:

Multiple Configurations

Factory-wired for efficient installations and include terminal blocks, on/off selector switches, power ON pilot light, and a 24V or 120V control circuit. Control transformer with fused primary and secondary

Wide Range of Electrical Specifications

Panels are available for use in 208V, 240V, 277V, 480V and 600V systems, with amp loads up to 40, 50, 100, 200 and 300 amps (inductive load—see chart below for resistive load rating).

Durable Construction

NEMA 1 enclosure, UL/cUL listed and labeled control panel.

Models & Specifications:

ITEM INFORMATION				ELECTRICAL DATA			DIMENSIONAL DATA	
CATALOG NO.	UPC	DESCRIPTION	AMPS*	VOLTS	SUPPLY VOLTS	DIMENSIONS	SHIP WT.	
CP404801PT	685360138930	Percentage Timer Panel, (1) 3-Pole Contactor	40A	208-480V	120V	14.5" H x 14.5" W x 7.5" D	45 lbs	
CP404801CT	685360138923	Time Delay Controller, (1) 3-Pole Contactor	40A	208-480V	120V	14.5" H x 14.5" W x 7.5" D	45 lbs	
CP504801	685360139005	(1) 3-Pole Contactor Panel	40A	208-480V	120V	14.5" H x 14.5" W x 7.5" D	45 lbs	
CP1004801	685360138800	(2) 3-Pole Contactor Panel	100A	208-480V	120V	14" H x 15" W x 7.75" D	55 lbs	
CP2004801	685360138848	(4) 3-Pole Contactor Panel	200A	208-480V	120V	31.5" H x 18.2" W x 10" D	65 lbs	
CP3004801	685360138886	(6) 3-Pole Contactor Panel	300A	208-480V	120V	36" H x 30" W x 7" D	70 lbs	

SKU Legend: ■ = Made to Order (Contact your local Marley Sales Representative for typically associated lead times)

*Amp rating inductive load. Line fusing supplied by installer. Percentage Timer Panel for Metal Sheath Heaters only. Contact factory for 24V control, 600V supply, and Nema 4 enclosures. Add 25% to list price for stainless steel (NEMA 4x) rating.



Scan the QR code to access additional specs and features.

Create an invisible air barrier with air curtains from Berko.

Air curtains stop heat loss and pests in their tracks creating separate spaces within one environment.

Compatibility Chart

WIND CONDITIONS CLASSIFICATIONS*			
G=1-5 mph L=5-8 mph M=8-12 mph ST=12-15 mph			
DOOR HEIGHT	ENVIRONMENTAL SERIES		
	1/4 HP	1/2 HP	3/4 HP
8 FT. INTERIOR	G		
10 FT. INTERIOR		G	
8 FT. EXTERIOR	L	M	ST
10 FT. EXTERIOR		L	M
7 FT. CUSTOMER ENTRANCE	L		
8 FT. CUSTOMER ENTRANCE	L		
7 FT. SERVICE ENTRANCE		M	ST
8 FT. SERVICE ENTRANCE		L	M
7 FT. COOLER			
8 FT. COOLER	G		
10 FT. COOLER		G	
12 FT. COOLER			G
8 FT. FREEZER		G	
10 FT. FREEZER			G
12 FT. FREEZER			G
8 FT. EXTERIOR			M
10 FT. EXTERIOR			
12 FT. INTERIOR OPENING			
14 FT. INTERIOR OPENING			
10 FT. EXTERIOR DOORWAY			
12 FT. EXTERIOR DOORWAY			
14 FT. EXTERIOR DOORWAY			

*Wind conditions G = Gentle; L = Light; M = Moderate; ST = Strong;



WIND RESISTANCE CHART

DOOR HEIGHT (FT)

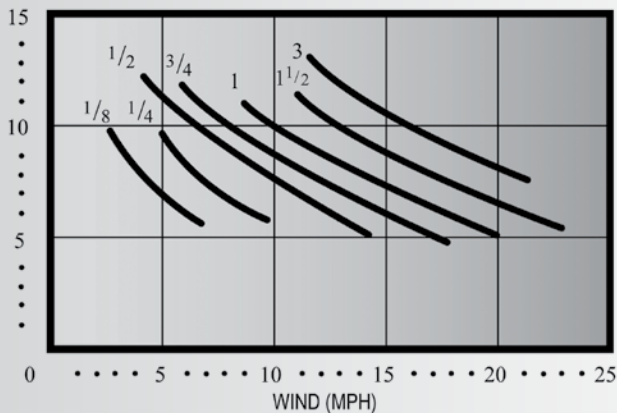

Air curtains are used for a wide variety of applications from thermal barriers at shopping mall entrances, to fly and insect prevention at restaurant service doors, to factory freight doors for wind resistance and temperature separation. The air curtain enables traffic to flow unobstructed through openings while maintaining separate environments, thus resulting in energy savings.

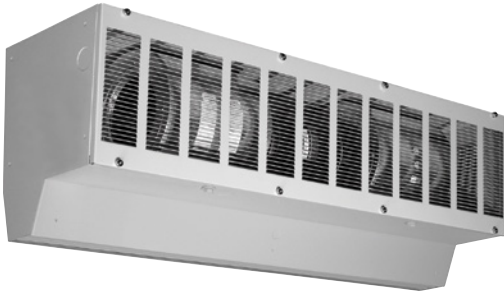

This air curtain acts as a thermal barrier or interior separation device for mounting heights of 8-10 ft.

 	 White	 Beige	 Bronze	Ideal Spaces: Supermarkets Schools Hospitals Restaurants Bakeries Cafeterias Freezers Processing Plants
	 Black	 Aluminum		

Models & Specifications:

ITEM INFORMATION			ELECTRICAL DATA						SHIP WT.
CATALOG NO.	WIDTH (IN)	MAX VELOCITY (FPM) HI/LOW*	AVG VELOCITY (FPM) HI/LOW*	AVG AIR FLOW RATE (CFM) HI/LOW*	MOTORS (QTY @ HP)	INPUT POWER RATING 1 PH (KW)**	INPUT POWER RATING 3 PH (KW)**		
1/4 HP Models	E36001#25	36	2800 / 1850	2000 / 1480	1620 / 1200	1 @ 1/4	0.41	0.24	65 lbs
	E38001#25	38	2800 / 1850	1955 / 1450	1670 / 1240	1 @ 1/4	0.41	0.24	67 lbs
	E42001#25	42	2800 / 1850	1900 / 1410	1795 / 1330	1 @ 1/4	0.41	0.24	70 lbs
	E48001#25	48	2800 / 1850	1855 / 1375	2000 / 1480	1 @ 1/4	0.41	0.24	77 lbs
	E60002#25	60	2800 / 1850	2125 / 1575	2880 / 2135	2 @ 1/4	0.82	0.48	128 lbs
	E72002#25	72	2800 / 1850	2000 / 1480	3240 / 2400	2 @ 1/4	0.82	0.48	130 lbs
	E76002#25	76	2800 / 1850	1955 / 1450	3340 / 2475	2 @ 1/4	0.82	0.48	134 lbs
	E84002#25	84	2800 / 1850	1915 / 1420	3620 / 2680	2 @ 1/4	0.82	0.48	142 lbs
	E96002#25	96	2800 / 1850	1855 / 1375	4000 / 2960	2 @ 1/4	0.82	0.48	154 lbs
	E10803#25	108	2800 / 1850	2000 / 1480	4860 / 3600	3 @ 1/4	1.23	0.72	195 lbs
	E12003#25	120	2800 / 1850	1945 / 1440	5240 / 3880	3 @ 1/4	1.23	0.72	207 lbs
	E13203#25	132	2800 / 1850	1895 / 1405	5620 / 4160	3 @ 1/4	1.23	0.72	219 lbs
E14403#25	144	2800 / 1850	1855 / 1375	6000 / 4440	3 @ 1/4	1.23	0.72	231 lbs	
1/2 HP Models	E36001#50	36	3800 / 2815	3040 / 2250	2460 / 1820	1 @ 1/2	0.62	0.40	74 lbs
	E38001#50	38	3800 / 2815	2965 / 2195	2535 / 1880	1 @ 1/2	0.62	0.40	76 lbs
	E42001#50	42	3800 / 2815	2890 / 2140	2730 / 2020	1 @ 1/2	0.62	0.40	79 lbs
	E48001#50	48	3800 / 2815	2815 / 2085	3040 / 2250	1 @ 1/2	0.62	0.40	86 lbs
	E60002#50	60	3800 / 2815	3230 / 2390	4375 / 3240	2 @ 1/2	1.25	0.80	148 lbs
	E72002#50	72	3800 / 2815	3040 / 2250	4920 / 3645	2 @ 1/2	1.25	0.80	148 lbs
	E76002#50	76	3800 / 2815	2965 / 2195	5070 / 3755	2 @ 1/2	1.25	0.80	152 lbs
	E84002#50	84	3800 / 2815	2910 / 2155	5500 / 4070	2 @ 1/2	1.25	0.80	160 lbs
	E96002#50	96	3800 / 2815	2815 / 2085	6080 / 4500	2 @ 1/2	1.25	0.80	172 lbs
	E10803#50	108	3800 / 2815	3040 / 2250	7380 / 5465	3 @ 1/2	1.87	1.20	222 lbs
	E12003#50	120	3800 / 2815	2950 / 2184	7960 / 5890	3 @ 1/2	1.87	1.20	234 lbs
	E13203#50	132	3800 / 2815	2875 / 2130	8540 / 6320	3 @ 1/2	1.87	1.20	246 lbs
E14403#50	144	3800 / 2815	2815 / 2085	9120 / 6750	3 @ 1/2	1.87	1.20	258 lbs	
3/4 HP Models	E36001#75	36	4850 / 3590	3880 / 2875	3140 / 2325	1 @ 3/4	0.94	1.20	83 lbs
	E38001#75	38	4850 / 3590	3790 / 2805	3240 / 2400	1 @ 3/4	0.94	1.20	86 lbs
	E42001#75	42	4850 / 3590	3685 / 2730	3480 / 2575	1 @ 3/4	0.94	1.20	89 lbs
	E48001#75	48	4850 / 3590	3595 / 2660	3880 / 2875	1 @ 3/4	0.94	1.20	96 lbs
	E60001#75	60	4850 / 3590	3395 / 2510	4580 / 3390	1 @ 3/4	1.87	2.39	112 lbs
	E72002#75	72	4850 / 3590	3880 / 2875	6280 / 4650	2 @ 3/4	1.87	2.39	166 lbs
	E76002#75	76	4850 / 3590	3790 / 2805	6480 / 4795	2 @ 3/4	1.87	2.39	172 lbs
	E84002#75	84	4850 / 3590	3715 / 2750	7020 / 5195	2 @ 3/4	1.87	2.39	179 lbs
	E96002#75	96	4850 / 3590	3595 / 2660	7760 / 5745	2 @ 3/4	1.87	2.39	192 lbs
	E10803#75	108	4850 / 3590	3880 / 2875	9420 / 6975	3 @ 3/4	2.81	3.59	249 lbs
	E12003#75	120	4850 / 3590	3765 / 2790	10160 / 7520	3 @ 3/4	2.81	3.59	262 lbs
	E13203#75	132	4850 / 3590	3670 / 2720	10900 / 8070	3 @ 3/4	2.81	3.59	275 lbs
E14403#75	144	4850 / 3590	3595 / 2660	11640 / 8615	3 @ 3/4	2.81	3.59	288 lbs	

SKU Legend: ■ = Made to Order (Contact your local Marley Sales Representative for typically associated lead times)

*Low speed only available on 1-Phase units. **AMP draw estimated as 1 PH = Power Rating x 1,000 / Volts and 3 PH = Power Rating x 1,000 / Volts x 1.732. # Indicate Voltage: 1 = 120/1, 2 = 220/1, 3 = 208/3, 4 = 230/3, 5 = 460/3.

Control your comfort with easy-to-use features and money-saving controls

THERMOSTATS & CONTROLS

Don't forget the thermostat! Go to page 109 to find a compatible model for your custom order.

M601W / M602W

Best Sellers | Easy Installation and Control | Great Low Cost Solution



MD26



CNTLTSTDNP1H1C

*Advanced Comfort Control
Sleek and Modern Design
Accurate Low Voltage Solution*



LTR2240

*Direct Low Voltage Control for High Amp Loads
Allows for BMS Integration
Microprocessor Base Design*



BERKO[®] HEATING SOLUTIONS

Quickly bring warmth to any area.



**EASY
INSTALLATION**



**CONTROL
OPTIONS**



**AFFORDABLE
PERFORMANCE**



**SAFE
OPERATION**