



Item#: **55352**
LED 4' WRAP-A-ROUND
 DIRECT LINEAR AMBIENT LUMINARIES

FEATURES

- Low-profile which meets limitless range of applications.
- Use 30% less energy than a traditional fluorescent fixture
- Standard knocks on back and ends.
- All steel surfaces are painted after fabrication with high gloss baked white matte powder paint.
- Low-glare prismatic lens

MOUNTING

Designed for surface and suspended mounting.

APPLICATION

Ideal for stairways, bathrooms and low light traffic areas.

PERFORMANCE DATA

ELECTRICAL

Wattage	38W
Voltage	120-277V
Current	0.31A
Power Factor	0.9
Total Harmonic Distortion (THD)	<20

LIGHTING PERFORMANCE

Lumens	4920
Lumens Per Watt (Lm/W)	130
Color Temperature (CCT)	4000K
Color Rendering (CRI)	80
R9 (Red Value)	--
R13 (Skin Tones)	--
Beam Angle	100°
Light Distribution	--
BUG Rating (Backlight, Uplight, and Glare)	--
Dimmable Lighting Control	<i>Dimmable</i> 0-10V, Range 10% - 100%

ENVIRONMENT

Operating Temperature	-4° ~ 122°F
Suitable Location	DAMP
Ingress Protection Rating	IP40

LIFESPAN

Average Life (Hours)	50,000
Warranty (Years)	5

COMPONENTS

LED Light Source	Seoul
Driver	--

CONSTRUCTION

Housing	24 Gauge Steel
Base / Power Supply	Hard Wired
Finish	White

QUALIFICATIONS



Published lumens on LED products are approximate and may vary slightly. • Specifications are subject to change without notice.

Item#: **55352**
LED 4' WRAP-A-ROUND



DIMENSIONS (Inches)

Length	48.6"
Width	6.5"
Height	2.5"
Net Weight (Lbs)	--

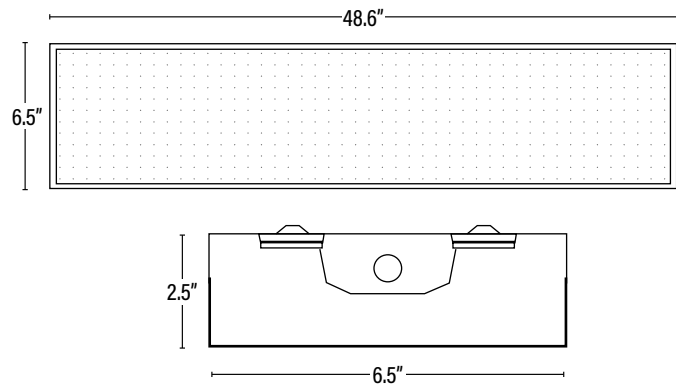

SUPPORTING DOCUMENTS (Grey = not available at this time.)

Product Sheet	VIEW
Install Instructions	VIEW
IES Download from Web Item	VIEW
LM79	VIEW
LM80	VIEW

PACKAGING

		UPC	DIMENSIONS (LxWxH)	GROSS WEIGHT (Lbs)
Master Carton	4	10811768028727	--	--
Individual Box	1	811768028720	--	--
Country of Origin	China			
HS Tariff	9405.10.6020			

ORDERING

ITEM#	DESCRIPTION	CASE
55352	LED 4' WRAP A-ROUND - 38W/40K/FR/120-277V/DIMMABLE/V2 - SUPERIOR LIFE®	1

ACCESSORIES

54896	360° LOW/HIGH BAY FIXTURE OCCUPANCY PIR SENSOR 30' DIA, 8-40' HEIGHT 800W/1200W • 120/277V - SUPERIOR LIFE®	50
54897	360° LOW BAY BI-LEVEL AND DAYLIGHT HARVEST MICROWAVE SENSOR 48' DIA, 8-20' HEIGHT 800W/1200W • 120/277V - SL®	50
54898	360° HIGH BAY BI-LEVEL AND DAYLIGHT HARVEST MICROWAVE SENSOR 60' DIA, 8-50' HEIGHT 800W/1200W • 120/277V - SL®	50
54894	EXTENDER MOUNT FOR SENSOR 54896/54897/54898 - SUPERIOR LIFE®	100
55390	EMERGENCY PACK FOR LED FIXTURE 8W/90 MIN/SPLIT TYPE/L - SL® T20C (For use with drivers that are 100W or less.)	10
55391	EMERGENCY PACK FOR LED FIXTURE 16W/90 MIN/SPLIT TYPE/L - SL® T20C (For use with drivers that are 100W or less.)	10
55392	EMERGENCY PACK FOR LED FIXTURE 25W/90 MIN/SPLIT TYPE/L - SL® T20C (For use with drivers that are 100W or less.)	10

REPLACEMENT PARTS

--	REPLACEMENT DRIVER	1
----	--------------------	---

ADDITIONAL INFORMATION:

Family Item(s): 55353/5000K