

INSTALLATION INSTRUCTIONS

READ IMPORTANT SAFETY TIPS BEFORE PROCEEDING WITH INSTALLATION

SAFETY TIPS

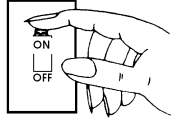

Turn fixture off! (Place wall switch in off position, if fixture has built-in switch or chain pull, switch or pull chain so fixture is off.)



Next - go to the main fuse box. If your fuse box has an ON/OFF switch, simply place main power switch in OFF position.

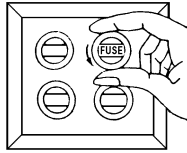

Screw-in type fuses - unscrew the fuse or fuses that control the power to the fixture or room you are working in.

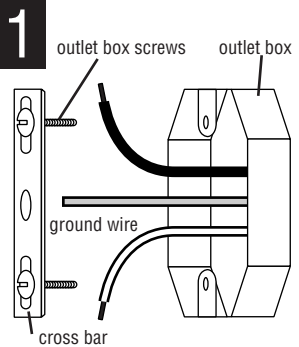

ATTACH cross bar to outlet box with outlet box screws (8-32 x 1/2, 2 slotted screws provided).

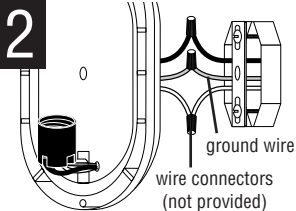

CONNECT THE WIRES. NOTE: Attach black fixture wire to black supply wire, white fixture wire to white supply wire. Do not mix them up. Use wire connectors (not provided). Connect bare fixture ground wire to ground wire from outlet box. NEVER CONNECT GROUND WIRE TO BLACK OR WHITE POWER SUPPLY WIRES.

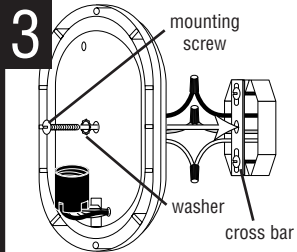

POSITION THE FIXTURE over the outlet box and secure in place with the mounting screw (1/4-20 x 1,1 provided). Screw lamp into lampholder. Use lamp type and wattage specified on fixture

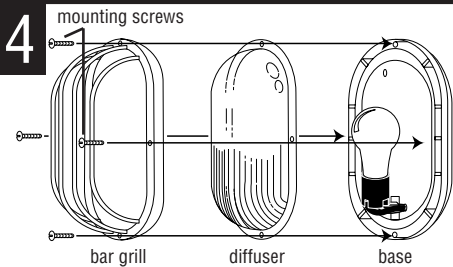

Place diffuser on fixture base. Then place bar grill or frame (depending on fixture model) over diffuser and attach to base with mounting screws (8-32x1/2, 4 combination head screw provided). NOTE: On models with hood, attach diffuser to base with one combination head mounting screw at center top of base only. Place hood over diffuser and secure to base with remaining three mounting screws. NOTE: Outdoor wall fixture MUST be caulked with an acrylic caulk where base of fixture meets mounting surface. This provides a water tight seal when fixture is installed.

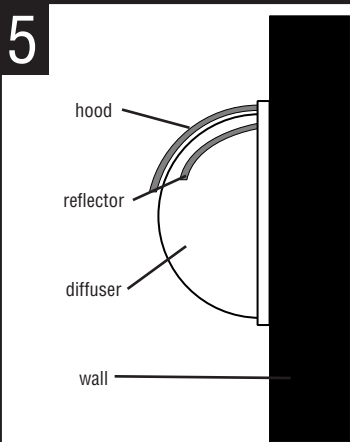

ON MODELS WITH HOOD, attach to wall with reflector up. Hood is to be placed above reflector as shown.



Clean only with mild soap and water. Avoid spraying with cleansers, insecticides, and pesticides that are petroleum based hydrocarbon products. These will degrade Luminaire.

INSTALLATION INSTRUCTIONS

READ IMPORTANT SAFETY TIPS BEFORE PROCEEDING WITH INSTALLATION

SAFETY TIPS

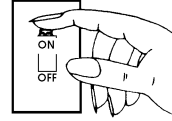

Turn fixture off! (Place wall switch in off position, if fixture has built-in switch or chain pull, switch or pull chain so fixture is off.)



Next - go to the main fuse box. If your fuse box has an ON/OFF switch, simply place main power switch in OFF position.

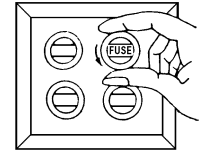

Screw-in type fuses - unscrew the fuse or fuses that control the power to the fixture or room you are working in.

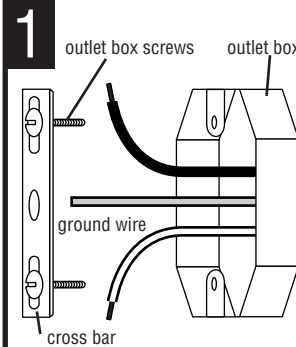

ATTACH cross bar to outlet box with outlet box screws (8-32 x 1/2, 2 slotted screws provided).

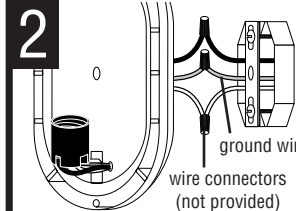

CONNECT THE WIRES. NOTE: Attach black fixture wire to black supply wire, white fixture wire to white supply wire. Do not mix them up. Use wire connectors (not provided). Connect bare fixture ground wire to ground wire from outlet box. NEVER CONNECT GROUND WIRE TO BLACK OR WHITE POWER SUPPLY WIRES.

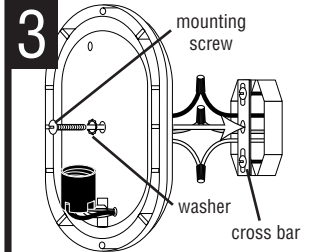

POSITION THE FIXTURE over the outlet box and secure in place with the mounting screw (1/4-20 x 1,1 provided). Screw lamp into lampholder. Use lamp type and wattage specified on fixture

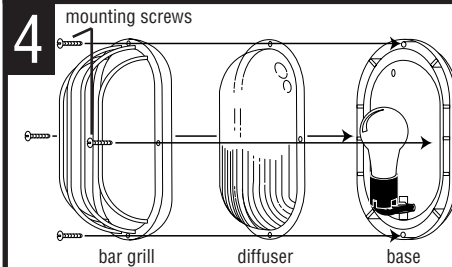

Place diffuser on fixture base. Then place bar grill or frame (depending on fixture model) over diffuser and attach to base with mounting screws (8-32x1/2, 4 combination head screw provided). NOTE: On models with hood, attach diffuser to base with one combination head mounting screw at center top of base only. Place hood over diffuser and secure to base with remaining three mounting screws. NOTE: Outdoor wall fixture MUST be caulked with an acrylic caulk where base of fixture meets mounting surface. This provides a water tight seal when fixture is installed.

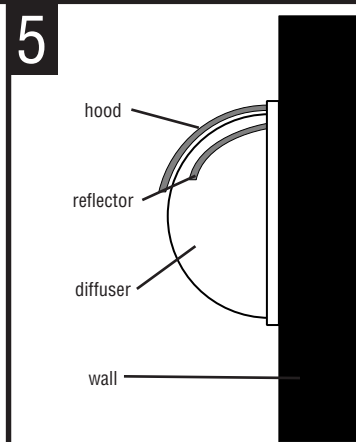

ON MODELS WITH HOOD, attach to wall with reflector up. Hood is to be placed above reflector as shown.



Clean only with mild soap and water. Avoid spraying with cleansers, insecticides, and pesticides that are petroleum based hydrocarbon products. These will degrade Luminaire.