

PROJECT NAME: \_\_\_\_\_  
NOTES: \_\_\_\_\_

CAT. #: \_\_\_\_\_  
FIXTURE SCHEDULE: \_\_\_\_\_

## M Series



BLACK & WHITE FINISH OPTIONS



200 - 300W FLEXIBLE ARM



100 - 150W STRAIGHT ARM



100 - 150W KNUCKLE SLIPFITTER



CHANGEABLE/ROTATABLE LENSES



100 - 150W TRUNNION



22 - 75W FIXED WALL



22 - 75W VARIABLE (ADJUSTABLE) WALL



TOOL-LESS DRIVER COMPARTMENT

### Product Description

The M Series provides a full Outdoor Lighting portfolio in one versatile product family. A singular housing thrives as either an Area, Flood or Wall fixture depending on the optics and mounting selected. Besides being CCT and Wattage selectable, it also offers changeable lenses enabling the customer to choose from 7 different distribution patterns. The optics offer improved back light and perimeter control as well as uniformity. These lenses are also rotatable allowing for customized orientation for your lighting application. It also includes a c-Max control port opening up the entire c-Max portfolio from Basic to more sophisticated Network controls systems. Tool less entry into the driver compartment makes maintenance easy. All of this comes with superior surge protection and a 10 year warranty. M Series offers design continuity and performance at a budget price point.

### Features

- Full Outdoor portfolio offering design continuity with Area, Flood and Wall applications
- Extensive wattage/lumen range - 15W to 300 Watts and 1,800- 40,000+ lumens
- Wattage Selectable & CCT Selectable between 3000/4000/5000K
- Superior photometrics with better backlight control and uniformity
- 7 changeable lenses fully rotatable at 90 degrees
- 6 different mounting options for wall, pole, ground or slipfitter applications
- Tool less driver compartment access
- Integrated networked lighting control, c-Max Bluetooth Lighting Control
  - Integral sensor receptacle
  - Occupancy sensor
  - Photocell
  - High-end trim
  - Energy monitoring
- 120-277V standard with 277-480V factory installed option
- Robust surge protection - 6kV + 10kA standard, 20kA option
- ANSI 3G vibration rated
- TAA available - contact Maxlite

### Installation

- 6 field changeable mountings available -Straight Arm, Flexible Arm, Knuckle Slipfitter, Trunnion, Variable (adjustable) Wall and Fixed Wall
- Mounting arms fit both square and round poles

### Construction

- Die cast aluminum housing with corrosion resistant polyester powder coat finish
- UV stabilized polycarbonate lens

### Application

- Area - 6 optics: Type 3 Medium, Type 4 Narrow, Type 4 Wide, Type 5 Square, Types 3 & 5 Low Glare
- Flood - 3 optics: Narrow 4x4, Concentrated Wide 6x6, and Soft Wide 6x7
- Wall - 4 optics: Type 3 Medium and Low Glare, Type 4 Narrow and Wide

# M Series

## Ordering Structure

FAMILY	WATTAGE	VOLTAGE	DISTRIBUTION	-	W SELECT	CCT	COLOR	MOUNTING*
M= M Series	<b>22=</b> 22W* <b>30=</b> 30/22/15W <b>42=</b> 42W* <b>55=</b> 55/42/30W <b>75=</b> 75/55/42W <b>100=</b> 100/75/55W <b>125=</b> 125W* <b>150=</b> 150/125/100W <b>200=</b> 200W* <b>300=</b> 300/250/200W <i>*Dedicated Wattage</i>	<b>U=</b> 120-277V <b>H=</b> 277-480V* <i>*Available 75W+</i>  <i>(Lower wattages available via wattage switch and c-Max node)</i>	<b>CN=</b> Narrow Flood <b>C3G=</b> Type 3 Low Glare <b>C3M=</b> Type 3 Medium <b>C4N=</b> Type 4 Narrow <b>C4W=</b> Type 4 Wide <b>CW=</b> Type 5 Low Glare/ Flood Wide 6x6 <b>C5S=</b> Type 5 Square/ Flood Wide 6x7  <i>See Accessories for lens part numbers if field changing the lens.</i>	-	<b>BLANK=</b> Dedicated wattage <b>W=</b> Wattage Selectable	<b>CS=</b> 3/4/5K Selectable	<b>B=</b> Dark Bronze <b>L=</b> Black <b>W=</b> white  <i>Contact MaxLite for additional finishes.</i>	<b>2=</b> Both Flexible Arm and Slipfitter <b>A=</b> Straight Arm <b>F=</b> Flexible Arm <b>K=</b> Knuckle Slipfitter <b>T=</b> Trunnion <b>V=</b> Variable (adjustable) Wall Mount <b>W=</b> Fixed Wall Mount <b>X=</b> Upper half knuckle, 4' SO cord**  <i>*X mounting is standard, all others are factory installed. Arms fit both square and round poles.                      **Order lower half mounting separately. (see Accessory Chart)</i>

CONTROLS	NEMA	EMERGENCY	SURGE PROTECTION
<b>CR=</b> C-Max Compatible (Standard)	<b>BLANK=</b> No NEMA Receptacle <b>FACTORY INSTALLED</b> <b>RPC**=</b> 3-Pin Twist Lock Receptacle <b>PR7**=</b> 7-Pin Twist Lock Receptacle  <i>**For &lt;75W, cannot have both RPC/PR7 and external SPD.</i>	<b>BLANK=</b> No EM <b>E2=</b> Battery Backup, -20°C, Fixed (Wall Mount Only, Factory Installed)  <i>"E2" option is only available for 22-55W, 120-277V UNV models.</i>	<b>BLANK=</b> 10kA + Driver kV (Standard for 75W+) <b>S=</b> 20kA + Driver kV  <i>(See Specification table for driver kV)</i>



c-Max Installation Video:  
[https://youtu.be/NyXBvYJZD\\_w](https://youtu.be/NyXBvYJZD_w)

## DLC Chart

### Primary Use Designation: Architectural Flood and Spot Luminaires

#### LOW OUTPUT: 22-30W

MODEL #	DLC PRODUCT ID
M22UCW-CS[ALL OPTIONS]	S-WC77W6
M22UCN-CS[ALL OPTIONS]	S-PB98N2
M22UC5S-CS[ALL OPTIONS]	S-6VWBY7
M30UC5S-WCS[ALL OPTIONS]	S-XTLBT8
M30UCW-WCS[ALL OPTIONS]	S-YTVK49

#### MID OUTPUT: 30-55W

MODEL #	DLC PRODUCT ID
M30UCN-WCS[ALL OPTIONS]	S-Z2BV3B
M42UCW-CS[ALL OPTIONS]	S-1SCB43
M42UCN-CS[ALL OPTIONS]	S-Z3QGT3
M42UC5S-CS[ALL OPTIONS]	S-99P1S0
M55UC5S-WCS[ALL OPTIONS]	S-W3YSW8
M55UCN-WCS[ALL OPTIONS]	S-JRN70M
M55UCW-WCS[ALL OPTIONS]	S-PNYFJC

#### HIGH OUTPUT: 75-150W

MODEL #	DLC PRODUCT ID
M75[U,H]C5S-WCS[ALL OPTIONS]	S-2Z7JTW
M75[U,H]CN-WCS[ALL OPTIONS]	S-KRTJSK
M75[U,H]CW-WCS[ALL OPTIONS]	S-CGSPZ0
M100[U,H]C5S-WCS[ALL OPTIONS]	S-KWY417
M100[U,H]CN-WCS[ALL OPTIONS]	S-6G006Q
M100[U,H]CW-WCS[ALL OPTIONS]	S-XGT0BQ
M125[U,H]C5S-CS[ALL OPTIONS]	S-8L8K46
M125[U,H]CN-CS[ALL OPTIONS]	S-ZNVR1H
M125[U,H]CW-CS[ALL OPTIONS]	S-YV4Q6V
M150[U,H]C5S-WCS[ALL OPTIONS]	S-KZ60WH
M150[U,H]CN-WCS[ALL OPTIONS]	S-F2P9NN
M150[U,H]CW-WCS[ALL OPTIONS]	S-PNFVCX

#### VERY HIGH OUTPUT: 200-300W

MODEL #	DLC PRODUCT ID
M200[U,H]C5S-CS[ALL OPTIONS]	S-J4HP9L
M200[U,H]CN-CS[ALL OPTIONS]	S-255TXZ
M200[U,H]CW-CS[ALL OPTIONS]	S-L2KZ8Y
M300[U,H]C5S-WCS[ALL OPTIONS]	S-YYFR5Z
M300[U,H]CN-WCS[ALL OPTIONS]	S-QHDY8W
M300[U,H]CW-WCS[ALL OPTIONS]	S-YH4GM9

## M Series

### DLC Chart

#### Primary Use Designation: Outdoor Full-Cutoff Wall-Mounted Area Luminaires

##### LOW OUTPUT: 22-30W

MODEL #	DLC PRODUCT ID
M22UCW-CS[ALL OPTIONS]	S-QNJH8V
M22UCN-CS[ALL OPTIONS]	S-QRF3PL
M22UC5S-CS[ALL OPTIONS]	S-V79GWK
M22UC4W-CS[ALL OPTIONS]	S-35KFQC
M22UC4N-CS[ALL OPTIONS]	S-NPDXL6
M22UC3M-CS[ALL OPTIONS]	S-XJLNJD
M22UC3G-CS[ALL OPTIONS]	S-Q99846
M30UC3G-WCS[ALL OPTIONS]	S-38K8D5
M30UC3M-WCS[ALL OPTIONS]	S-SJ3P9L
M30UC4N-WCS[ALL OPTIONS]	S-FLDH28
M30UC4W-WCS[ALL OPTIONS]	S-95F8KH
M30UC5S-WCS[ALL OPTIONS]	S-5MXFXW
M30UCW-WCS[ALL OPTIONS]	S-8VDQ77

##### MID OUTPUT: 30-55W

MODEL #	DLC PRODUCT ID
M30UCN-WCS[ALL OPTIONS]	S-X659NR
M42UCW-CS[ALL OPTIONS]	S-OPYWBF
M42UCN-CS[ALL OPTIONS]	S-SBQ2GP
M42UC5S-CS[ALL OPTIONS]	S-2QB8LR
M42UC4W-CS[ALL OPTIONS]	S-06HPKB
M42UC4N-CS[ALL OPTIONS]	S-55RBDM
M42UC3M-CS[ALL OPTIONS]	S-H4NNZ7
M42UC3G-CS[ALL OPTIONS]	S-RDCB6V
M55UC3G-WCS[ALL OPTIONS]	S-MR8KDC
M55UC3M-WCS[ALL OPTIONS]	S-G896C9
M55UC4N-WCS[ALL OPTIONS]	S-YHB9L5
M55UC4W-WCS[ALL OPTIONS]	S-RZN2QM
M55UC5S-WCS[ALL OPTIONS]	S-2NC2HV
M55UCN-WCS[ALL OPTIONS]	S-RCCD2T
M55UCW-WCS[ALL OPTIONS]	S-Q1S854

##### HIGH OUTPUT: 75W

MODEL #	DLC PRODUCT ID
M75[U,H]C3G-WCS[ALL OPTIONS]	S-F1P7MX
M75[U,H]C3M-WCS[ALL OPTIONS]	S-PXGKRT
M75[U,H]C4N-WCS[ALL OPTIONS]	S-TZW3VX
M75[U,H]C5S-WCS[ALL OPTIONS]	S-P7NP43
M75[U,H]CN-WCS[ALL OPTIONS]	S-LZVGPQ
M75[U,H]CW-WCS[ALL OPTIONS]	S-V06SSS

##### HIGH OUTPUT: 100-200W

MODEL #	DLC PRODUCT ID
M100[U,H]C3G-WCS[ALL OPTIONS]	S-FQPZ3J
M100[U,H]C3M-WCS[ALL OPTIONS]	S-ZPSCC5
M100[U,H]C4N-WCS[ALL OPTIONS]	S-N3LRND
M100[U,H]C4W-WCS[ALL OPTIONS]	S-959L64
M100[U,H]C5S-WCS[ALL OPTIONS]	S-7HF2QS
M100[U,H]CN-WCS[ALL OPTIONS]	S-BYL5GB
M100[U,H]CW-WCS[ALL OPTIONS]	S-3YT72X
M125[U,H]C3G-CS[ALL OPTIONS]	S-QGSKNQ
M125[U,H]C3M-CS[ALL OPTIONS]	S-Q8NC7M
M125[U,H]C4N-CS[ALL OPTIONS]	S-NMDF37
M125[U,H]C4W-CS[ALL OPTIONS]	S-Z66L8L
M125[U,H]C5S-CS[ALL OPTIONS]	S-0G33Z2
M125[U,H]CN-CS[ALL OPTIONS]	S-TM3325
M125[U,H]CW-CS[ALL OPTIONS]	S-K61BN6
M150[U,H]C3G-WCS[ALL OPTIONS]	S-BQVHFP
M150[U,H]C3M-WCS[ALL OPTIONS]	S-LQ9ZL4
M150[U,H]C4N-WCS[ALL OPTIONS]	S-2DRZR5
M150[U,H]C4W-WCS[ALL OPTIONS]	S-WJMY9L
M150[U,H]C5S-WCS[ALL OPTIONS]	S-MRMGXF
M150[U,H]CN-WCS[ALL OPTIONS]	S-G2MMZY
M150[U,H]CW-WCS[ALL OPTIONS]	S-T4QZQY
M200[U,H]C4N-CS[ALL OPTIONS]	S-Y8J55H
M200[U,H]C4W-CS[ALL OPTIONS]	S-6H5N4G

##### VERY HIGH OUTPUT: 200W

MODEL #	DLC PRODUCT ID
M200[U,H]C3G-CS[ALL OPTIONS]	S-GXPX78
M200[U,H]C3M-CS[ALL OPTIONS]	S-W50JDX
M200[U,H]C5S-CS[ALL OPTIONS]	S-DTZCQJ
M200[U,H]CN-CS[ALL OPTIONS]	S-B3NQVF
M200[U,H]CW-CS[ALL OPTIONS]	S-SHW4X3

##### VERY HIGH OUTPUT: 300W

MODEL #	DLC PRODUCT ID
M300[U,H]C3G-WCS[ALL OPTIONS]	S-T31GGK
M300[U,H]C3M-WCS[ALL OPTIONS]	S-2K8L0R
M300[U,H]C4N-WCS[ALL OPTIONS]	S-07ZJXP
M300[U,H]C4W-WCS[ALL OPTIONS]	S-LGC6GJ
M300[U,H]C5S-WCS[ALL OPTIONS]	S-VHKLTH
M300[U,H]CN-WCS[ALL OPTIONS]	S-DHJ46W
M300[U,H]CW-WCS[ALL OPTIONS]	S-SYNQ7Q

## M Series

### DLC Chart

Primary Use Designation: Outdoor Pole/Arm-Mounted Area and Roadway Luminaires

#### LOW OUTPUT: 22-30W

MODEL #	DLC PRODUCT ID
M22UC3G-CS[ALL OPTIONS]	S-0H4P2N
M22UC3M-CS[ALL OPTIONS]	S-XBZDFJ
M22UC4N-CS[ALL OPTIONS]	S-2ZB0HK
M22UC4W-CS[ALL OPTIONS]	S-YX2F1C
M22UC5S-CS[ALL OPTIONS]	S-XM7F6R
M22UCN-CS[ALL OPTIONS]	S-GHY2C2
M22UCW-CS[ALL OPTIONS]	S-RKRXY7
M30UC3G-WCS[ALL OPTIONS]	S-GC431R
M30UC3M-WCS[ALL OPTIONS]	S-Z9HS3J
M30UC4N-WCS[ALL OPTIONS]	S-VRJ1XQ
M30UC4W-WCS[ALL OPTIONS]	S-MG6DGQ
M30UC5S-WCS[ALL OPTIONS]	S-HCC38H
M30UCW-WCS[ALL OPTIONS]	S-WGGDD3

#### MID OUTPUT: 30-75W

MODEL #	DLC PRODUCT ID
M30UCN-WCS[ALL OPTIONS]	S-CFQJ85
M42UC3G-CS[ALL OPTIONS]	S-H1LPLD
M42UC3M-CS[ALL OPTIONS]	S-XGK8X4
M42UC4N-CS[ALL OPTIONS]	S-WNXRKC
M42UC4W-CS[ALL OPTIONS]	S-GQVYPB
M42UC5S-CS[ALL OPTIONS]	S-CGH254
M42UCN-CS[ALL OPTIONS]	S-VRG0SP
M42UCW-CS[ALL OPTIONS]	S-Z32C98
M55UC3G-WCS[ALL OPTIONS]	S-F9L9GW
M55UC3M-WCS[ALL OPTIONS]	S-FX4MCW
M55UC4N-WCS[ALL OPTIONS]	S-9Y21M7
M55UC4W-WCS[ALL OPTIONS]	S-KBQNQT
M55UC5S-WCS[ALL OPTIONS]	S-KDJSKB
M55UCN-WCS[ALL OPTIONS]	S-YJ5YGD
M75[U,H]C4W-WCS[ALL OPTIONS]	S-DYMLHB

#### HIGH OUTPUT: 75W

MODEL #	DLC PRODUCT ID
M75[U,H]C3G-WCS[ALL OPTIONS]	S-KPLLJB
M75[U,H]C3M-WCS[ALL OPTIONS]	S-27KF49
M75[U,H]C4N-WCS[ALL OPTIONS]	S-S9C3WK
M75[U,H]C5S-WCS[ALL OPTIONS]	S-1LXCTS
M75[U,H]CN-WCS[ALL OPTIONS]	S-4V0JKH
M75[U,H]CW-WCS[ALL OPTIONS]	S-JNBK51

#### HIGH OUTPUT: 100-200W

MODEL #	DLC PRODUCT ID
M100[U,H]C3G-WCS[ALL OPTIONS]	S-JBTFTY
M100[U,H]C3M-WCS[ALL OPTIONS]	S-68FXSM
M100[U,H]C4N-WCS[ALL OPTIONS]	S-47RWNX
M100[U,H]C4W-WCS[ALL OPTIONS]	S-MX80HM
M100[U,H]C5S-WCS[ALL OPTIONS]	S-8KY8TG
M100[U,H]CN-WCS[ALL OPTIONS]	S-BDSL1R
M100[U,H]CW-WCS[ALL OPTIONS]	S-2SKLGX
M125[U,H]C3G-CS[ALL OPTIONS]	S-SQ8HM4
M125[U,H]C3M-CS[ALL OPTIONS]	S-V6D8BM
M125[U,H]C4N-CS[ALL OPTIONS]	S-08SYYJ
M125[U,H]C4W-CS[ALL OPTIONS]	S-92BH3N
M125[U,H]C5S-CS[ALL OPTIONS]	S-KD2X5P
M125[U,H]CN-CS[ALL OPTIONS]	S-NTVP34
M125[U,H]CW-CS[ALL OPTIONS]	S-V5HGLZ
M150[U,H]C3G-WCS[ALL OPTIONS]	S-B8P46T
M150[U,H]C3M-WCS[ALL OPTIONS]	S-V2BZMD
M150[U,H]C4N-WCS[ALL OPTIONS]	S-YZ1PKY
M150[U,H]C4W-WCS[ALL OPTIONS]	S-P927CD
M150[U,H]C5S-WCS[ALL OPTIONS]	S-2Q6FB6
M150[U,H]CN-WCS[ALL OPTIONS]	S-M1VW92
M150[U,H]CW-WCS[ALL OPTIONS]	S-ZQ0QBK
M200[U,H]C4N-CS[ALL OPTIONS]	S-B841VQ
M200[U,H]C4W-CS[ALL OPTIONS]	S-S9LO1T

#### VERY HIGH OUTPUT: 200W

MODEL #	DLC PRODUCT ID
M200[U,H]C3G-CS[ALL OPTIONS]	S-NDM17L
M200[U,H]C3M-CS[ALL OPTIONS]	S-X7FTT5
M200[U,H]C5S-CS[ALL OPTIONS]	S-55GCY5
M200[U,H]CN-CS[ALL OPTIONS]	S-SGCVWY
M200[U,H]CW-CS[ALL OPTIONS]	S-30WSNQ

#### VERY HIGH OUTPUT: 300W

MODEL #	DLC PRODUCT ID
M300[U,H]C3G-WCS[ALL OPTIONS]	S-PHWF48
M300[U,H]C3M-WCS[ALL OPTIONS]	S-JMGJ4N
M300[U,H]C4N-WCS[ALL OPTIONS]	S-THJLBB
M300[U,H]C4W-WCS[ALL OPTIONS]	S-QLL5JB
M300[U,H]C5S-WCS[ALL OPTIONS]	S-LSWPMB
M300[U,H]CN-WCS[ALL OPTIONS]	S-VZWHDH
M300[U,H]CW-WCS[ALL OPTIONS]	S-16N1F7

## M Series

### Accessories (Sold Separately)

MODEL NUMBER (FIELD INSTALLABLE)	ORDER CODE	DESCRIPTION	IMAGE
<b>The following quantities per fixture apply for Lenses, Shields and Visors: 22-75W = 1, 100-150W = 2, 200-300W = 4</b>			
L3-M3GCLENS*	112454	M SERIES TYPE 3G CHANGEABLE LENS, FIELD INSTALLABLE, 90° ROTATABLE	
L3-M3MCLENS*	112453	M SERIES TYPE 3M CHANGEABLE LENS, FIELD INSTALLABLE, 90° ROTATABLE	
L3-M4NCLENS*	112455	M SERIES TYPE 4N CHANGEABLE LENS, FIELD INSTALLABLE, 90° ROTATABLE	
L3-M4WCLENS*	112456	M SERIES TYPE 4W CHANGEABLE LENS, FIELD INSTALLABLE, 90° ROTATABLE	
L3-M5SCLENS*	112457	M SERIES TYPE 5 SQUARE/FLOOD WIDE CHANGEABLE LENS, FIELD INSTALLABLE	
L3-MNCLENS*	112459	M SERIES TYPE FLOOD NARROW (4X4/27°) CHANGEABLE LENS, FIELD INSTALLABLE	
L3-MWCLENS*	112458	M SERIES TYPE 5 LOW GLARE/FLOOD WIDE (6X6/100°) CHANGEABLE LENS, FIELD INSTALLABLE	
M-BLSV2*	112451	BACK LIGHT SHIELD M SERIES, BLACK, FIELD INSTALLABLE	
M-VCLV2*	112452	M SERIES VISUAL COMFORT LENS, FIELD INSTALLABLE	
M-VISORV2-B	112450	HALF VISOR FOR M SERIES, BRONZE, FIELD INSTALLABLE	
VW-BLH	112449	VARIABLE WALL MOUNT LOWER HALF, BRONZE, ATTACHES TO "X" MOUNT	
FW-B	112460	FIXED WALL MOUNT, BRONZE (REMOVE UPPER KNUCKLE TO INSTALL)	
AE-FLH	111983	LOWER KNUCKLE FLEXIBLE ARM MOUNTING, BRONZE, ATTACHES TO "X" MOUNT, FITS SQUARE & ROUND POLES	
AE-KLH	111984	LOWER KNUCKLE SLIPFITTER MOUNTING, BRONZE, ATTACHES TO "X" MOUNT	
AE-SAB	111217	STRAIGHT ARM MOUNTING, BRONZE, FITS SQUARE & ROUND POLES (REMOVE UPPER KNUCKLE TO INSTALL)	
MAE-TSB	112461	TRUNNION SWIVEL MOUNT, BRONZE (REMOVE UPPER KNUCKLE TO INSTALL)	

# M Series

## Accessories – Controls (Sold Separately)

ORDER CODE	MODEL NUMBER	DESCRIPTION	IMAGE
96268	MLRTLPCRSP	SHORTING CAP FOR NEMA TWIST LOCK PHOTOCELL RECEPTACLE (3, 5 OR 7 PIN), REQUIRES RPC OR PR7 FIXTURE OPTION	
105038	PCTL-UNV	TWIST-LOCK ELECTRONIC PHOTOCONTROL 120/208/240/277V (USED WITH RPC OR PR7 OPTION, NOT C-MAX)	
105866	PCTL-HV	TWIST-LOCK ELECTRONIC PHOTOCONTROL 480V (USED WITH RPC OR PR7 OPTION, NOT C-MAX)	
<b>c-Max Basic</b>			
105567	CN-REMOTE	C-MAX REMOTE CONTROL, AT LEAST 1 PER PROJECT TO PROGRAM MOTION SENSOR	
105569	CN-RDPCB <sup>†</sup>	C-MAX PHOTOCELL NODE ROUND, BRONZE, IP66, USED WITH CONTROLS READY FIXTURES	
111456	CN-RDMSB-V2 <sup>†*</sup>	C-MAX CONTROL NODE ROUND, PIR MOTION SENSOR/PHOTOCELL, BRONZE, IP66, USED WITH CONTROLS READY FIXTURES	
<b>c-Max Network<sup>**</sup></b>			
105897	NN-RDB	NETWORK NODE ROUND, BRONZE	
111459	NN-RDMPBXR	NETWORK NODE ROUND, PIR MOTION SENSOR, PHOTOCELL, BLACK, EXTENDED (XR) RANGE	
106391	NN-RDW	NETWORK NODE ROUND, WHITE	

<sup>†</sup> Requires 1.5M Allen wrench  
<sup>\*</sup> Requires at least 1 remote control (CN-REMOTE) per project to program  
<sup>\*\*</sup> Requires c-Max App



# M Series

## Specifications: 15-75W

	M30	M22	M30	M42	M55	M75
Nominal Wattage (W)	15	22	15/22/30	42	30/42/55	42/55/75
CCT	Selectable between 3000K, 4000K or 5000K					
CRI	≥ 70 (80 available as a special order)					
Lumens Type 3G	2,390-2,580	3,650-3,760	4,960-5,110	6,150-7,130	8,200-8,860	10,920-11,760
BUG Rating	B1-U0-G0	B1-U0-G0	B1-U0-G0	B2-U0-G1	B2-U0-G1	B3-U0-G1
Lumens Type 3M	2,280-2,470	3,490-3,590	4,740-4,890	5,880-6,820	7,850-8,470	10,440-11,240
BUG Rating	B1-U0-G1	B1-U0-G1	B1-U0-G1	B2-U0-G2	B2-U0-G2	B2-U0-G2
Lumens Type 4N	2,260-2,450	3,460-3,560	4,690-4,840	5,830-6,760	7,770-8,390	10,340-11,130
BUG Rating	B1-U0-G1	B1-U0-G1	B1-U0-G1	B1-U0-G2	B1-U0-G2	B2-U0-G2
Lumens Type 4W	2,150-2,330	3,290-3,380	4,460-4,600	5,540-6,420	7,390-7,970	9,830-10,590
BUG Rating	B1-U0-G1	B1-U0-G2	B1-U0-G2	B1-U0-G2	B2-U0-G3	B2-U0-G3
Lumens Type 5S	2,360-2,550	3,610-3,720	4,900-5,050	6,080-7,050	8,110-8,750	10,790-11,620
BUG Rating	B2-U0-G1	B2-U0-G1	B3-U0-G1	B3-U0-G1	B3-U0-G1	B3-U0-G2
Flood Beam Spread	7x7 (116°x138°)					
Lumens Type N	2,490-2,700	3,810-3,920	5,170-5,330	6,900-7,310	8,560-9,240	11,390-12,260
Flood Beam Spread	4x4 (29°x29°)					
Lumens Type W (5G)	2,380-2,580	3,650-3,750	4,950-5,100	6,630-7,030	8,180-8,840	10,900-11,740
BUG Rating	B1-U0-G0	B2-U0-G1	B2-U0-G1	B2-U0-G1	B3-U0-G1	B3-U0-G1
Flood Beam Spread	6x7 (97°x113°)					
Efficacy	144-180	148-182	144-180	132-177	132-177	133-179
Dimming	0-10V and High-end trim (with c-Max Controls)					
Power Factor	≥ 90					
Input Voltage	120-277V					120-277V, 277-480V
Surge Protection	Standard: 4kV, Option for 20kA (RPC/PR7 not available with 20kA Option)			Standard: 4kV		Standard 6kV+10kA (120-277V)/20kA (277-480V), option 20kA(120-277V), RPC/PR7 N/A with 10 or 20 kA
Lumen Maintenance (L70) hrs	>100,000 hours					
Housing & Mounting	Die Cast Aluminum with corrosion resistant powder coat finish					
Lens	Impact resistant, UV stabilized Polycarbonate					
Mounting	Standard is X (upper knuckle with 4' SO cord attached). Choice to field install arm, slipfitter, trunnion or wall to the upper half knuckle (X) (see accessories). See order matrix - Straight Arm (A), Flexible Arm (F), 2 3/8" OD Slipfitter (K), Trunnion (T), Fixed Wall (W) or Variable Wall (V). Arms will fit both square and round poles. Battery backup factory installed.					
EPA (sq ft) 0° (Horizontal) /90° (Vertical)	Slipfitter: Horizontal 0.37/Vertical 1.12		Arm: Horizontal 0.47/30° 0.61		Trunnion: Horizontal 0.31/Vertical 1.13	
Operating Temperature	-40°F to 122°F (-40°C to 50°C)					
Weight	9.75lbs/4.4kg					
Listings	DLC Premium, UL, FCC, 3G ANSI vibration (Arms, Slipfitter and Trunnion)					
Environment	IP65, Wet Location, IK08					
Warranty	10 Years. Check <a href="http://maxlite.com/warranties">maxlite.com/warranties</a> for details.					



# M Series

## Specifications: 100-300W

	M100	M125	M150	M200	M300	M300
Nominal Wattage (W)	55/75/100	125	100/125/150	200	250	200/250/300
CCT	Selectable between 3000K, 4000K or 5000K					
CRI	≥ 70 (80 available as a special order)					
Lumens Type 3G	16,020 - 16,940	18,070-21,060	21,330-23,200	31,380-33,080	35,320-41,500	41,650-45,710
BUG Rating	B3-U0-G1	B3-U0-G1	B3-U0-G2	B4-U0-G2	B4-U0-G2	B4-U0-G2
Lumens Type 3M	15,320 -16,210	17,290-20,150	20,400-22,190	30,020-31,640	33,780-39,750	39,840 - 43,720
BUG Rating	B3-U0-G2	B3-U0-G3	B3-U0-G3	B4-U0-G4	B4-U0-G4	B4-U0-G5
Lumens Type 4N	15,170 - 16,050	17,120-19,950	20,200-21,970	29,720-31,320	33,320-41,500	39,440 - 43,290
BUG Rating	B2-U0-G2	B2-U0-G3	B3-U0-G4	B3-U0-G4	B2-U0-G4	B3-U0-G5
Lumens Type 4W	14,420 - 15,260	16,270-18,970	19,200-20,890	28,260-29,780	31,800-37,500	37,500 - 41,160
BUG Rating	B3-U0-G3	B3-U0-G4	B3-U0-G5	B3-U0-G5	B4-U0-G5	B4-U0-G5
Lumens Type 5S	15,830 - 16,750	17,860-20,820	21,080-22,930	31,020-32,690	34,910-40,990	41,160 - 45,180
BUG Rating	B4-U0-G2	B4-U0-G2	B4-U0-G2	B5-U0-G3	B5-U0-G3	B5-U0-G4
Flood Beam Spread	7x7 (116°x138°)					
Lumens Type N	16,710 - 17,680	18,850-21,970	22,250-24,210	32,740-34,500	36,840-43,500	43,450 - 47,690
Flood Beam Spread	4x4 (29°x29°)					
Lumens Type W (5G)	15,990 - 16,920	18,050-21,030	21,290-23,170	31,330-33,020	35,260-41,500	41,580 - 45,640
BUG Rating	B4-U0-G1	B4-U0-G1	B4-U0-G1	B5-U0-G2	B5-U-G2	B5-U0-G2
Flood Beam Spread	6x7 (97°x113°)					
Efficacy	146-189	130 - 176	130 - 176	145-187	131-180	127 - 174
Dimming	0-10V and High-end trim (with c-Max Controls)					
Power Factor	≥ 90					
Input Voltage	120-277V, 277-480V					
Surge Protection	Standard: 6kV + 120-277V 10kA/277-480V 20kA; Option for 120-277V 20kA					
Lumen Maintenance (L70) hrs	>100,000 hours					
Housing & Mounting	Die Cast Aluminum with corrosion resistant powder coat finish					
Lens	Impact resistant, UV stabilized Polycarbonate					
Mounting	Standard is X (upper knuckle with 6' SO cord attached). Choice to field install arm, slipfitter or trunnion (see accessories) or factory install. See order matrix - Straight Arm (A), Flexible Arm (F), 2 3/8" OD Slipfitter (K), Trunnion (T), Fixed Wall (W) or Variable Wall (V). Arms will fit both square and round poles. Wall mounts and Battery backup factory installed.					
EPA (sq ft) 0° (Horizontal) /90° (Vertical)	Slipfitter: Horizontal 0.37/Vertical 1.92 Arm: Horizontal 0.47/30° 1.04 Trunnion: Horizontal 0.31/Vertical 1.93			Slipfitter: Horizontal 0.50/Vertical 2.83 Arm: Horizontal 0.59/30° 1.50 Trunnion: Horizontal 0.42/Vertical 2.84		
Operating Temperature	-40°F to 122°F (-40°C to 50°C)					
Weight	13.75lbs/6.25kg			17.5lbs/9kg		
Listings	DLC Premium, UL, FCC, 3G ANSI vibration (Arms, Slipfitter and Trunnion)					
Environment	IP65, Wet Location, IK08					
Warranty	10 Years. Check <a href="http://maxlite.com/warranties">maxlite.com/warranties</a> for details.					

## M Series

### Photometrics: 22W – 55W

#### Isofootcandle:

Each gridline represents one mounting height.  
For mounting heights other than noted, multiply FC by the below factor.

$$\frac{(\text{Chart's Mtg Height})^2}{(\text{Actual Mtg Height})^2}$$

#### Legend

- 0.2 0.2 fc
- 0.5 0.5 fc
- 1 1 fc
- 2 2 fc
- 5 5 fc
- 10 10 fc
- 20 20 fc

### 22W 10' Mounting Height, CCT: 4000K

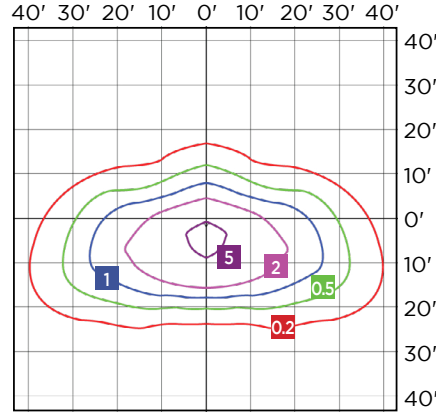

**3M (TYPE 3 MEDIUM)**

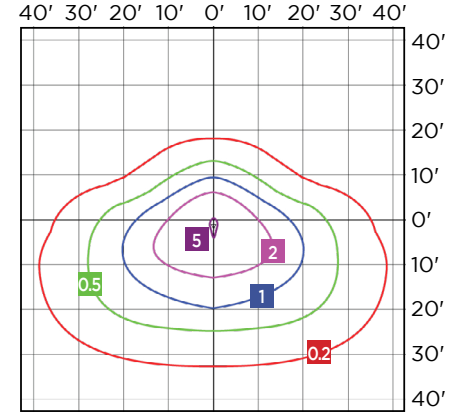

**4W (TYPE 4 WIDE)**

### 30W 12' Mounting Height, CCT: 4000K

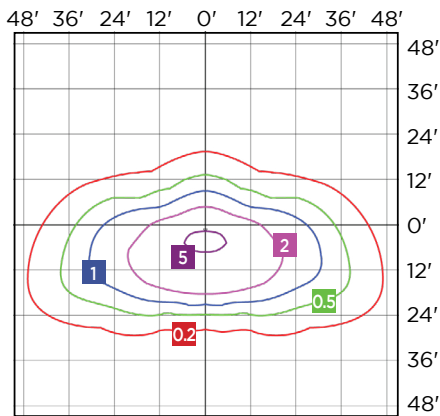

**3M (TYPE 3 MEDIUM)**

### 42W 15' Mounting Height, CCT: 4000K

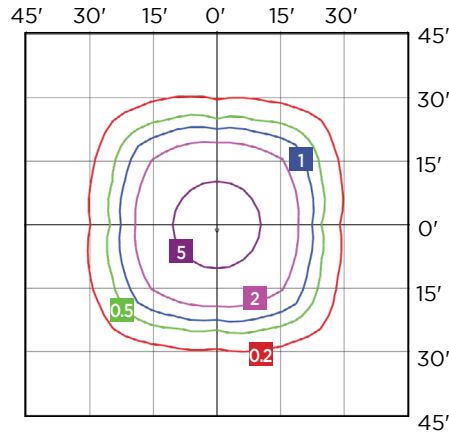

**W (WIDE 6X7)**

### 55W 20' Mounting Height, CCT: 4000K

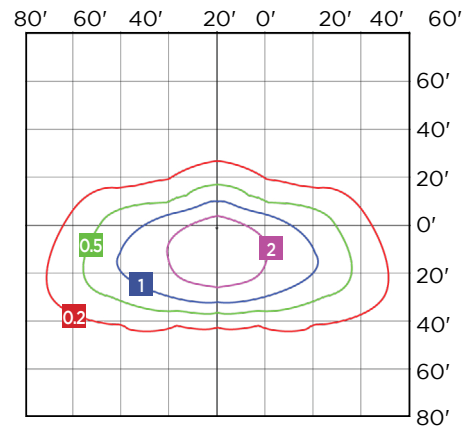

**3M (TYPE 3 MEDIUM)**

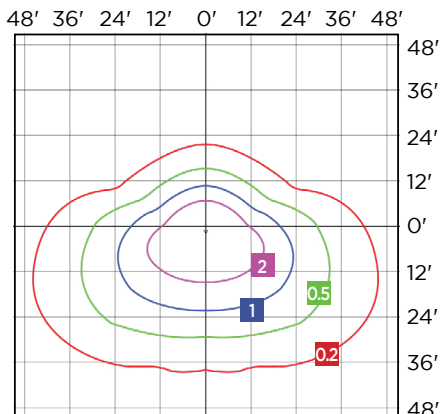

**4W (TYPE 4 WIDE)**

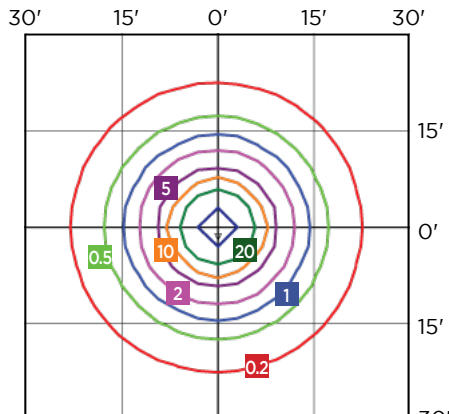

**N (NARROW 4X4)**

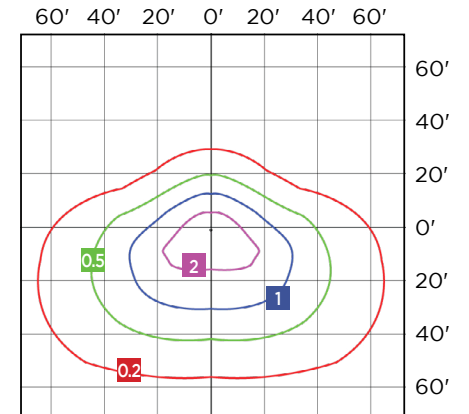

**4W (TYPE 4 WIDE)**

## M Series

### Photometrics: 75W

75W

25' Mounting Height, CCT: 4000K

#### Isofootcandle:

Each gridline represents one mounting height.  
For mounting heights other than noted, multiply FC by the below factor.

$$\frac{(\text{Chart's Mtg Height})^2}{(\text{Actual Mtg Height})^2}$$

#### Legend

0.2	0.5	1	2	5	10	20
0.2 fc	0.5 fc	1 fc	2 fc	5 fc	10 fc	20 fc

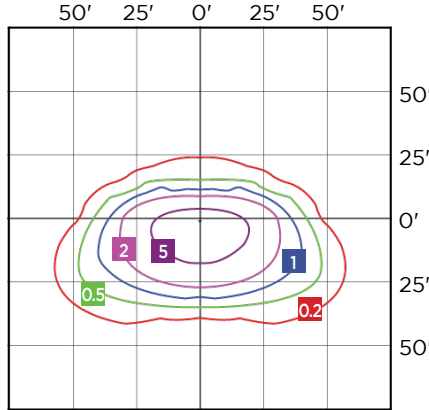

3G (TYPE 3 LOW GLARE)

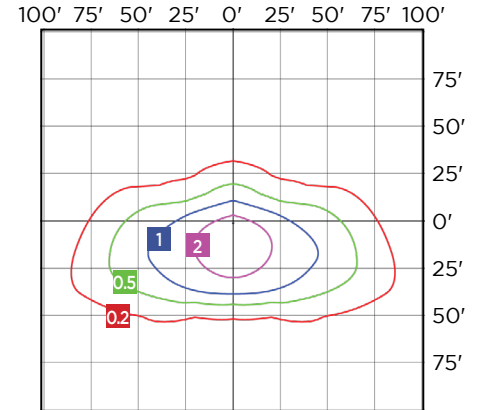

3M (TYPE 3 MEDIUM)

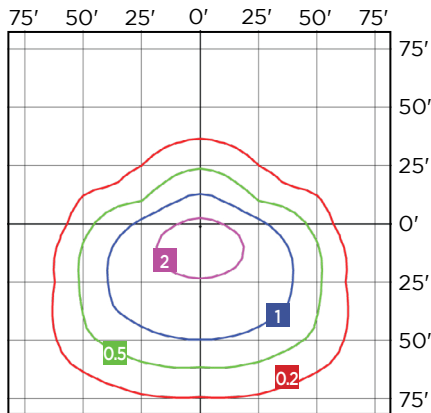

4N (TYPE 4 NARROW)

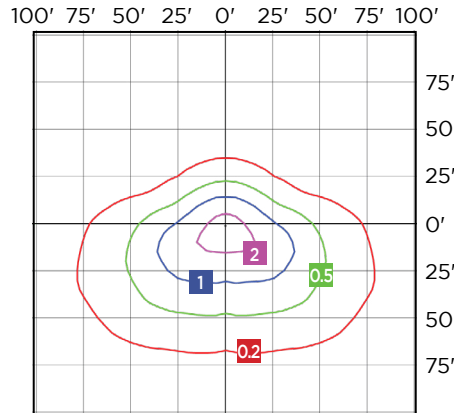

4W (TYPE 4 WIDE)

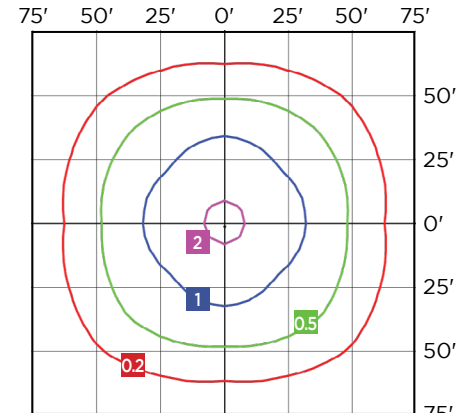

5S (TYPE 5 SQUARE/WIDE 6X7)

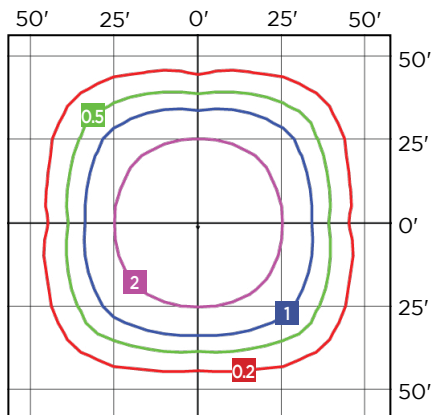

W (WIDE 6X6/TYPE 5 LOW GLARE)

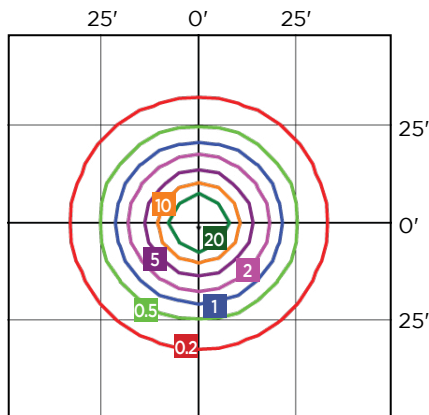

N (NARROW 4X4)

## M Series

### Photometrics: 150W

### 150W 30' Mounting Height, CCT: 4000K

#### Isofootcandle:

Each gridline represents one mounting height.  
For mounting heights other than noted,  
multiply FC by the below factor.

$$\frac{(\text{Chart's Mtg Height})^2}{(\text{Actual Mtg Height})^2}$$

#### Legend

0.2	0.5	1	2	5	10	20
0.2 fc	0.5 fc	1 fc	2 fc	5 fc	10 fc	20 fc

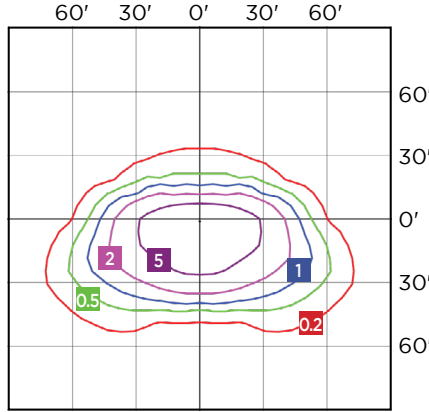

**3G (TYPE 3 LOW GLARE)**

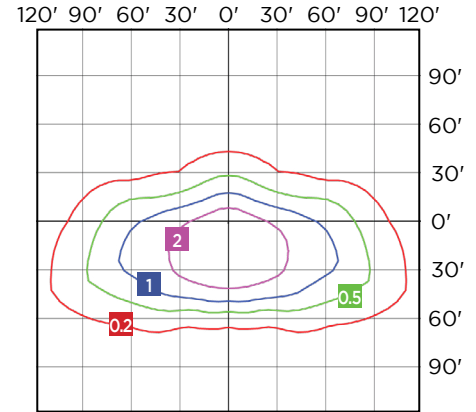

**3M (TYPE 3 MEDIUM)**

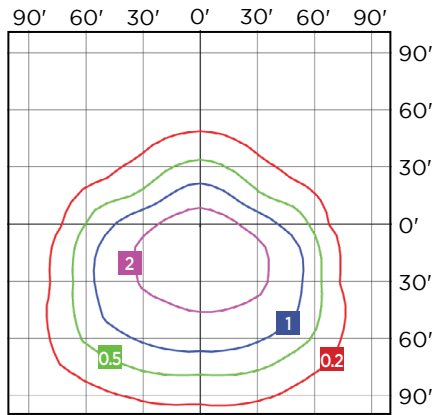

**4N (TYPE 4 NARROW)**

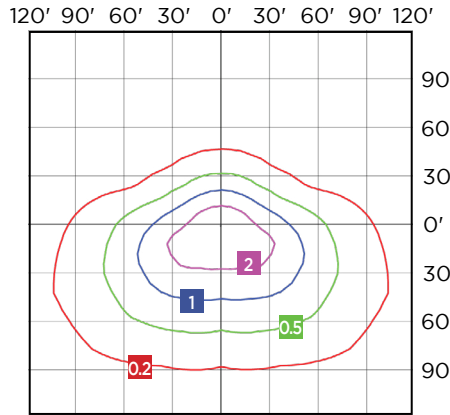

**4W (TYPE 4 WIDE)**

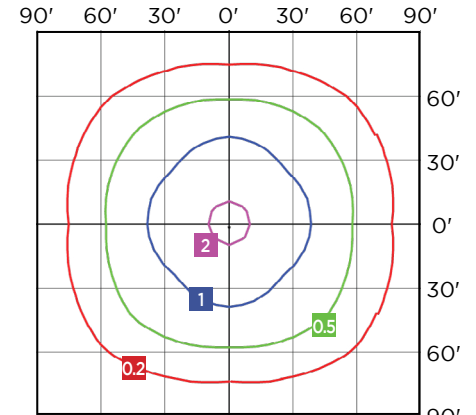

**5S (TYPE 5 SQUARE/WIDE 6X7)**

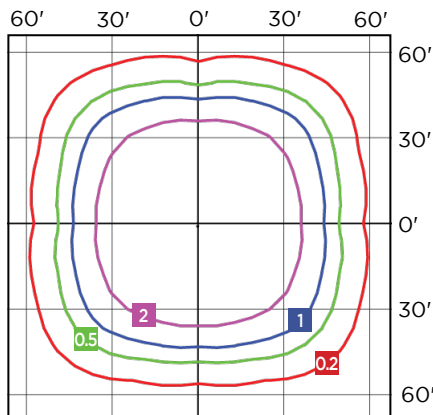

**W (WIDE 6X6/TYPE 5 LOW GLARE)**

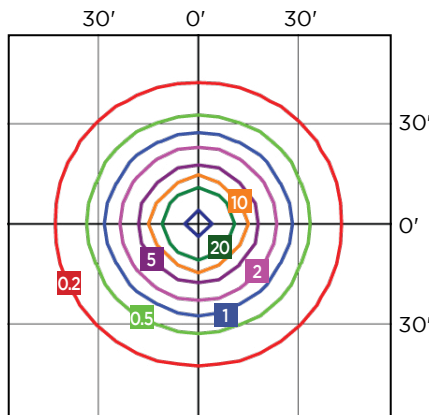

**N (NARROW 4X4)**

## M Series

### Photometrics: 300W

#### Isofootcandle:

Each gridline represents one mounting height.  
For mounting heights other than noted,  
multiply FC by the below factor.

$$\frac{(\text{Chart's Mtg Height})^2}{(\text{Actual Mtg Height})^2}$$

#### Legend

0.2	0.5	1	2	5	10	20	50
0.2 fc	0.5 fc	1 fc	2 fc	5 fc	10 fc	20 fc	50 fc

### 300W 40' Mounting Height, CCT: 4000K

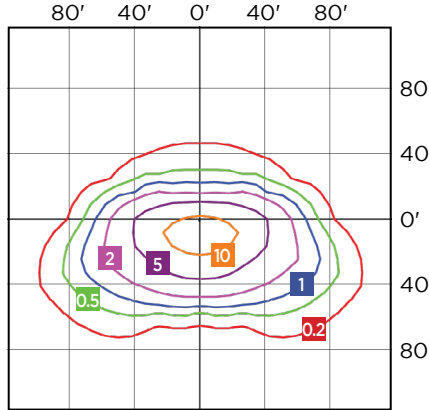

**3G (TYPE 3 LOW GLARE)**

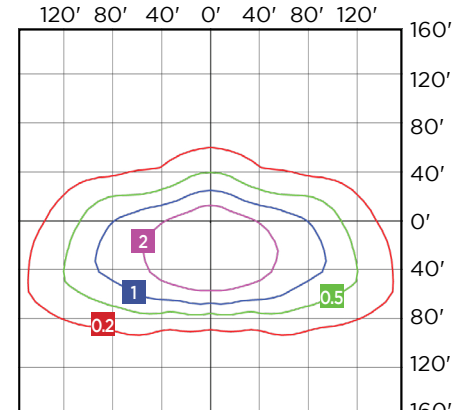

**3M (TYPE 3 MEDIUM)**

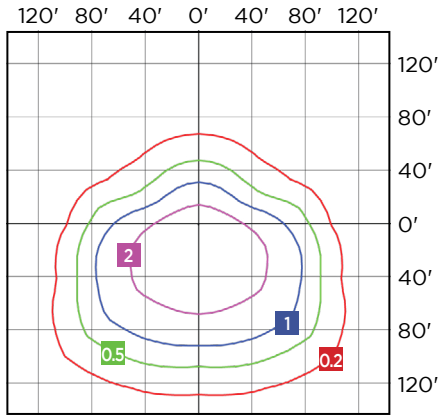

**4N (TYPE 4 NARROW)**

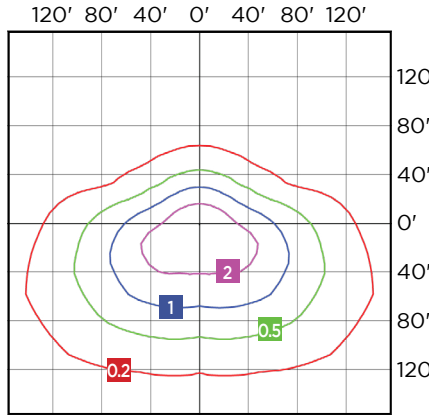

**4W (TYPE 4 WIDE)**

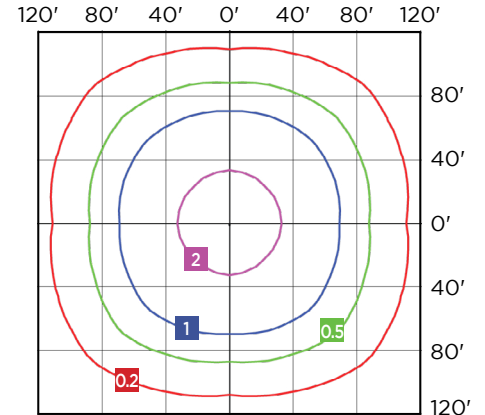

**5S (TYPE 5 SQUARE/WIDE 6X7)**

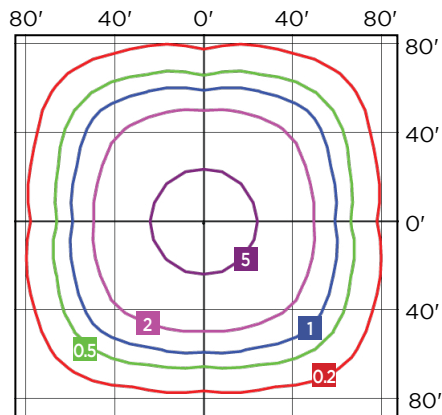

**W (WIDE 6X6/TYPE 5 LOW GLARE)**

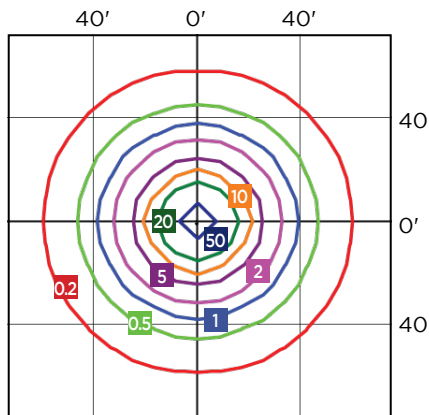

**N (NARROW 4X4)**

## M Series

### Dimensions: 22W-75W models

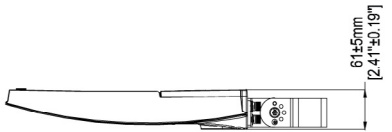
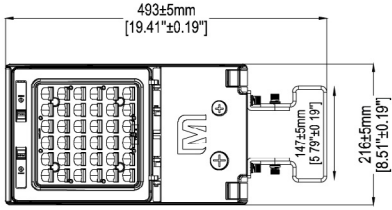

Trunnion

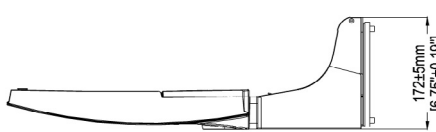
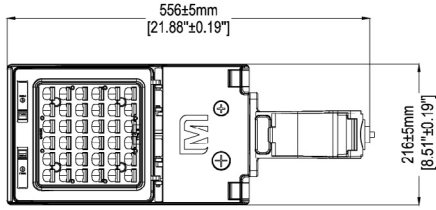

Straight Arm

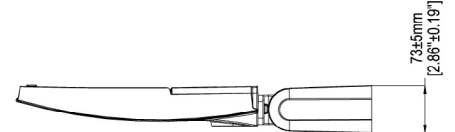
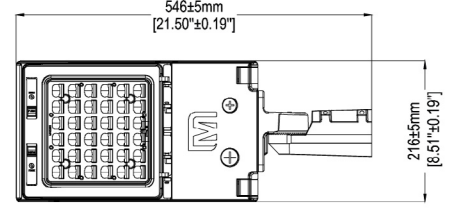

Slipfitter

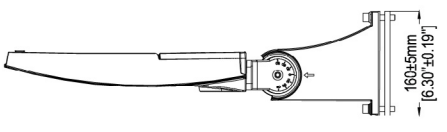
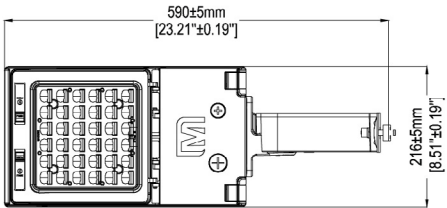

Flexible Arm

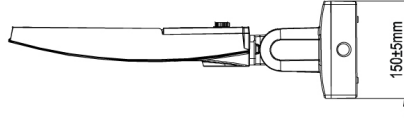
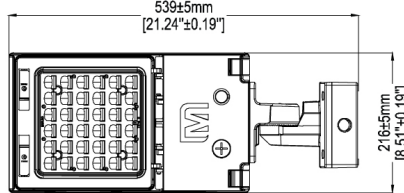

Adjustable Wall Mount

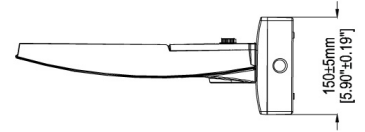
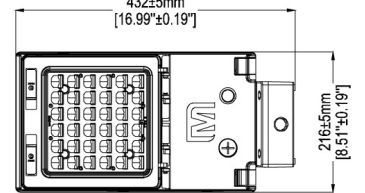

Fixed Wall Mount

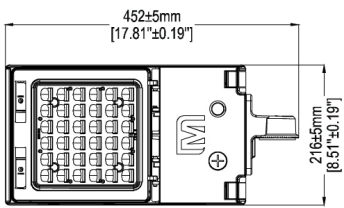

Upper Half Knuckle

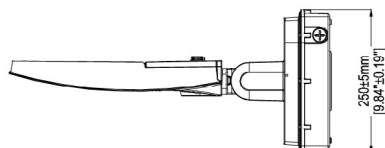
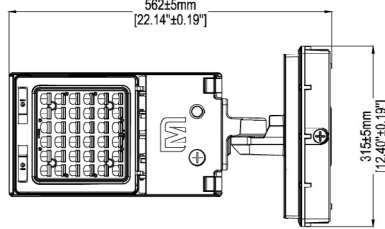

Adjustable BBU Wall Mount

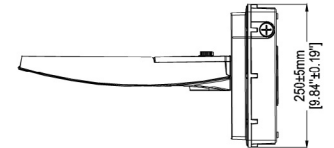
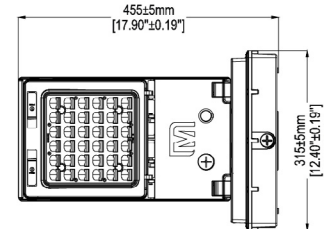

Fixed BBU Wall Mount

## M Series

### Dimensions: 100W-150W models

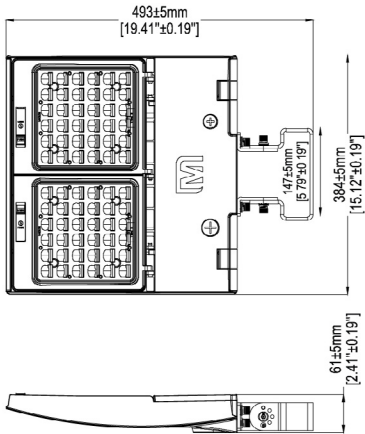

Trunnion

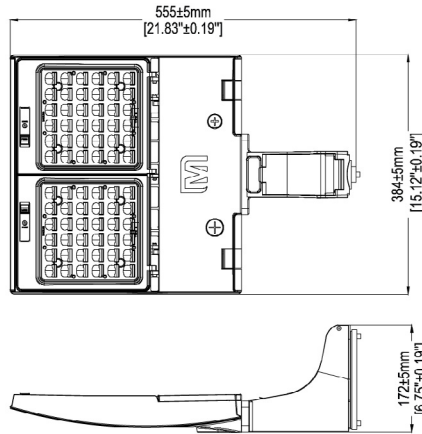

Straight Arm

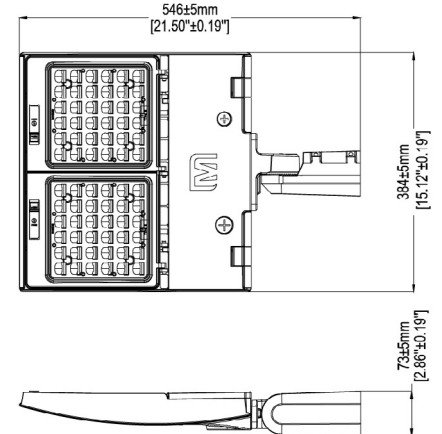

Slipfitter

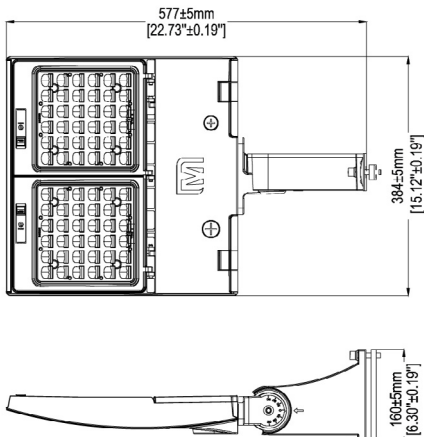

Flexible Arm

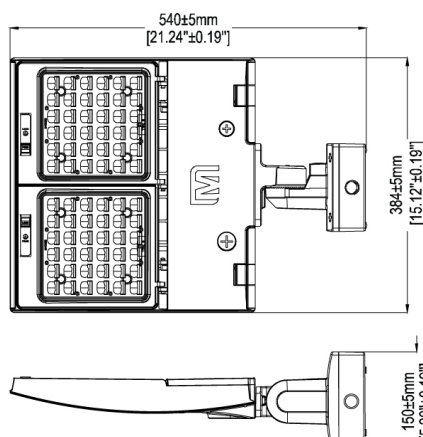

Adjustable Wall Mount

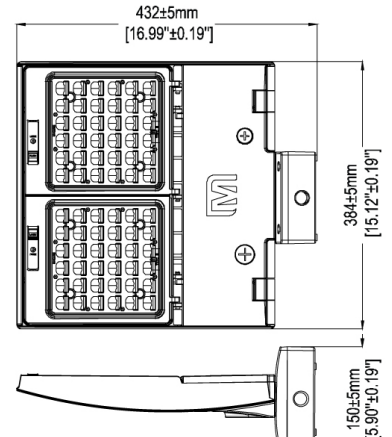

Fixed Wall Mount

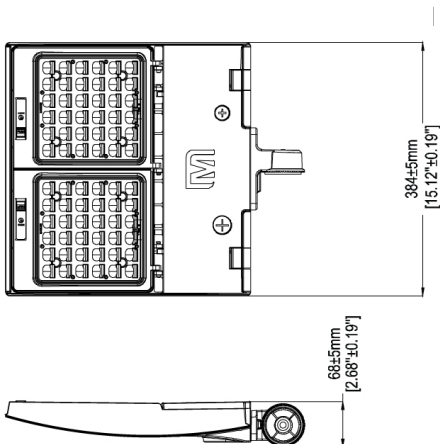

Upper Half Knuckle

## M Series

### Dimensions: 200W-300W models

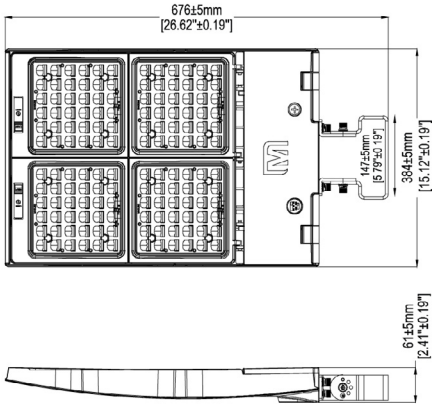

Trunnion

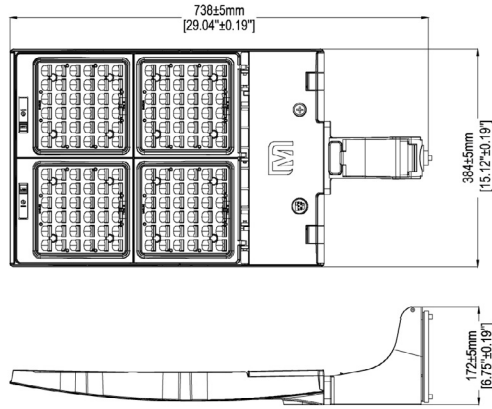

Straight Arm

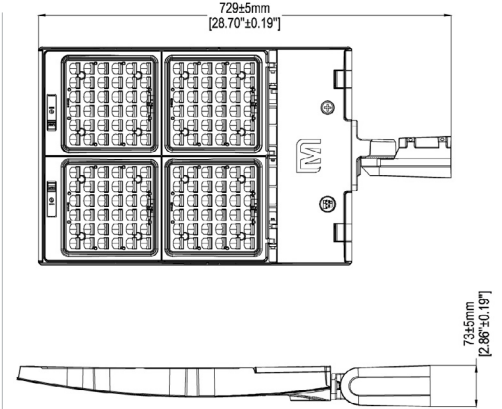

Slipfitter

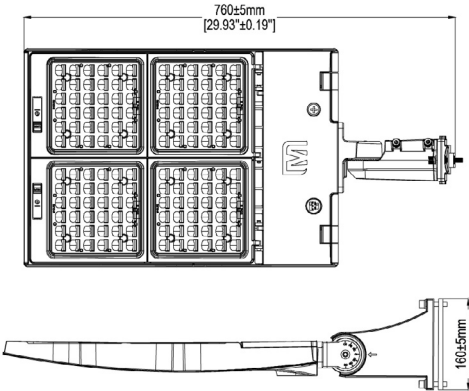

Flexible Arm

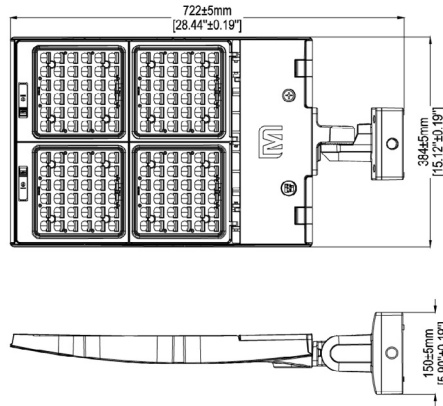

Adjustable Wall Mount

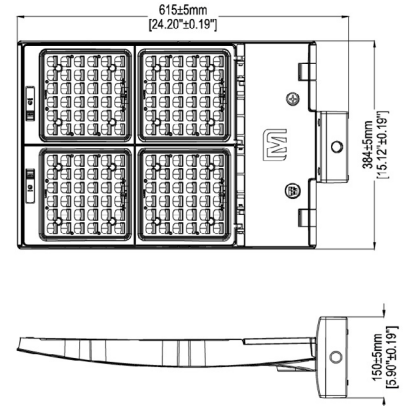

Fixed Wall Mount

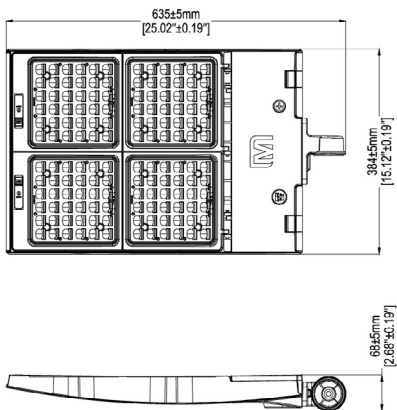

Upper Half Knuckle

## M Series

### Dimensions: Mounting Options Only

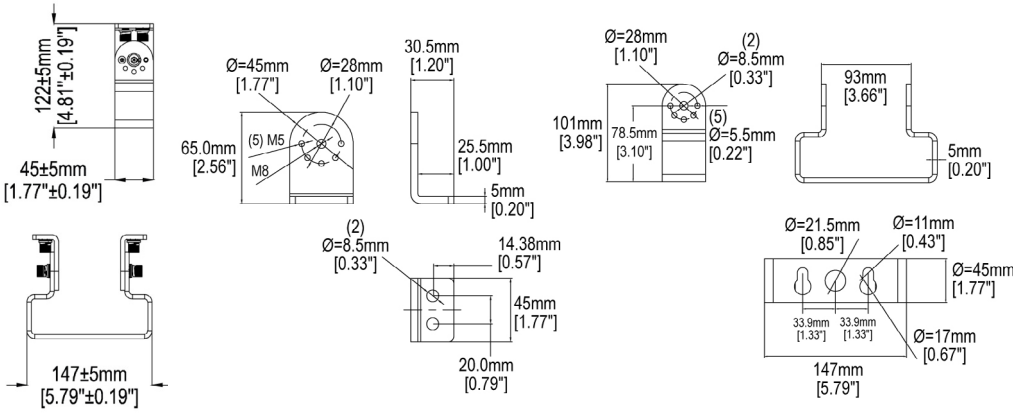

Trunion

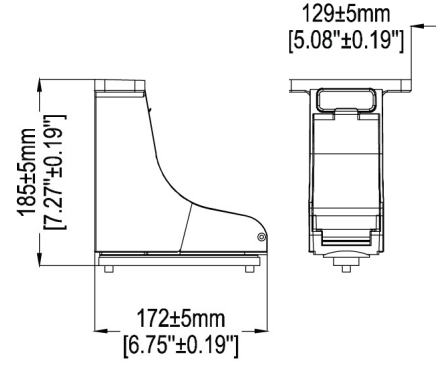

Straight Arm

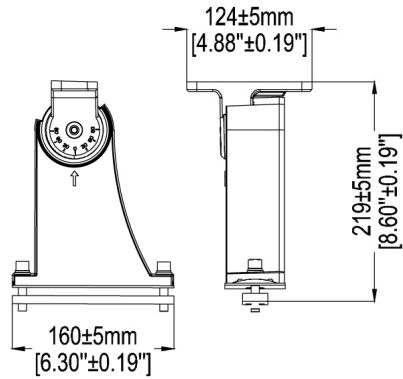

Flexible Arm

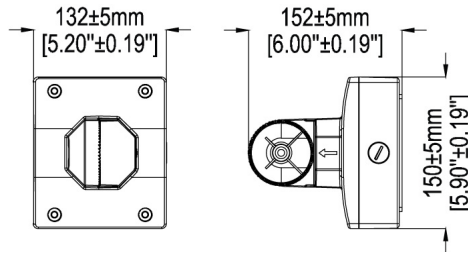

Adjustable Wall Mount

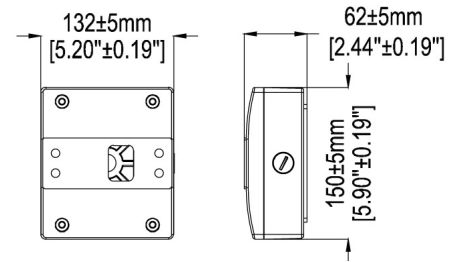

Fixed Wall Mount

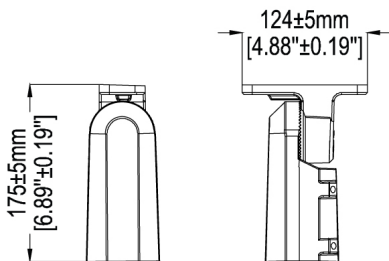

Slipfitter

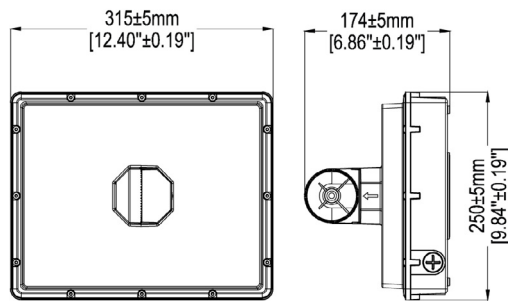

Adjustable BBU Wall Mount

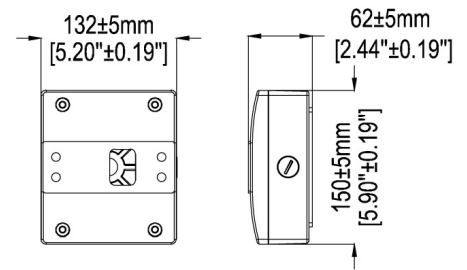

Fixed BBU Wall Mount