

PROJECT NAME: _____ CAT. #: _____
 NOTES: _____ FIXTURE SCHEDULE: _____

Slim Floods



1/2" Threaded Knuckle
(Dedicated CCT)



1/2" Threaded Knuckle
(CCT Selectable)



Yoke Mount
(CCT Selectable)



Slipfitter Mount
(CCT Selectable)



200/300W
(CCT Selectable)

Product Description:

The MaxLite Slim Flood Light family delivers high performance in a small and price-effective package. All versions are available for a variety of mounting applications - 1/2" threaded knuckle, yoke and slipfitter. Many models are CCT and Wattage selectable and include a photocell. A 3-pin NEMA twist lock photocell receptacle with shorting cap is included standard on the 200W and 300W models.

Construction:

- Die cast aluminum housing with corrosion resistant powder coat paint
- Tempered glass lens or UV stabilized polycarbonate lens (see Specification Chart for details)

Controls:

- Photocell or twist lock receptacle with shorting cap included (see Specification Chart for details)
- 200/300W include control base for field installable motion sensor

Installation:

- 15/25/29/50/60W available with 1/2" threaded knuckle or yoke, tenon reducer accessory available for slip fitter applications (see Specification Chart for details)
- 105/140/200/300W models available with either a slipfitter knuckle or yoke mount.

Listings:

- cULus listed for Wet Locations, Outdoor
- IP65
- ANSI 1.5G rated 15-50W, 3G rated 60W+

Ordering Information (DLC5.1 VERSIONS)

FAMILY	WATTAGE	VOLTAGE	BEAM	-	CCT	FINISH	MOUNTING	CONTROLS (INCLUDED STANDARD)
MSF= Maxlite Slim Flood	15= 15W 25= 25W (Selectable 25/20/15) 60= 60W (Selectable 60/40/20) 105= 105W (Selectable 105/95/85) 140= 140W (Selectable 140/120/100) 200= 200W (Selectable 200/180/150) 300= 300W (Selectable 300/280/260)	U= 120-277V H= 277-480V*	W= Wide		CS= CCT Selectable 3/4/5K (15W) WCS= Wattage/CCT Selectable (N/A 15W)	B= Bronze <i>Contact maxlite for additional finishes</i>	KTY= Knuckle 1/2" Threaded & Yoke (15/25/60W), use TR2.37BZ for Slipfitter applications K= Knuckle Slipfitter Y= Yoke	CB= Control Base for field installable motion sensor (200/300W only) PC= 120-277V photocontrol (15/25/60/105/140W) RPC= 3-pin twist lock receptacle with shorting cap (200/300W)

* 200/300W only

Ordering Information (Non-DLC VERSIONS)

FAMILY	WATTAGE	VOLTAGE	BEAM	-	CCT	FINISH	MOUNTING	CONTROLS
MSF= Maxlite Slim Flood	15= 15W 29= 29W 50= 50W	U= 120-277V	W= Wide N= Narrow (50W only)		30= 3000K 40= 4000K 50= 5000K	B= Bronze <i>Contact maxlite for additional finishes</i>	KT= Knuckle 1/2" Threaded (use TR2.37BZ for Slipfitter applications) K= Knuckle Slipfitter Y= Yoke	<i>For photocell, order JBOX and PC-120277EXT accessories</i>



5-year standard warranty (further details available at www.maxlite.com/warranties) Product may be eligible for a warranty extension to 10 years, for an additional fee. Contact MaxLite for details.



Slim Floods

DLC 5.1 Listing

Order Codes	Model Number	DLC Product ID	DLC Category	Wattage	CCT
108575	MSF15UW-CSBKTYPC	S-3ID1GP	Outdoor Luminaires - Architectural Flood and Spot Luminaires	15.5W	3000K/4000K/5000K
108576	MSF25UW-WCSBKTYPC	S-CVRS9H		25.5W	
108582	MSF60UW-WCSBKTYPC	S-EK4CZD		59.5W	
108584	MSF105UW-WCSBKPC	S-FCGR1S		103.9W	
109118	MSF105UW-WCSBYPC	S-FCGR1S		103.9W	
108583	MSF105UW-CSBYPC	S-EU1NLQ		103.9W	
108586	MSF140UW-WCSBKPC	S-HBPXTD		139.9W	
108585	MSF140UW-WCSBYPC	S-HBPXTD		139.9W	
108593	MSF200UW-WCSBKCBRPC	S-R2EXZJ		203.9W	
108587	MSF200UW-WCSBYCBRPC	S-R2EXZJ		203.9W	
108597	MSF300UW-WCSBKCBRPC	S-XVWCF2		309.8W	
108596	MSF300UW-WCSBYCBRPC	S-XVWCF2		309.8W	
108595	MSF200HW-WCSBKCBRPC	S-R9YN73		201.3W	
108594	MSF200HW-WCSBYCBRPC	S-R9YN73		201.3W	
108604	MSF300HW-WCSBKCBRPC	S-YJS4BP		304.2W	
108598	MSF300HW-WCSBYCBRPC	S-YJS4BP		304.2W	



Slim Floods

Specifications	15W	25W**	29W	50W	60W**
Power Consumption (W)	15	25.5 (20/15W)	29.5	49.5	59.5 (40/20W)
Lumens (lm)	1,850-2,090	3,480-3,760	3,400-3,430	6,270-6,700	7,790-8,380
Efficacy (lm/w)	123-139	136-147	115-116	127-135	131-141
CRI	>80 (CCT Selectable >70)	>70	>80	>80	>70
Color Temperature (K)	Dedicated & Selectable	Selectable 3/4/5K	3K or 4K or 5K	3K or 4K or 5K	Selectable 3/4/5K
Beam Angle	Wide/7x7/109°	Wide/7x7/111°	Wide/7x7/109°	Wide/7x7/109°, Narrow/4x4/30°	Wide/7x7/112°
Voltage	120-277V 50/60Hz				
Surge Protection	2.5KV				4KV
Lumen Maintenance (L 70) hrs	>100,000 hours				
Controls	PC (CCT Selectable version)	PC	Order JBOX and external PC		PC
Housing	Die cast aluminum with corrosion resistant powder coat paint				
Mounting	See below footnote for details*				
Lens	Dedicated CCT Polycarbonate, CCT Select Tempered Glass	Tempered Glass	UV Stabilized Polycarbonate		Tempered Glass
Operating Temperature	-30°C (-22°F) - 40°C (104°F)				
Weight	Dedicated CCT 1.5lbs CCT Select 3lbs	3lbs	4.5lbs	5lbs	
Listings	cULus, FCC, ANSI 1.5G vibration				cULus, FCC, ANSI 3G vibration
DLC	CCT Selectable DLC Premium		Not DLC listed		DLC5.1 Premium
Environment	cULus wet locations, IP65				
Warranty	5 Years				

* Dedicated CCT - 15W 1/2" threaded knuckle (KT), 29/50W choose between 1/2" threaded knuckle (KT) or yoke (Y)
CCT Selectable - 15/25/60W both 1/2" threaded knuckle (KT) and yoke (Y) included
For Slipfitter applications (15-60W) - use KT mount and add tenon reducer accessory

** Wattage Selectable, highest wattage DLC listed. See wattage selectable chart for lower wattage lumens.

Wattage Selectable Lumen Chart

MSF25	20W= 2,740-2,940 lumens	15W= 2,055-2,205 lumens
MSF60	40W= 5,240-5,880 lumens	20W= 2,620-2,940 lumens
MSF105	95W= 12,065-13,395 lumens	85W= 10,795-11,985 lumens
MSF140	120W= 15,360-17,040 lumens	100W= 12,800-14,200 lumens
MSF200	180W= 21,060-23,760 lumens	150W= 17,550-19,800 lumens
MSF300	280W= 35,000-39,480 lumens	260W= 32,500-36,660 lumens



Slim Floods

Specifications

Specifications	70W	90W	105W**	140W**	200W**	300W**
Power Consumption (W)	70.5	90	104 (95/85W)	140 (120/100W)	204 (180/150W)	310 (280/260W)
Lumens (lm)	8,480-9,980	11,320-13,180	13,250-14,140	17,900-19,170	23,940-25,560	38,730-41,880
Efficacy (lm/w)	120-141	125-147	127-136	128-137	117-125	125-135
CRI	>80		>70			
Color Temperature (K)	Selectable 3/4/5K					
Beam Angle	Wide/7x7/115.5°		Wide/7x7/112°		Wide/7x7/120°	Wide/7x7/114°
Voltage	120-277V 50/60Hz				120-277V, 277-480V option	
Surge Protection	4KV		6KV			
Lumen Maintenance (L 70) hrs	>100,000 hours					
Controls	3pin twist lock receptacle with shorting cap		PC		3pin twist lock receptacle with shorting cap and control base for motion sensor	
Housing	Die cast aluminum with corrosion resistant powder coat paint					
Mounting	Choose 2 3/8" OD Knuckle Slipfitter or Yoke					
Lens	UV Stabilized Polycarbonate				Tempered Glass	
Operating Temperature	-40°C (-40°F) - 40°C (104°F)					
Weight	11lbs		12lbs		15lbs	
Listings	cULus, FCC, ANSI 3G vibration					
DLC	Not DLC listed		DLC5.1 Premium			
Environment	cULus wet locations, IP65					
Warranty	5 Years					

** Wattage Selectable, highest wattage DLC listed See wattage selectable chart for lower wattage lumens.

Slim Floods

Accessories

Order Code	Model Number	Description	Image
72055	PCTL-UNV	TWIST-LOCK ELECTRONIC PHOTOCONTROL 120/208/240/277V	
101679	TR2.37BZ	TENON REDUCER CONVERTS 1/2" KNUCKLE THREADED MOUNT (KT) TO 2 3/8" SLIPFITTER KNUCKLE (SK) MOUNT, BRONZE	
104199	MSF15-HALFVISOR	SLIM FLOOD HALF VISOR FOR 15W (Dedicated CCT versions only)	
104200	MSF15-FULLVISOR	SLIM FLOOD FULL VISOR FOR 15W (Dedicated CCT versions only)	
104201	MSF29-HALFVISOR	SLIM FLOOD HALF VISOR FOR 29W	
104202	MSF29-FULLVISOR	SLIM FLOOD FULL VISOR FOR 29W	
104203	MSF50-HALFVISOR	SLIM FLOOD HALF VISOR FOR 50W	
104204	MSF50-FULLVISOR	SLIM FLOOD FULL VISOR FOR 50W	
104205	MSF70/90-HALFVISOR	SLIM FLOOD HALF VISOR FOR 70/90W	
104206	MSF70/90-FULLVISOR	SLIM FLOOD FULL VISOR FOR 70/90W	
104352	GROUNDSTAKE	21" BLACK PVC GROUND STAKE WITH BRONZE DIE CAST CAP, GROUND STABILIZERS BARS AND HARDWARE TO MOUNT TO MOUNT JUNCTION BOX, WHICH ALLOWS ADDING AN EXTERNAL PHOTOCELL	
104350	JBOXB-4TH	JUNCTION BOX WITH 4 1/2" CONDUIT HOLES TOP COVER. PROVIDES MOUNTING FOR FLAT SURFACES AND ADDING EXTERNAL PC (PC-120277EXT)	
101417	PC-120277EXT	EXTERNAL PHOTOCONTROL 120-277V, BLACK FINISH	
96268	MLRTLPCRSP	SHORTING CAP FOR NEMA TWIST LOCK PHOTOCELL RECEPTACLE (3, 5 OR 7 PIN) (70/90/200/300W versions)	
105551	MTGCOVER	DIE CAST ALUMINUM MOUNTING COVER WITH 3X1/2" THREADED CONDUIT HOLES, BRONZE	
109134	MS-HBE-B	MOTION SENSOR/PC, BRONZE FOR 200/300W SLIM FLOODS (MIN 1 HBE-REMOTE REQUIRED TO PROGRAM)	
109135	HBE-REMOTE	REMOTE CONTROL FOR MOTION SENSOR/PC FOR 200/300W SLIM FLOODS	
108915	MSF15-25-CSHALFVISOR	MAXLITE SLIM FLOOD HALF VISOR FOR 15-25W CCT SELECTABLE VERSION	
108918	MSF60-HALFVISOR	MAXLITE SLIM FLOOD HALF VISOR FOR 60W	
108919	MSF105-140-HALFVISOR	MAXLITE SLIM FLOOD HALF VISOR FOR 105-140W	
108921	MSF200-HALFVISOR	MAXLITE SLIM FLOOD HALF VISOR FOR 200W	
108922	MSF300-HALFVISOR	MAXLITE SLIM FLOOD HALF VISOR FOR 300W	



Slim Floods

Product Dimensions:

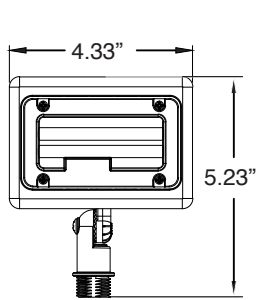

15W 1/2" Threaded Knuckle
(Dedicated CCT)

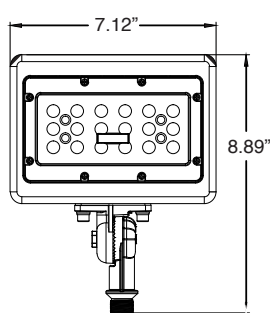

29W 1/2" Threaded Knuckle
(Dedicated CCT)

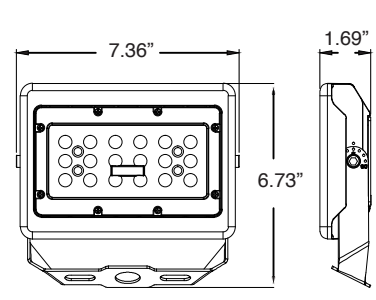

29W Yoke
(Dedicated CCT)

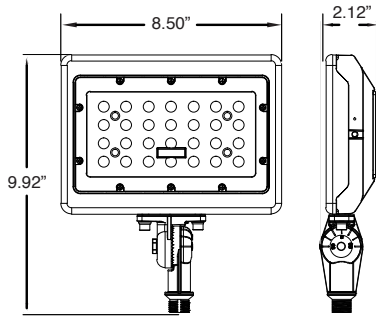

50W 1/2" Threaded Knuckle
(Dedicated CCT)

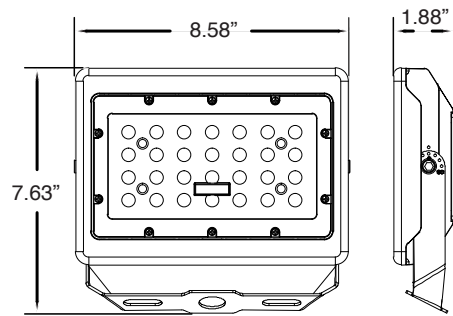

50W Yoke
(Dedicated CCT)

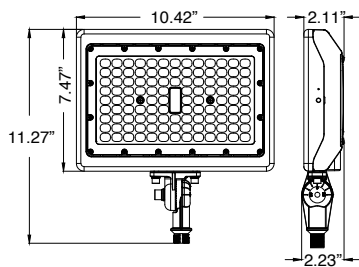

70W/90 1/2" Threaded Knuckle
(CCT Selectable)

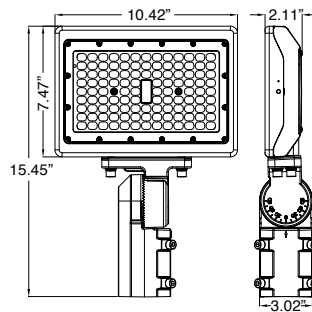

70W/90 Slipfitter Knuckle
(CCT Selectable)

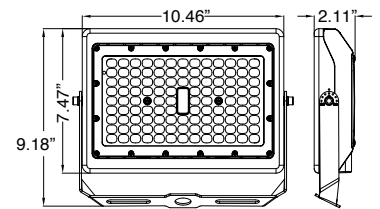

70W/90 Yoke
(CCT Selectable)

Slim Floods

Product Dimensions:

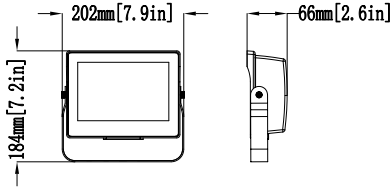

15-25W Yoke (CCT Selectable)

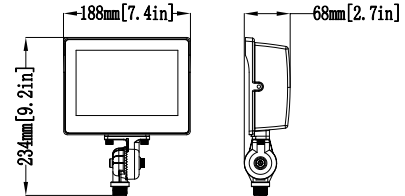

15-25W 1/2" Threaded Knuckle (CCT Selectable)

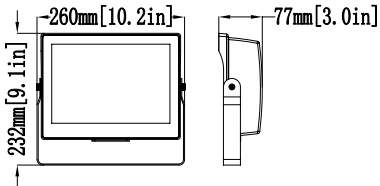

60W Yoke (CCT Selectable)

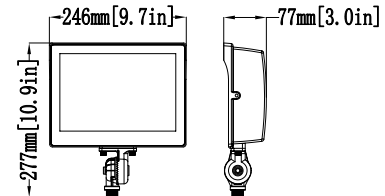

60W Threaded Knuckle (CCT Selectable)

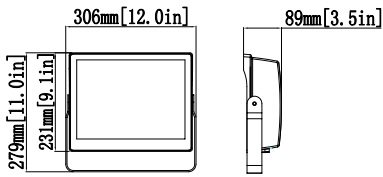

105-140W Yoke (CCT Selectable)

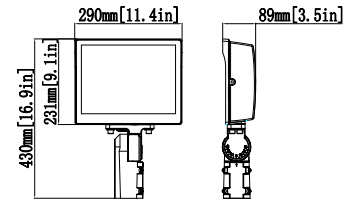

105-140W Slipfitter Knuckle (CCT Selectable)

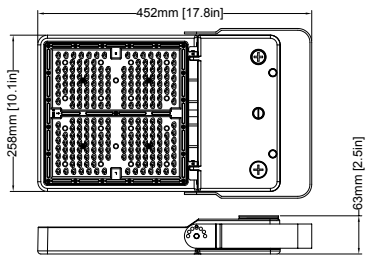

200W Yoke (CCT Selectable)

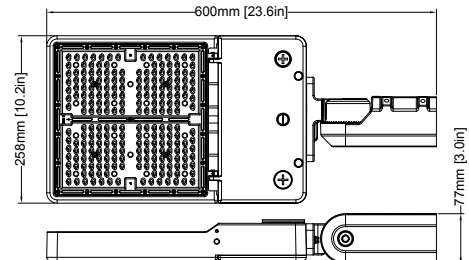

200W Slipfitter Knuckle (CCT Selectable)

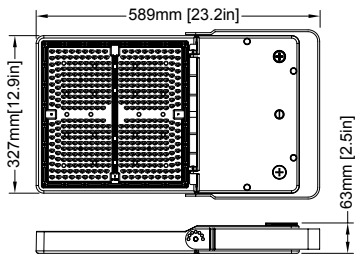

200W Yoke (CCT Selectable)

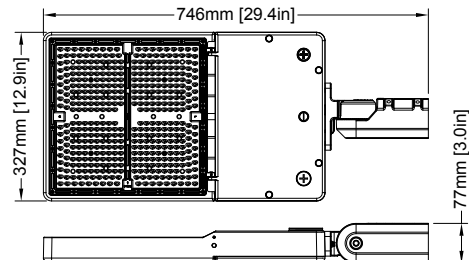

200W Slipfitter Knuckle (CCT Selectable)



Slim Floods

Photometric Layouts*

*Units in FC

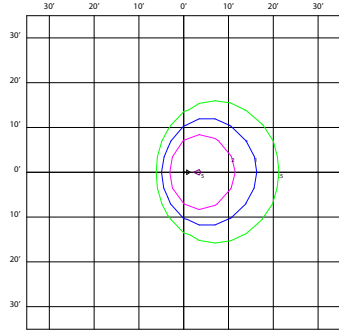

15W
10' Mounting Height (45° tilt)

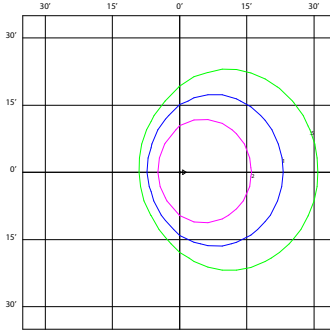

29W
15' Mounting Height (45° tilt)

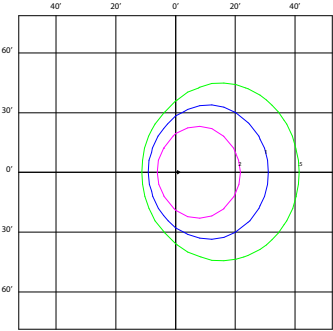

50W
20' Mounting Height (45° tilt)

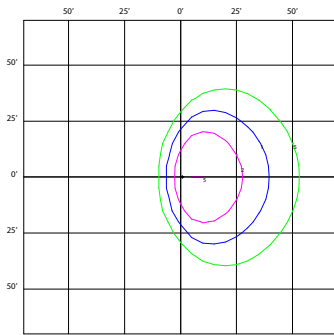

70W
25' Mounting Height (45° tilt)

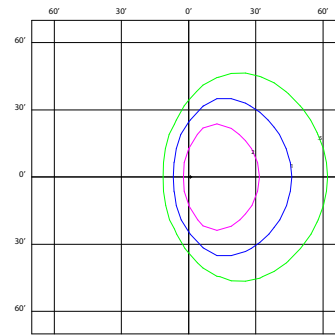

90W
30' Mounting Height (45° tilt)

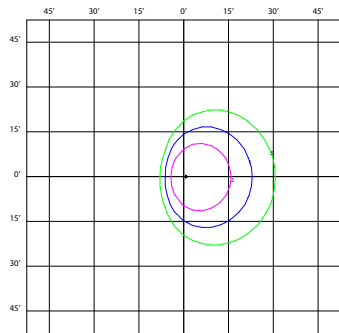

25W
15' Mounting Height (45° tilt)

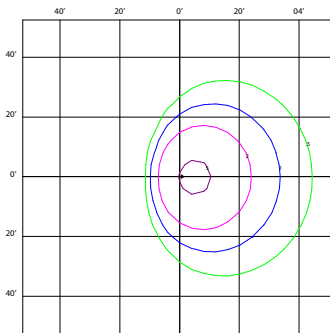

60W
20' Mounting Height (45° tilt)

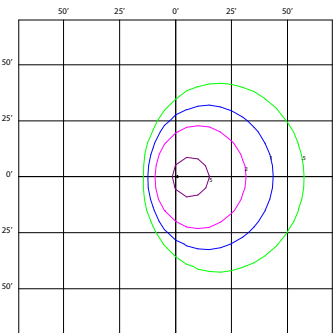

105W
25' Mounting Height (45° tilt)

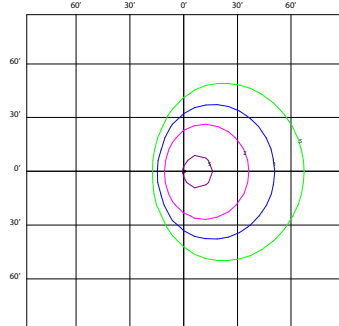

140W
30' Mounting Height (45° tilt)

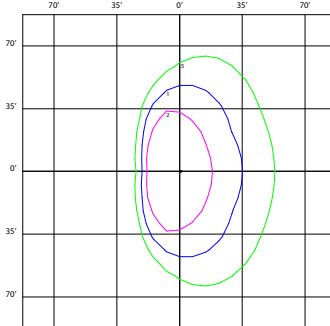

200W
35' Mounting Height (45° tilt)

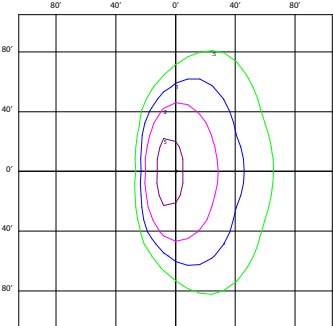

300W
40' Mounting Height (45° tilt)