

## LED T5

### SINGLE-ENDED/ DOUBLE-ENDED POWER COATED GLASS SERIES UL TYPE-B



#### PRODUCT DESCRIPTION:

Offering the versatility of single or double ended wiring options in one product SKU, this LED UL Type-B T5 lamp is an easy retrofit into most common linear fluorescent fixtures with shunted or non-shunted lamp holders (see re-lamping examples provided). In addition to flexible installation features that save installers time and money, the Single Ended/ Double-Ended LED T5 lamp consumes up to 50% less energy than standard fluorescent tubes, providing facilities with long-term operational savings.



#### FEATURES:

- Ballast Bypass (UL Type-B)
- Shatterproof coated glass

#### WARRANTY:

5-year standard warranty (further details available at [www.maxlite.com/warranties](http://www.maxlite.com/warranties)) Product may be eligible for a warranty extension to 10 years, for an additional fee. Contact MaxLite for details.

#### LISTINGS:

- UL listed for Dry/Damp Locations

#### ORDER STRUCTURE

FAMILY	WATTAGE	LAMP TYPE	OPERATION	LENGTH	COLOR TEMPERATURE
L= LED Linear	12= 12W	T5= T5	DE= Single-Ended/Double- Ended Power	2= 2ft	35= 3500K 40= 4000K 50= 5000K
	16= 16W			3= 3ft	
	13 <sup>1</sup> = 13W 25= 25W			4= 4ft	

**NOTES:**  
<sup>1</sup> DLC applies to 13W and 25W models only.





#### STOCKED ITEMS:

ORDER CODE	LENGTH	MODEL NUMBER	ORDER CODE	LENGTH	MODEL NUMBER	DLC PRODUCT ID
105045	2ft	L12T5DE235-CG	105051	4ft	L13T5DE435-CG	PL86SS7GXCP2
105046	2ft	L12T5DE240-CG	105052	4ft	L13T5DE440-CG	PLWCPBD0PMXQ
105047	2ft	L12T5DE250-CG	105053	4ft	L13T5DE450-CG	PLSF4R5LEQ6S
105048	3ft	L16T5DE335-CG	105054	4ft	L25T5DE435-CG	PL2VTV09DCUV
105049	3ft	L16T5DE340-CG	105055	4ft	L25T5DE440-CG	PLT95146UQXH
105050	3ft	L16T5DE350-CG	105056	4ft	L25T5DE450-CG	PLPJFCR2HH34

### SPECIFICATIONS:

ITEM	L12T5DE2xx-CG	L13T5DE4xx-CG	L16T5DE3xx-CG	L25T5DE4xx-CG
NOMINAL WATTAGE (W)	12W	13W	16W	25W
LUMENS (LM)	1500-1600 lm	1600-1700 lm	2000-2100 lm	3400-3500 lm
EQUIVALENCY	24W T5HO	28W T5HE	39W T5HO	54W T5HO
EFFICACY (LM/W)	125/133 lm/W	123-131 lm/W	125/131lm/W	136-140 lm/W
BEAM ANGLE	>280°			
CRI	≥80			
CCT (K)	3500K, 4000K, 5000K			
L70 LIFETIME ( HRS)	≥50,000 Hrs			
VOLTAGE	120-277V			
POWER FACTOR	≥0.90			
OPERATING TEMPERATURE	-4°F to 113°F (-20°C to 45°C)			
LISTINGS	cULus, ETL Sanitation, FCC, RoHS Compliant			
QUALIFICATION - DESIGNLIGHTS CONSORTIUM	-	DLC Standard	-	DLC Standard
ENVIRONMENT	UL listed for Dry/Damp Locations			
WARRANTY	5 Year Warranty			

### ACCESSORIES:

ORDER CODE	MODEL NO	DESCRIPTION	PRODUCT IMAGE
103546	T8B-BBU	BATTERY BACK UP FOR TYPE B LINEAR	
14098784	G5KIT1	1-LAMP WIRING HARNESS FOR LED T5 - BYPASS UL TYPE-B	
14098785	G5KIT2	2-LAMP WIRING HARNESS FOR LED T5 - BYPASS UL TYPE-B	
14098786	G5KIT4	4-LAMP WIRING HARNESS FOR LED T5 - BYPASS UL TYPE-B	
14098787	G5KIT6	6-LAMP WIRING HARNESS FOR LED T5 - BYPASS UL TYPE-B	

\*When using the wiring harness accessory, the installation will be single ended

## WIRING DIAGRAM SINGLE-ENDED CONNECTION

### NON-SHUNTED & SHUNTED LAMP HOLDER

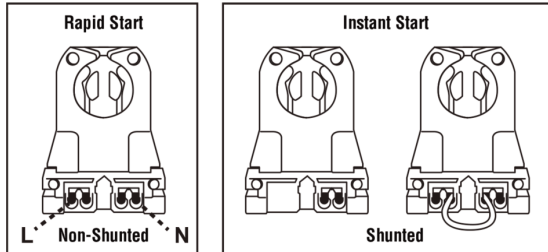

### SINGLE-ENDED CONNECTION



### RETROFIT WITH 1 LAMP

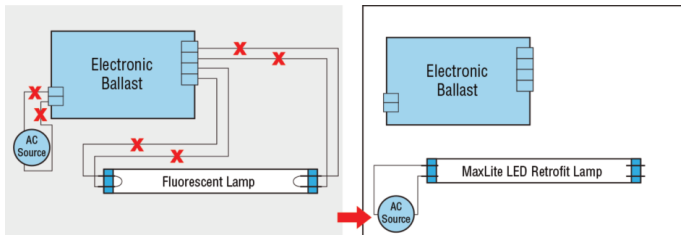

### RETROFIT WITH 2 LAMPS

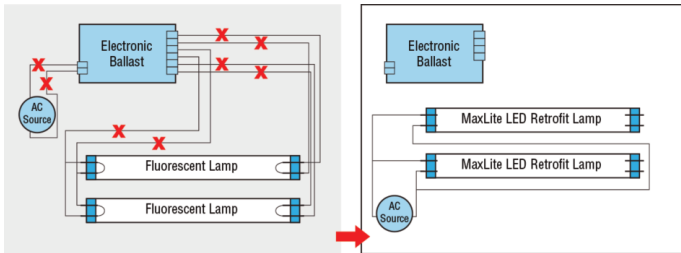

### RETROFIT WITH 3/4 LAMPS

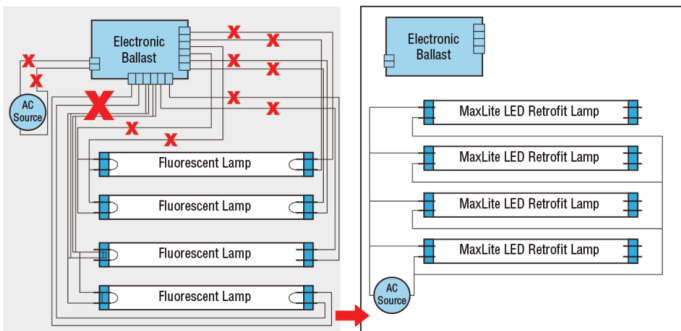

## WIRING DIAGRAM DOUBLE-ENDED CONNECTION

### RELAMPING EXAMPLE

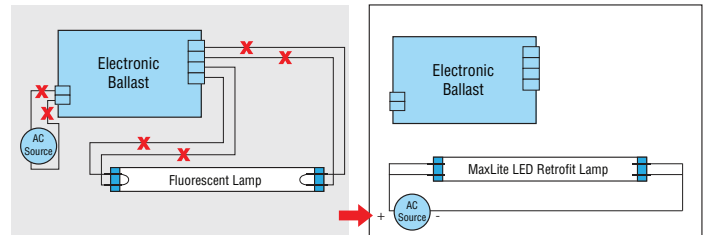

### DOUBLE-ENDED CONNECTION

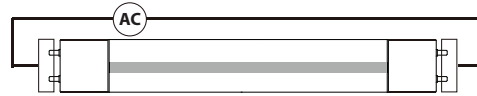

### RETROFIT WITH 1 LAMP

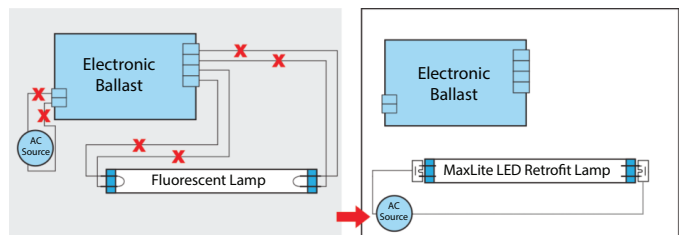

### RETROFIT WITH 2 LAMPS

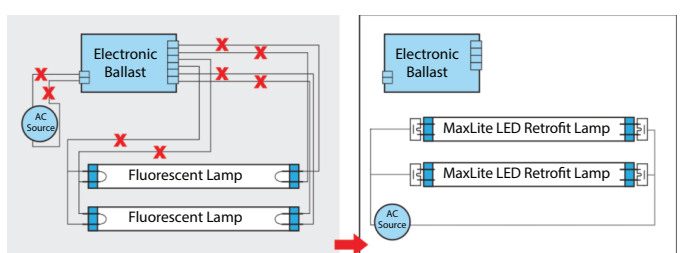

### RETROFIT WITH 3/4 LAMPS

