

PROJECT NAME: _____ CAT. #: _____
 NOTES: _____ FIXTURE SCHEDULE: _____

MLFP Flat Panel Gen 4 Fixed Wattage – 4000K CCT

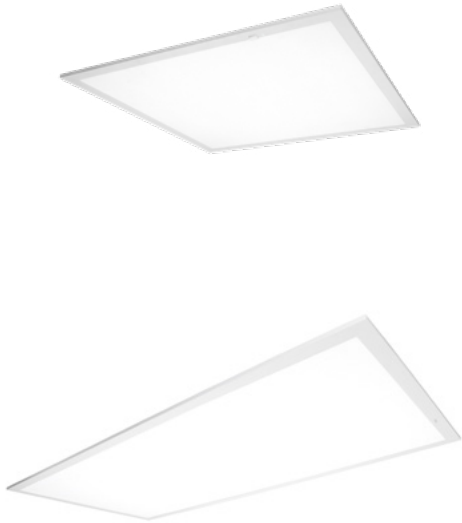

Product Description:

A seamless replacement for 2'x2' and 2'x4' fluorescent fixtures, MaxLite's next-generation LED Flat Panels are designed to lay in drop ceilings in offices, schools, and healthcare applications. The panels are fully dimmable, and may be combined with motion sensors for further energy savings. MaxLite panels deliver all the benefits of LED technology, including a long life with high lumen maintenance, reduced energy consumption and lower maintenance costs.

Features:

- 0-10V Dimmable
- Voltage: 120-277V
- L70 Lumen Maintenance $\geq 100,000$ at 40°C (104°F)
- On EM mode, the fixture output a minimum of 2000 lumens for 90 minutes, when fully charged
- Additional larger J-Box included for easy wiring

Order Structure

FAMILY	SIZE	PANEL TYPE	WATTAGE	CCT	BATTERY BACKUP	BATTERY BACKUP
MLFP= Flat Panel	22= 2'x2'	G4= Backlit	30= 30W	40= 4000K	[BLANK]= None EM= Battery Backup	[BLANK]= None MS= Bi-Level Microwave Motion Sensor (Line Voltage)
	24= 2'x4'		40= 40W			

Stocked Items

ORDER CODE	MODEL NUMBER	DLC PRODUCT ID #	DIMENSION (L" X W" X H")Y
104497	MLFP22G43040	PL308UXST9YM	23.7" x 23.7" x 2.2"
104498	MLFP24G44040	PLG7OHLXAWI5	47.7" x 23.7" x 2.2"







10-year standard warranty with labor allowance (further details available at www.maxlite.com/warranties)

Warranty Limitations: Product must be rated for application per the Product Data Sheet (PDS); operated ≤ 16 hrs; in ambient temperatures -4°F to 77°F. If ambient temperatures fall outside the -4°F to 77°F range, product is warranted for 5 years according to the operating temperature range specified on the PDS. Up to \$25/unit; registration required. Additional coverage may be available for purchase; contact MaxLite. Excludes EM/MS versions; component warranty applies.

MLFP Flat Panel Gen 4

Fixed Wattage – 4000K CCT

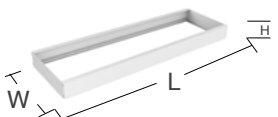
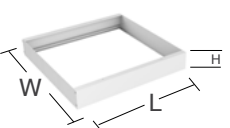
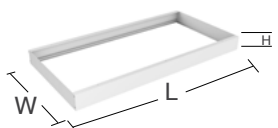
Accessories (SOLD SEPARATELY)

ORDER CODE	MODEL NUMBER	DESCRIPTION	IMAGE
104817	ML14G4FK	Gen 4 1x4' Flat Panel Flange Kit	
104819	ML22G4FK	Gen 4 2x2' Flat Panel Flange Kit	
104820	ML24G4FK	Gen 4 2x4' Flat Panel Flange Kit	
104811	ML14G4SMK	Gen 4 1X4 Flat Panel Surface Mount Kit (47.87" L X 12.32" W X 3.7" H)	
104813	ML22G4SMK	Gen 4 2X2 Flat Panel Surface Mount Kit (23.85" L X 24.97" W X 3.7" H)	
104814	ML24G4SMK	Gen 4 2X4 Flat Panel Surface Mount Kit (47.87" L X 24.97" W X 3.7" H)	
104816	MLG4CHK	Gen 4 Cable Hanging Kit For 1x4 & 2x2 Flat Panel (40" length)	
104848	ML24G4CHK	Gen 4 Cable Hanging Kit For 2x4 Flat Panel - 6 Cables (40" length)	
104891	RMHD05R ²	Remote control for MS option of Fixed Wattage 4000K models	

Sensor

SENSOR	TECHNOLOGY	DIMMING	DAYLIGHT HARVESTING	REMOTE CONTROL	QR CODE
MS for Fixedwattage 4000K models	Microwave motion sensing	Bi-Level	Photoelectric sensor Set point on/off	RMHD05R	

²RMHD05R remote applies to the Microwave Motion Sensor option for fixed wattage 4000K models.

MLFP Flat Panel Gen 4

Fixed Wattage – 4000K CCT

Specifications

	MLFP22G43040
Size	2'X2'
Power Consumption	30W
Lumens Delivered	3390 lm
Efficacy	113 lm/w
CRI	≥80
Color Temperature (K)	4000K
L70 Lumen maintenance	≥100,000 Hrs
Power Factor	>0.9
Input Voltage	120-277V
Comp Dimmer	Designed to be compatible with most 0-10V dimmers
Mounting	Surface mount, Flange mount and Aircraft cables (Information needs to be confirmed)
Operating Temperature	-4°F to 122°F (-20°C to 50°C)
Humidity	20% to 85% RH non-condensing
Certification	cULus Listed, FCC
Material Usage	RoHS Compliant; No Mercury
Environment	Damp/ Dry Location
DesignLight Consortium	DLC Standard
Warranty	10 Years warranty

Specifications

	MLFP24G44040
Size	2'X4'
Power Consumption	40W
Lumens Delivered	4760 lm
Efficacy	114 lm/W
CRI	≥80
Color Temperature (K)	4000K
L70 Lumen maintenance	≥100,000 Hrs
Power Factor	>0.9
Input Voltage	120-277V
Comp Dimmer	Designed to be compatible with most 0-10V dimmers
Mounting	Surface mount, Flange mount and Aircraft cables (Information needs to be confirmed)
Operating Temperature	-4°F to 122°F (-20°C to 50°C)
Humidity	20% to 85% RH non-condensing
Certification	cULus Listed, FCC
Material Usage	RoHS Compliant; No Mercury
Environment	Damp/ Dry Location
DesignLight Consortium	DLC Standard
Warranty	10 Years warranty

MLFP Flat Panel Gen 4 Fixed Wattage – 4000K CCT

MLFP22G43040 & MLFP24G44040

These models come with optional J-Box in every fixture for ease of wiring.

30W - 2X2'

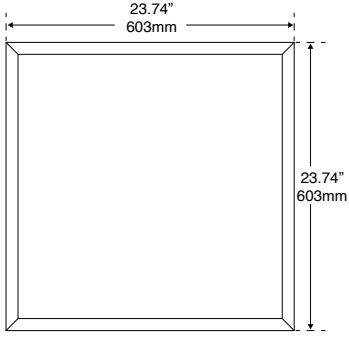

40W - 2X4'

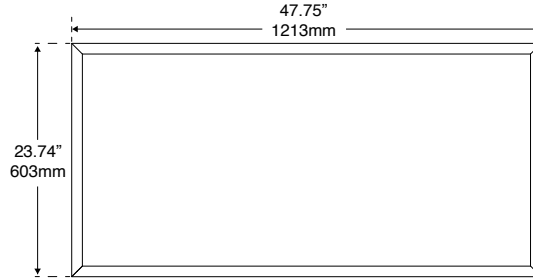

WITH J-BOX

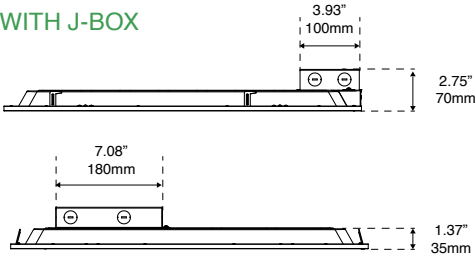

WITH J-BOX

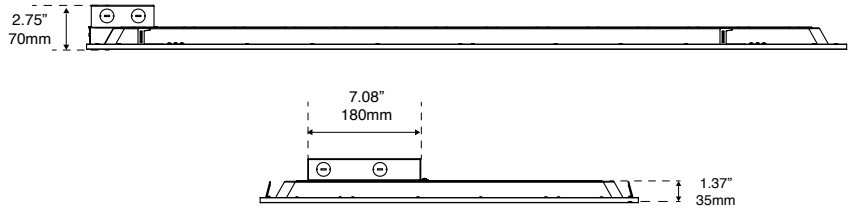

WITHOUT J-BOX



WITHOUT J-BOX

