

Please read this manual carefully before installation and keep it for future reference.

Owner's Manual



MRCOOL®

COMFORT MADE SIMPLE

Universal™ Series
DC Inverter / Condenser

Thank you for choosing MRCOOL Please read this manual carefully before installation and keep it for future reference.

! Safety Precautions 2

1 Appliance Overview 5

- 1. Introduction 5
- 2. Accessories 6
- 3. Operating Range 7
- 4. Unit Dimensions 7



2 Unit Installation 8

- 1. Installation Location..... 8
- 2. Outdoor Installation 13
- 3. Conventional Line Set Installation..... 14
- 4. No-Vac® Quick Connect® Installation ... 23
- 5. Installation of Drain Pipe..... 24
- 6. Condenser Field Conversion..... 25
- 7. Electrical Connection..... 26

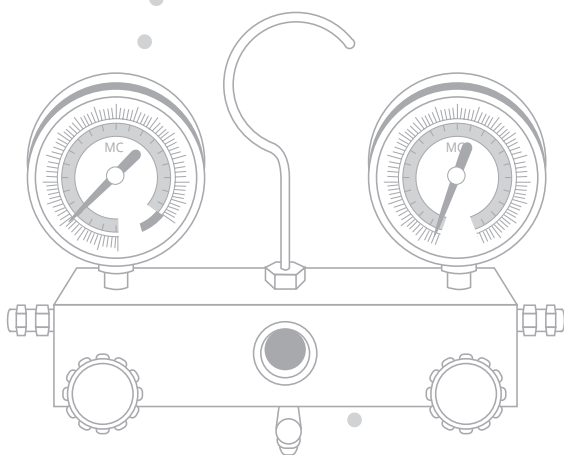

3 Post Installation Checks 31

4 Maintenance33

- 1. Troubleshooting 34
- 2. Error Codes 35
- 3. Unit Maintenance 36
- 4. Notice on Maintenance 38
- 5. After Sales Services 41

5 EU Disposal Guidelines 42

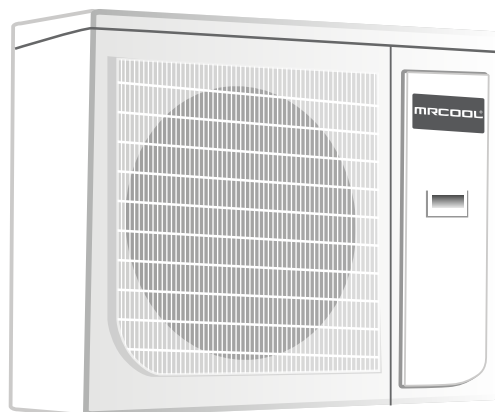

Safety Precautions



Read Before Installation

Incorrect installation may cause serious damage or injury.

The seriousness of potential damage or injuries is classified as either a **WARNING** or **CAUTION**.



WARNING

This symbol indicates ignoring instructions may cause death or serious injury.



CAUTION

This symbol indicates that ignoring instructions may cause moderate injury to your person, damage to your unit, or other property.



This symbol indicates that you should ***never*** perform the indicated action.



WARNING

Please read the manual in its entirety before installing, operating or repairing.

- ⊘ ***DO NOT*** share the electrical circuit with other appliances. Improper or insufficient power supply can cause fire or electrical shock.
 - ⊘ When connecting refrigerant piping, ***DO NOT*** let substances or gases other than the refrigerant enter the unit. The presence of other gases or substances will lower the unit's capacity, and may cause abnormally high pressure in the operation cycle. This may cause explosion and injury.
 - ⊘ ***DO NOT*** connect the ground wire to a gas pipe, water pipe, lightning arrester or telephone wire.
 - ⊘ ***DO NOT*** allow children to play with the air conditioner. Children should be supervised around the unit at all times.
 - ⊘ ***DO NOT*** alter the settings of the pressure sensor or other protective devices; if short-circuited or modified, fire or even an explosion could occur.
1. Installation must be performed by an authorized technician. Improper installation may cause water leakage, electrical shock, or fire.
 2. Installation must be performed according to installation instructions. Improper installation may cause water leakage, electrical shock, or fire.
 3. In North America, installation must be performed in accordance with the requirement of NEC and CEC (by authorized personnel only.) Contact an authorized service technician for repair or maintenance of the unit.
 4. Only use the included accessories and specified parts for installation. Using non-standard parts can cause water leakage, electrical shock, or fire and may cause the unit to fail.

WARNING

5. Install the unit in a firm location that can support the unit's weight. If the installation location cannot support the weight, or the installation is performed improperly, the unit may fall and cause serious injury and/or damage.
6. For all electrical work, follow all appropriate wiring standards, regulations, and the Installation Manual.
7. You must use an independent circuit to supply power. Do not connect other appliances to the same circuit. Insufficient electrical capacity or defects in electrical work can cause electrical shock or fire.
8. For all electrical work, fuse the specified cables. Connect cables tightly, and clamp them securely to prevent external forces from damaging the terminal. Improper electrical connections may overheat, causing fire and/or electrical shock.
9. All wiring must be properly arranged to ensure that the control board cover can close properly. If the control board cover is not closed properly, it can lead to corrosion and cause the connection points on the terminal to overheat, causing fire and/or electrical shock.
10. In certain functional environments, such as kitchens, server rooms, etc., the use of specially designed air-conditioning units is highly recommended. If the supply cord is damaged, it must be replaced by the manufacturer, its service agent or similarly qualified persons in order to avoid a hazard.
11. This appliance can be used by children aged 8 years and above and persons with reduced physical, sensory or mental capabilities or lack of experience and knowledge if they have been given supervision or instruction concerning use of the appliance in a safe way and understand the hazards involved. Children should not play with the appliance. Cleaning and user maintenance should not be made by children without supervision.
12. The air conditioner unit can only be cleaned after it has been turned off and disconnected from power, otherwise electric shock may occur.
13. If installed in a compact space, ensure that there is adequate ventilation in case of leakage. Concentration of refrigerant gas can lead to explosion and other hazards.
14. The fixed wires connecting to this appliance must be configured with an all-pole disconnect under voltage class III.

Note about Flourinated Gasses:

1. This air-conditioning unit contains R410A flourinated gases.
2. The refrigerant gas may not have an odor, thus this should not be considered a means of leak detection.
3. Installation, service, maintenance and repair of this unit must be performed by a certified technician.
4. Product uninstallation and recycling must be performed by a certified technician.
5. If the system has a leak-detection system installed, it should be checked for leaks at least every 12 months.
6. Keep a record of all leak checks for the lifetime of the unit.

CAUTION

- ⑦ For units that have an auxiliary electric heater, ***DO NOT*** install the unit within 3 feet (1 meter) of combustible materials.
- ⑦ ***DO NOT*** install the unit in a location that may be exposed to combustible gases. If combustible gas accumulates around the unit, it may cause fire.
- ⑦ ***DO NOT*** operate your air conditioner in a wet room such as a bathroom or laundry room. Too much exposure to water may cause electrical components to short circuit.
- ⑦ ***DO NOT*** put appendages or other objects into the air inlet or return grills.
- ⑦ ***DO NOT*** stop the appliance by directly cutting off the power. Turn off the unit first.
- ⑦ ***DO NOT*** install the appliance in areas with -
 - oil smoke or volatile liquid, as plastic parts may deteriorate, adversely affecting the integrity and functionality of the appliance.
 - or corrosive gas; as this may corrode copper piping and welds, adversely affecting the integrity and functionality of the appliance.
- ⑦ ***DO NOT*** force-dry the filter using open flame or blowers, as this could damage it.
 1. This appliance must be properly grounded during installation, or electrical shock may occur.
 2. Install drainage piping according to the instructions in this manual. Improper drainage may cause water damage to your home and property.
 3. This appliance must be stored in a well ventilated area equal in size to the area specified for operation.
 4. Use proper measures to protect the outdoor unit from rodents and other small animals that may damage electrical components, causing the unit to malfunction.
 5. If wired control (i.e. a wall-mount thermostat) is to be used, it should be connected first before powering up the unit, otherwise it may not function properly.
 6. Only use a soft dry cloth or, as necessary, a slightly wet cloth with neutral detergent to clean the casing of this appliance.
 7. Before operating the unit under low temperature, connect it to power for 8 hours. If it is deactivated for a short time, for example, one night, do not cut off the power (this is to protect the compressor).

To Our Customers;

Thank you for choosing a MRCOOL home HVAC product. Please read this manual carefully before installation and operation of the Universal™ Series Central HVAC System to ensure correct use and handling. In addition to the safety precautions in the previous section, please adhere to the following guidelines and note our exceptions to liability.

- 1.** This appliance can be used by children aged 8 years and above and persons with reduced physical, sensory or mental capabilities or lack of experience and knowledge if they have been given supervision or instruction concerning use of the appliance in a safe way and understand the hazards involved. Children should not play with the appliance. Cleaning and user maintenance should not be made by children without supervision.
- 2.** To ensure product reliability, the unit may consume power under stand-by status to maintain normal communication, and for preheating refrigerant and lubricant. If the unit will not be used for an extended period, disconnect the power supply. Reconnect the power supply and preheat the unit prior to use.
- 3.** Ensure you have selected the proper model for the operating environment. Improper selection may impact operating performance.
- 4.** This product has undergone strict inspection and operational testing before leaving the factory. To avoid damage due to improper disassembly, which may impact the normal operation, please do not disassemble the unit without proper training and equipment.
- 5.** For technical assistance, please contact MRCOOL technical support at (270) 366-0457.
- 6.** When the product is malfunctioning and/or is inoperable, please contact MRCOOL technical support at the fore mentioned number, as soon as possible and provide the following information:
 - a.** Product Nameplate Contents (model number, cooling / heating capacity, product serial number, factory date)
 - b.** Nature of Malfunction (specify the circumstances before and after the error occurred)
- 7.** All illustrations and information in the instruction manual are for reference only. In order to improve the product , we will continuously assess and innovate. We retain the right to make necessary revisions to the product from time to time. We reserve the right to revise the contents of this manual without notice.
- 8.** If the supply cord is damaged, it must be replaced by MRCOOL, a professional service agent or similarly qualified person in order to avoid damage to the product.
- 9.** MRCOOL, LLC assumes no responsibility for personal injury, property loss or equipment damage caused by improper installation and commissioning, unnecessary maintenance, or failure to follow relevant federal and state regulations, industrial standards, and the requirements of this instruction manual.
- 10.** MRCOOL, LLC will bear no responsibilities for personal injury or property damage caused by the following:
 - a.** Improper use of the appliance
 - b.** Altering, maintaining, or operating the product with non-approved equipment.
 - c.** Altering, maintaining, or operating the product outside of the guidelines of this manual.
 - d.** Defects caused by corrosive gas.
 - e.** Defects caused by shipping damage.
 - f.** Failure to abide by this instruction manual or government regulations.
 - g.** Products made by other manufacturers
 - h.** Natural disasters, improper installation environment, or force majeure.

Appliance Overview

Unless otherwise stated (as "OPTIONAL") the air conditioning system includes the following accessories. Use all of the installation parts and accessories to install the air conditioner. Improper installation may result in water leakage, electrical shock, fire, or equipment failure.



| PART | LOOKS LIKE... | QUANTITY |
|---|--|---------------------|
| Owner's Manual |  | 1 (this) |
| Drain Plug |  | 1 |
| Drainage Connector |  | 1 |
| OPTIONAL No-Vac® Quick Connect® Lineset Gas / Liquid Pipe Assembly |  | 1 |

Fig. 1.1

Appliance Overview

| Operating Range | COOLING | HEATING |
|---------------------|-----------------------------|----------------------------|
| Outdoor Temperature | 5°F(-15°C) ~ 125.6°F (52°C) | -22°F(-30°C) ~ 86°F (30°C) |

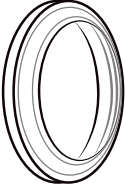
Unit Dimensions

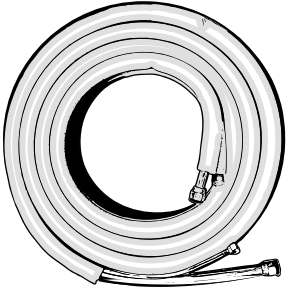
MDUO18024036

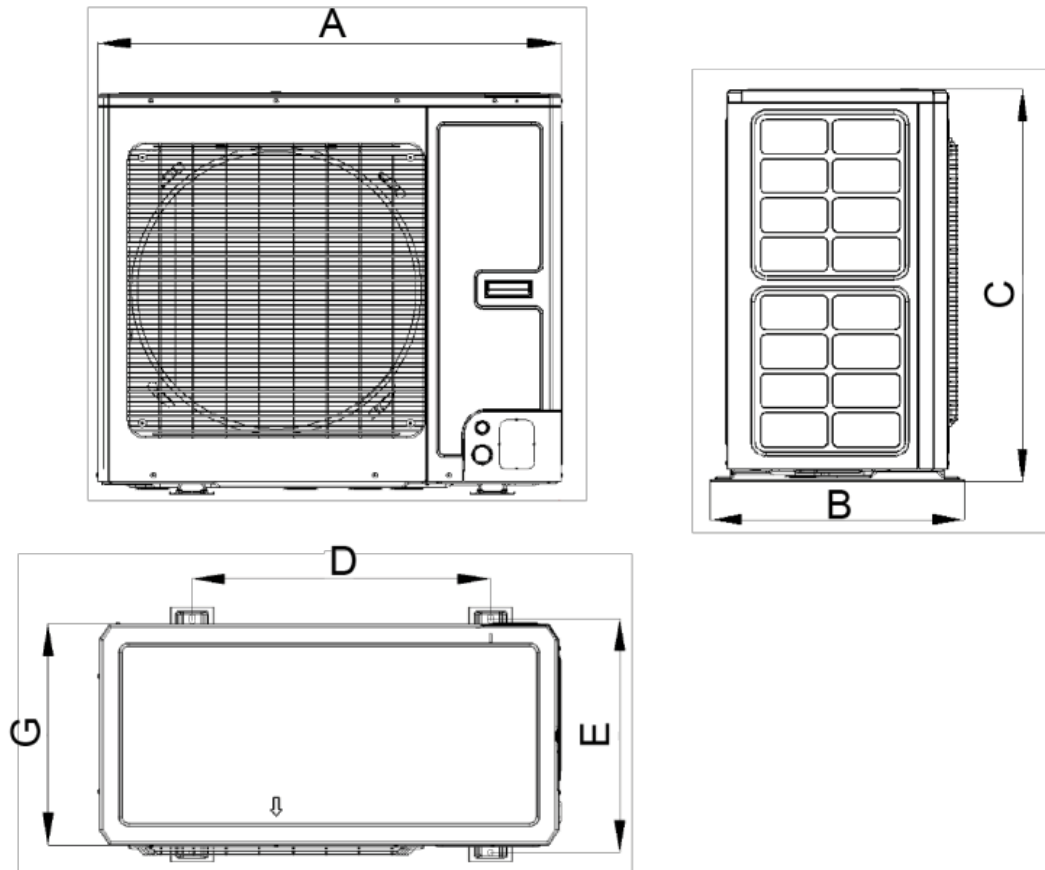

Fig. 1.2

| | Outdoor Unit Dimensions | | Mounting Dimensions | |
|--------------|---|------------------------|-----------------------------|-------------------------------------|
| | Width (A) | Height (C) x Depth (G) | Width (A / D) | Depth (B / E) |
| MDUO18024036 | 37 x 32.25 x 18.125 in. 940 x 820 x 460 mm | | 37 / 24 in. 940 / 610 mm | 20.875 / 19.125 in. 530 / 486 mm |

The Universal™ Series has 2 installation methods

1. The Conventional Weld Line Set Installation

Instructions can be found on **pages 14 through 21**
OR
View complete install video by scanning this QR code



2. No-Vac® Quick Connect® Line Set Installation

Instructions can be found on **page 22**
OR
View complete install video by scanning this QR code



MRCOOL®
Preferred Method

Installation Location



WARNING

1. The unit must be installed in a location strong enough to support the weight of the unit and fixed securely, to avoid toppling.
2. Install the appliance in a location where the inclination is less than 5°.
3. Do not install the unit in a location with direct sunlight.
4. Do not install the unit where combustible gas leakage may occur.

1. Selection of Installation Location for Outdoor Unit
2. Select a location pursuant to the following conditions:
3. Noise and air flow produced by the outdoor unit will not disturb neighbors.
4. The location is away from animals and plants. If not, please add safety fences to protect the unit.
5. The area is well-ventilated with no nearby obstacles that could obstruct air flow.
6. The location is able to support the weight and withstand the operating vibration of the unit.
7. Installation is able to be performed safely.
8. The location area is free of combustible or corrosive gas, and oil smoke.
9. Unit is able to be shielded from strong wind. Strong wind may affect the outdoor fan and lead to insufficient air flow volume, thus affecting performance.
10. Unit is away from objects which can generate or amplify noise during operation.
11. Condensate can be safely drained from the unit.

Unit Installation

Installation Location

For best performance of the outdoor unit, make sure its installation space conforms to the following installation dimensions...

For installation of a single condenser refer to fig 2.1 below:

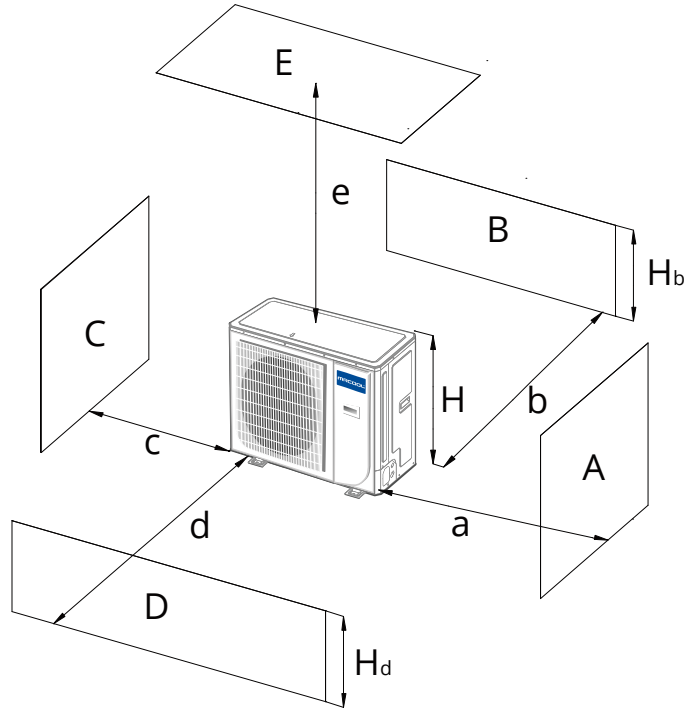

Fig. 2.1

| A ~ E | H _b | H _d | H | inches (") millimeters (mm) | | | | | |
|---------|---------------------------------|---------------------------|-------------------|-----------------------------|------------------|------------------|--------------------|--------------------|--------------------|
| | | | | a | b | c | d | e | |
| B | | — | | | ≥ 3.94" 100mm | | | | |
| A,B,C, | | — | | ≥ 11.81" 300mm | ≥ 3.94" 100mm | ≥ 3.94" 100mm | | | |
| B,E | | — | | | ≥ 3.94" 100mm | | | ≥ 39.37" 1000mm | |
| A,B,C,E | | — | | ≥ 11.81" 300mm | ≥ 5.9" 150mm | ≥ 5.9" 150mm | | ≥ 39.37" 1000mm | |
| D | | — | | | | | ≥ 39.37" 1000mm | | |
| D,E | | — | | | | | ≥ 39.37" 1000mm | ≥ 39.37" 1000mm | |
| B,D | H _b < H _d | H _d > H | | | ≥ 3.94" 100mm | | ≥ 39.37" 1000mm | | |
| | H _b > H _d | H _d < H | | | ≥ 3.94" 100mm | | ≥ 39.37" 1000mm | | |
| B,D,E | H _b < H _d | H _b ≤ 1/2H | | | ≥ 9.84" 250mm | | ≥ 78.74" 2000mm | ≥ 39.37" 1000mm | |
| | | 1/2H < H _b ≤ H | | | ≥ 9.84" 250mm | | ≥ 78.74" 2000mm | ≥ 39.37" 1000mm | |
| | | H _b > H | Prohibited | | | | | | |
| | H _b > H _d | H _d ≤ 1/2H | | | | ≥ 3.94" 100mm | | ≥ 78.74" 2000mm | ≥ 39.37" 1000mm |
| | | 1/2H < H _d ≤ H | | | | ≥ 7.87" 200mm | | ≥ 78.74" 2000mm | ≥ 39.37" 1000mm |
| | | H _d > H | Prohibited | | | | | | |

Unit Installation

Installation Location

For best performance of the outdoor unit, make sure its installation space conforms to the following installation dimensions...

For installation of multiple condensers side by side refer to fig 2.2 below:

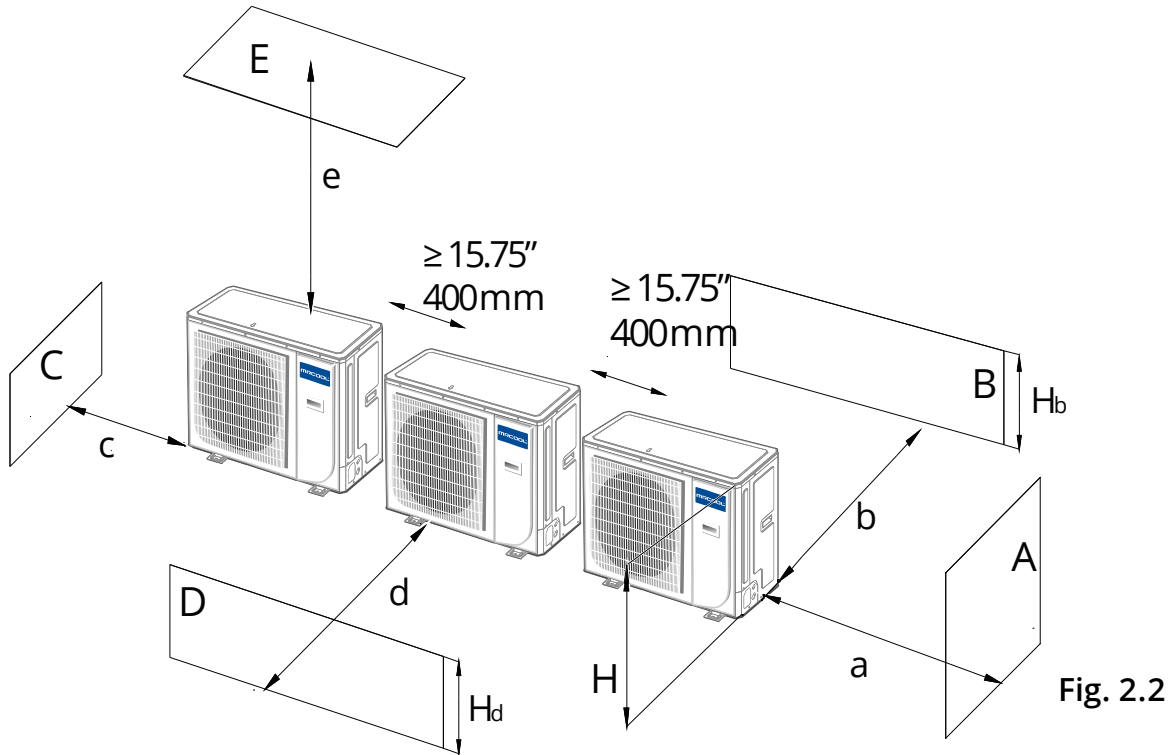

Fig. 2.2

| A ~ E | H _b | H _d | H | inches (") millimeters (mm) | | | | | |
|---------|---------------------------------|---------------------------|-------------------|-----------------------------|-------------------------|--------------------------|--------------------------|--------------------------|--------------------------|
| | | | | a | b | c | d | e | |
| A,B,C, | | — | | $\geq 11.81''$ 300mm | $\geq 11.81''$ 300mm | $\geq 39.37''$ 1000mm | | | |
| A,B,C,E | | — | | $\geq 11.81''$ 300mm | $\geq 11.81''$ 300mm | $\geq 39.37''$ 1000mm | | $\geq 39.37''$ 1000mm | |
| D | | — | | | | | $\geq 78.74''$ 2000mm | | |
| D,E | | — | | | | | $\geq 78.74''$ 2000mm | $\geq 39.37''$ 1000mm | |
| B,D | H _b < H _d | H _d > H | | | $\geq 11.81''$ 300mm | | $\geq 78.74''$ 2000mm | | |
| | H _b > H _d | H _d ≤ 1/2H | | | $\geq 9.84''$ 250mm | | $\geq 78.74''$ 2000mm | | |
| | | H _d < H | | | $\geq 11.81''$ 300mm | | $\geq 98.43''$ 2500mm | | |
| B,D,E | H _b < H _d | H _b ≤ 1/2H | | | $\geq 11.81''$ 300mm | | $\geq 78.74''$ 2000mm | $\geq 39.37''$ 1000mm | |
| | | 1/2H < H _b ≤ H | | | $\geq 11.81''$ 300mm | | $\geq 98.43''$ 2500mm | $\geq 39.37''$ 1000mm | |
| | | H _b > H | Prohibited | | | | | | |
| | H _b > H _d | H _d ≤ 1/2H | | | | $\geq 9.84''$ 250mm | | $\geq 98.43''$ 2500mm | $\geq 39.37''$ 1000mm |
| | | 1/2H < H _d ≤ H | | | | $\geq 11.81''$ 300mm | | $\geq 98.43''$ 2500mm | $\geq 39.37''$ 1000mm |
| | | H _d > H | Prohibited | | | | | | |

Unit Installation

Installation Location

For best performance of the outdoor unit, make sure its installation space conforms to the following installation dimensions...

For installation of multiple condensers in rows refer to fig 2.3 below:

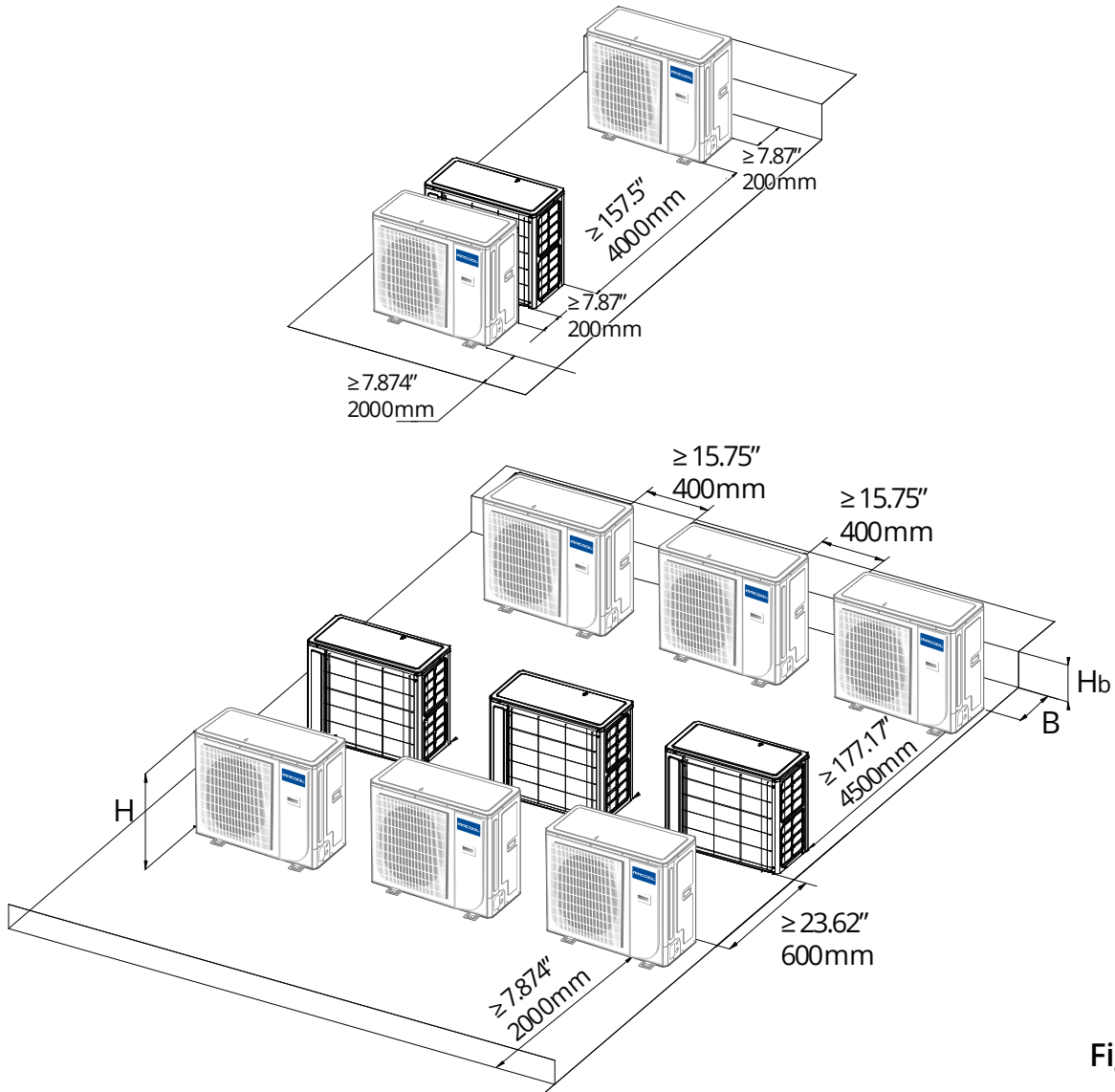

Fig. 2.3

| H_b H | inches (") millimeters (mm) |
|---------------------|-----------------------------|
| $H_b \leq 1/2H$ | $B \geq 9.84''$ 250mm |
| $1/2H < H_b \leq H$ | $B \geq 11.81''$ 300mm |
| $H_b > H$ | Prohibited |

Installation Location

For best performance of the outdoor unit, make sure its installation space conforms to the following installation dimensions...

For installation of multiple condensers on a vertical face refer to fig 2.4 below:

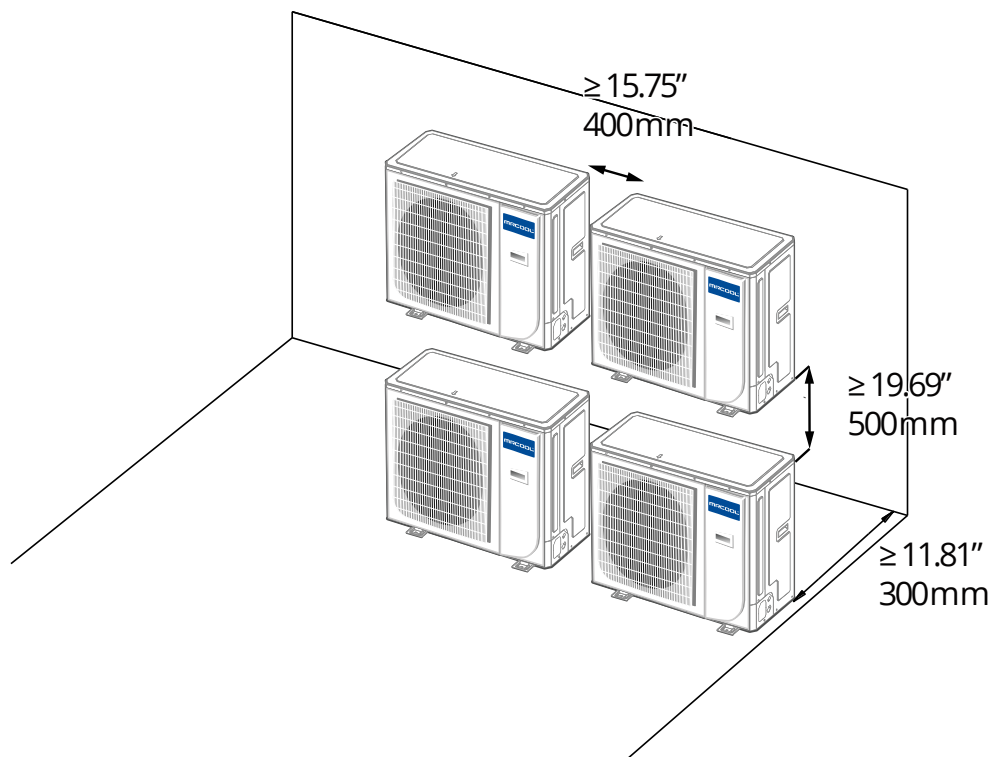
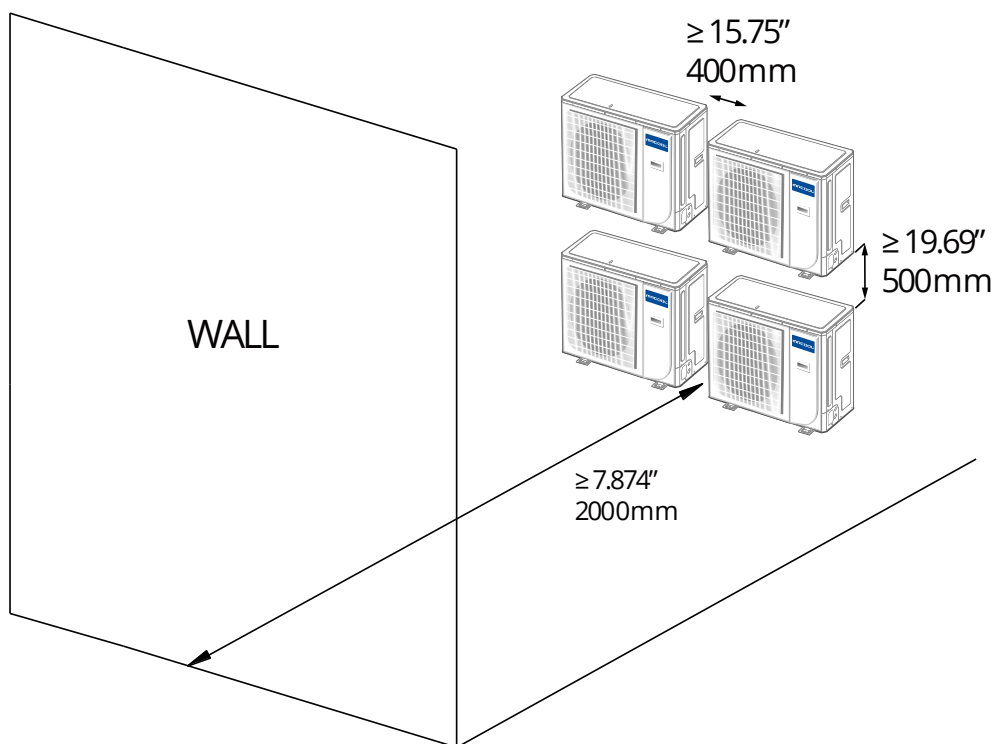

Fig. 2.4

Outdoor Unit Installation

1. If the outdoor unit is installed on a solid surface such as concrete, use M10 screw bolts and nuts to secure the unit. Make sure the unit stands erect and level.
2. Do not install it on top of a building.
3. If the unit vibrates and generates noise, add rubber cushions between the unit's feet and the installation surface.
4. When the outdoor unit is in heating or defrosting mode, it must drain water. When installing the drain pipe, plug the accompanied drainage connector to the drainage hole on the chassis of the outdoor unit. Then, connect the drain hose to the drainage connector. If the drainage connector is used, the outdoor unit should be at least 10cm from the ground.
5. Plugs and drainage connector are not recommended if there is an electrical heater of the chassis.

Refer to **Fig. 2.5** for details.

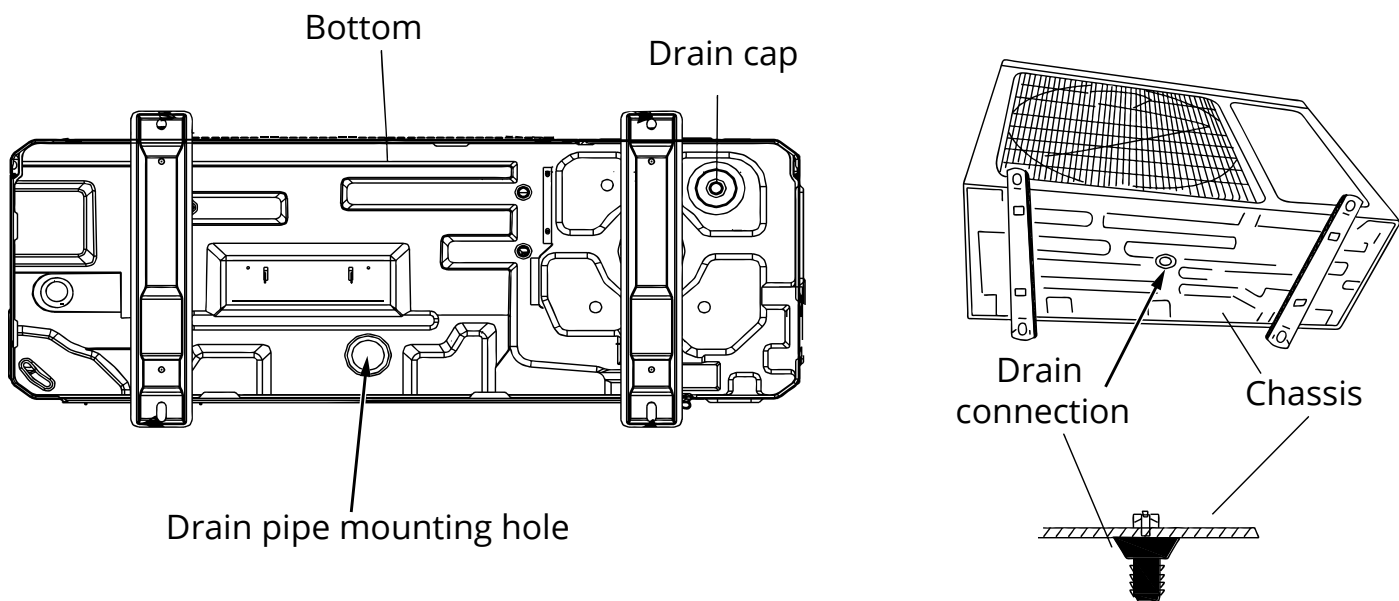

Fig. 2.5

Unit Installation

Conventional Line Set Installation

INSTALLATION METHOD

Connect the refrigerant lines to the unit first. When bending a refrigerant pipe, be careful not to kink or crimp the pipe. Do not over-tighten the screw nut, otherwise leakage may occur. The outside of the refrigerant pipe should have a layer of insulating cotton to protect it from mechanical damage during installation, maintenance and transportation.

Refrigerant lines should adopt water-proof insulating material. The pipe wall thickness should be 0.5-1.0mm and able to withstand 6.0MPa. Excessive length of the refrigerant lines will negatively affect cooling and heating performance. Attempt to minimize refrigerant line length when possible.

When the drop between indoor and outdoor units is larger than 32 feet (10 meters), an oil return bend should be added every 19.69 feet (6 meters).

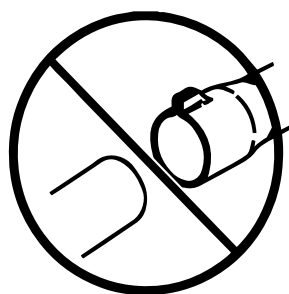
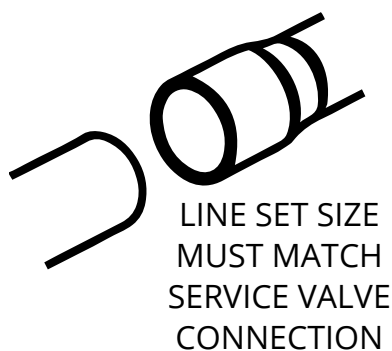

DO NOT CRIMP SERVICE VALVE
CONNECTOR IF PIPE IS
SMALLER THAN CONNECTION

| Outdoor Unit Model | Size of Fitting Pipe | | Maximum Pipe Length | Maximum Drop between indoor and outdoor units |
|--------------------|----------------------|------------|------------------------|---|
| | Liquid Pipe | Gas Pipe | | |
| MDUO18024036 | 3 / 8 inch | 3 / 4 inch | 164 feet 50 m | 49.2 feet 15 m |

CAUTION

Be extremely careful not to dent or damage the piping while bending them away from the unit. Any dents in the piping will affect the unit's performance.

For installation with a **No-Vac® Quick Connect® Line Set**, refer to the next section starting on page 22

Unit Installation

OIL RETURN BENDS

Add an oil return bend as described below:

IF Outdoor unit is beneath the indoor unit, there is no need to add a non-return bend at the lowest or highest position of the vertical pipe, as shown below in **Fig. 2.6**:

IF Outdoor unit is above the indoor unit, it is necessary to add an oil return bend and a non-return bend at the lowest and highest position of the vertical pipe, as shown below in **Fig. 2.7**:

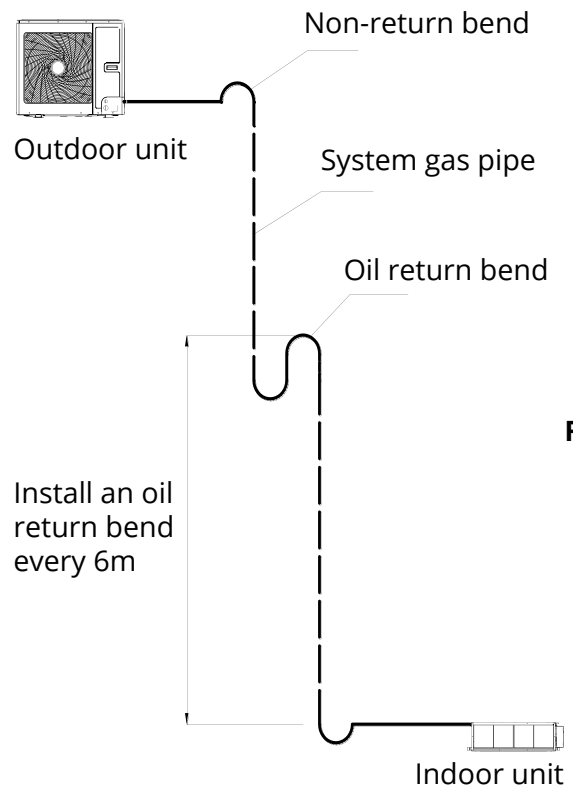
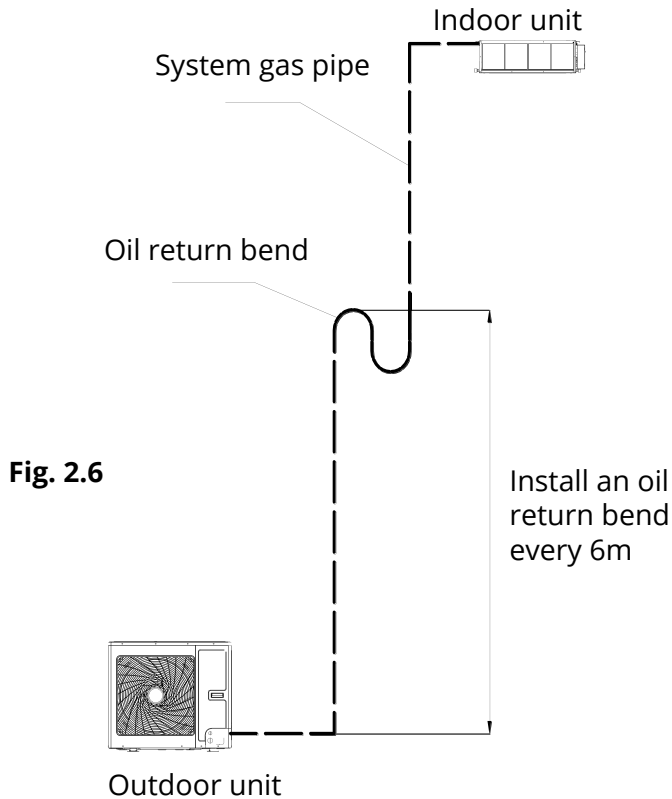

Use the following dimensions in **Fig. 2.8** to form the oil return bend(s):

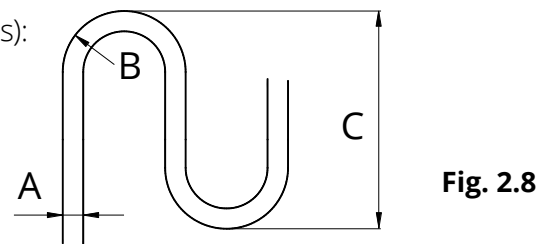

| A | | B | | C | |
|--------|------|--------|-----|--------|------|
| Inches | mm | Inches | mm | Inches | mm |
| Φ12 | Φ1/2 | ≥1 | ≥26 | ≥5.91 | ≤150 |
| Φ16 | Φ5/8 | ≥1.3 | ≥33 | ≥5.91 | ≤150 |
| Φ19 | Φ3/4 | ≥1.34 | ≥34 | ≥5.91 | ≤150 |

For installation with a **No-Vac® Quick Connect® Line Set**, refer to the next section starting on page 22

Conventional Line Set Installation

Pipe Cutting

Step 1: Cut Pipe

1. When preparing refrigerant pipes, take extra care to cut and flare them properly. This will ensure efficient operation and minimize the need for future maintenance.
2. Measure the distance between the indoor and outdoor units.
3. Using a pipe cutter, cut the pipe a little longer than the measured distance.
4. Make sure that the pipe is cut at a perfect 90° angle. Refer to **Fig. 2.9** for cut examples.

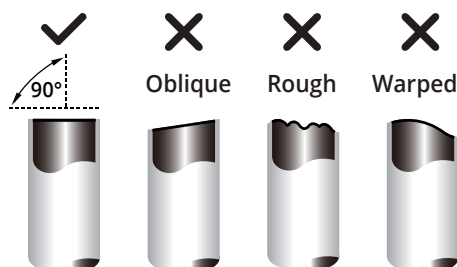

Fig. 2.9

! DO NOT DEFORM PIPE WHILE CUTTING

Be extra careful not to damage, dent, or deform the pipe while cutting. This will drastically reduce the heating efficiency of the unit.

Step 2: Remove burrs

Burrs can affect the air-tight seal of refrigerant piping connection. They must be completely removed.

1. Hold the pipe at a downward angle to prevent burrs from falling into the pipe.
2. Using a reamer or deburring tool, remove all burrs from the cut section of the pipe. Refer to **Fig. 2.10**
3. After removing burrs from cut pipe, seal the ends with PVC tape to prevent foreign materials from entering the pipe.

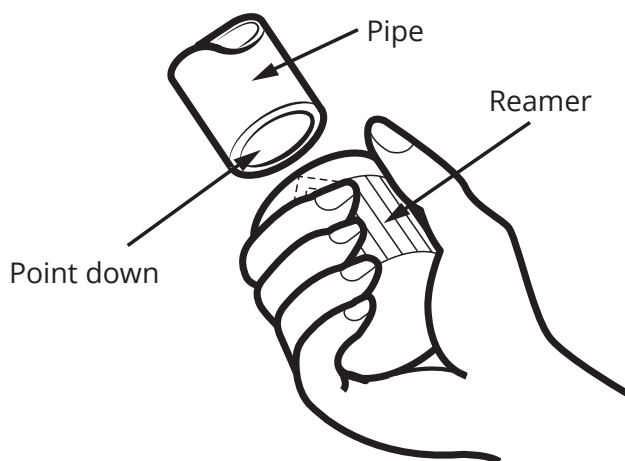

Fig. 2.10

For installation with a **No-Vac® Quick Connect® Line Set**, refer to the next section starting on page 22

Conventional Line Set Installation

Pipe Flaring

Step 3: Flare pipe ends

Proper flaring is essential to achieve an airtight seal.

1. After removing burrs from cut pipe, seal the ends with PVC tape to prevent foreign materials from entering the pipe.
2. Sheath the pipe with insulating material as necessary
3. Remove the cut-off valve of outdoor unit and take out the flare nut from the bag of indoor unit accessories. Fit the flare nut on the pipe - see **Fig. 2.11**.
4. Make sure it is facing in the right direction, because you can not remove the nut or change its direction after flaring. See **Fig. 2.12**.
5. Remove PVC tape from ends of pipe when ready to perform flaring work.
6. Clamp flare form on the end of the pipe. The end of the pipe should extend $\sim 1/16''$ (1.6mm) beyond the edge of the flare form as shown in **Fig. 2.13**
7. Place flaring tool onto the form as shown in **Fig. 2.14**
8. Turn the handle of the flaring tool clockwise until the pipe is fully flared.
9. Remove the flaring tool and flare form, then inspect the end of the pipe for cracks and even flaring.

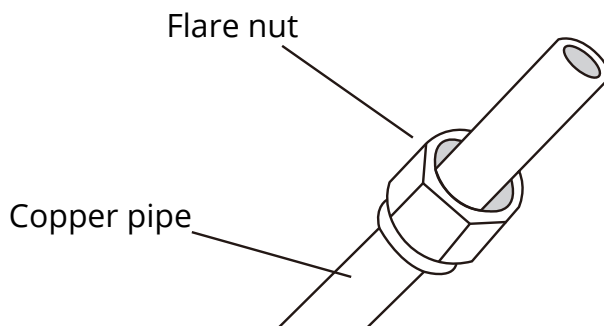

Fig. 2.11

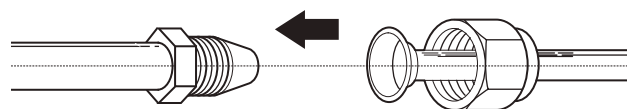

Fig. 2.12

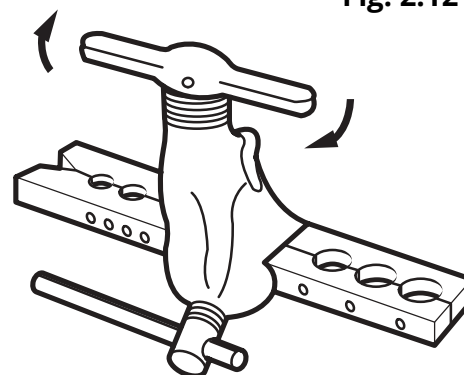

Fig. 2.13

PIPING EXTENSION BEYOND FLARE FORM

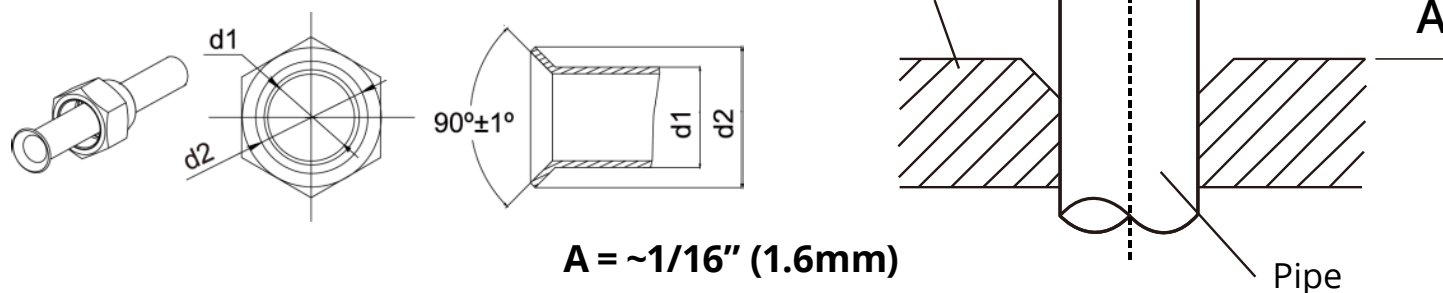

Fig. 2.14

For installation with a **No-Vac® Quick Connect® Line Set**, refer to the next section starting on page 22

Conventional Line Set Installation

Replacement Condenser Only

Fig. 2.15

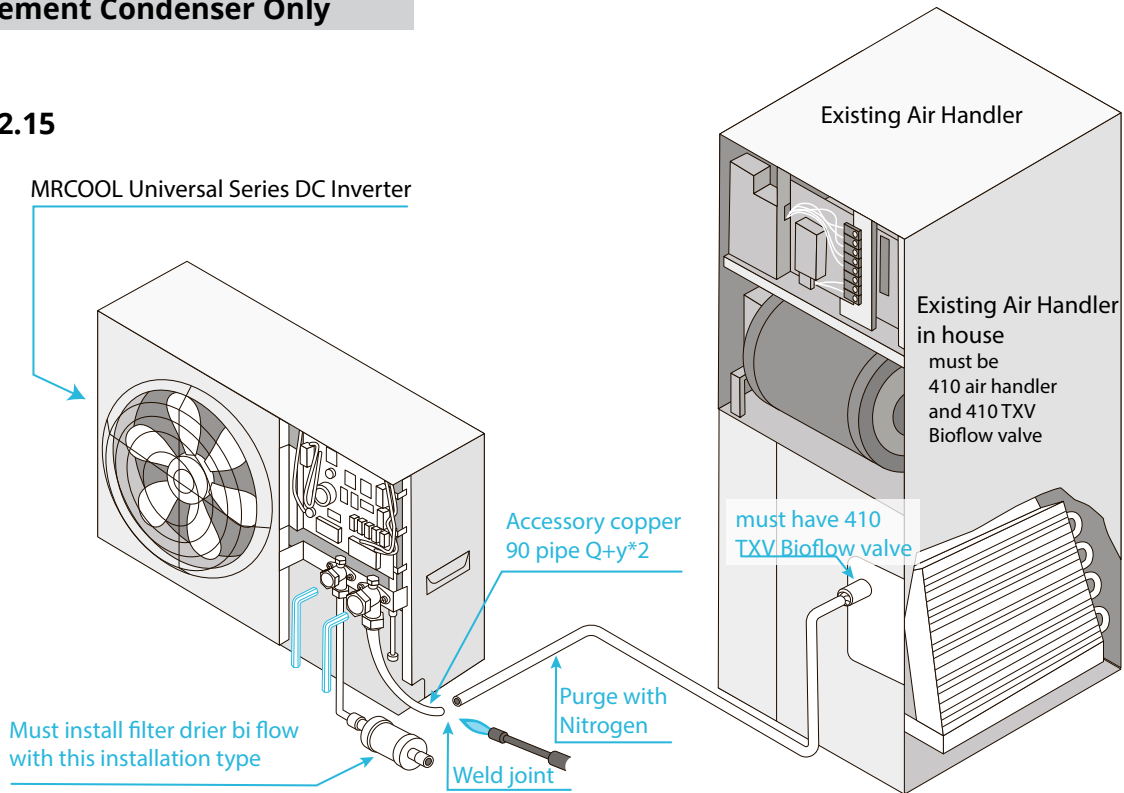

WELD Type Complete Unit Replacement

Fig. 2.16

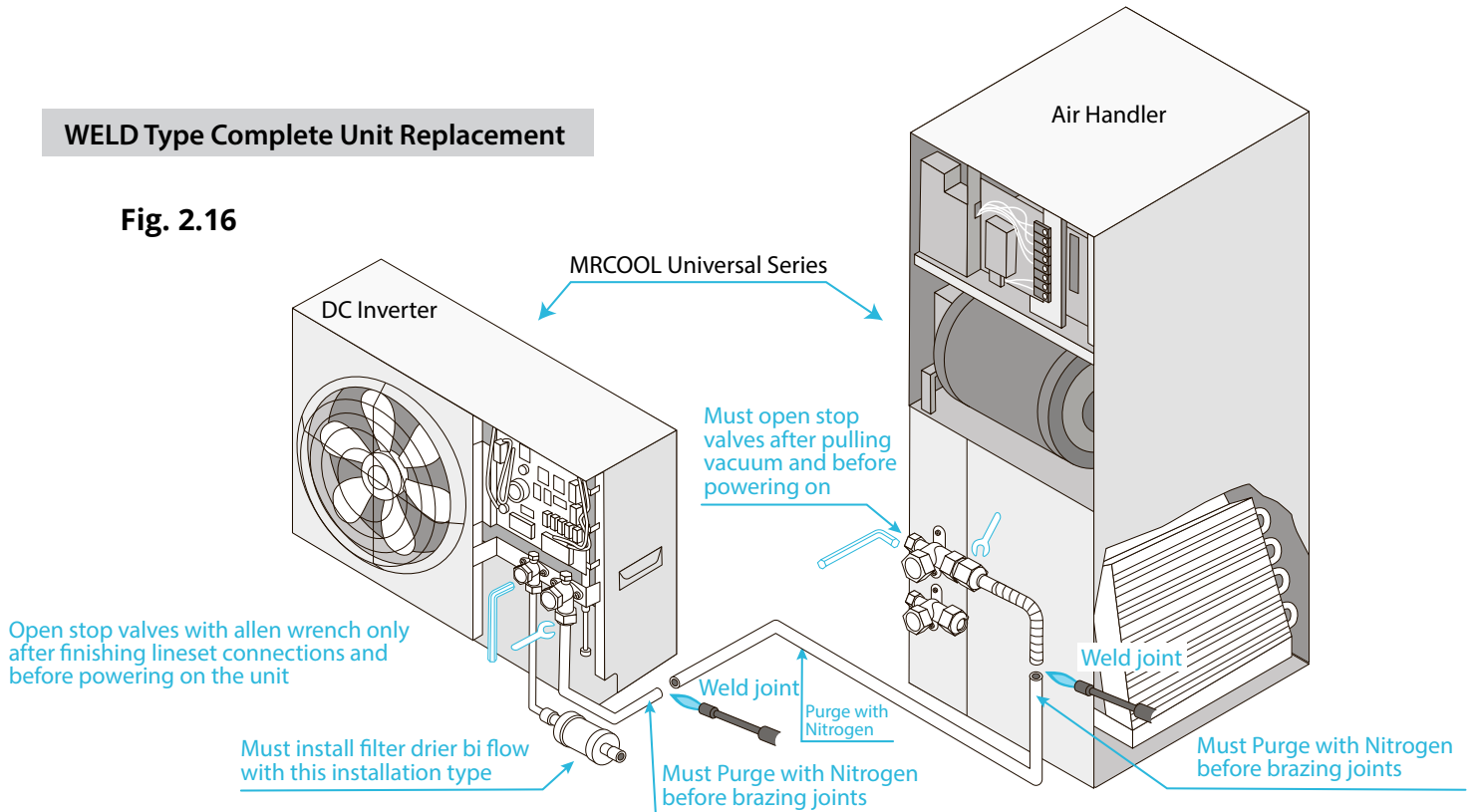

Conventional Line Set Installation

Pipe Bending

1. Use your hands to bend the pipes. Work carefully to collapse them.
2. Do not bend the pipes in at an angle greater than 90°.
3. If the pipe is repeatedly bent or extended, it will become hard and difficult to manipulate. Avoid bending or extending the pipe for more than 3 times.
4. Do not bend the pipe excessively, otherwise it will break.

Refer to **Fig. 2.17**

MINIMUM BEND RADIUS

When bending connective refrigerant piping, the minimum bending radius is a10cm. Refer to **Fig. 2.17**

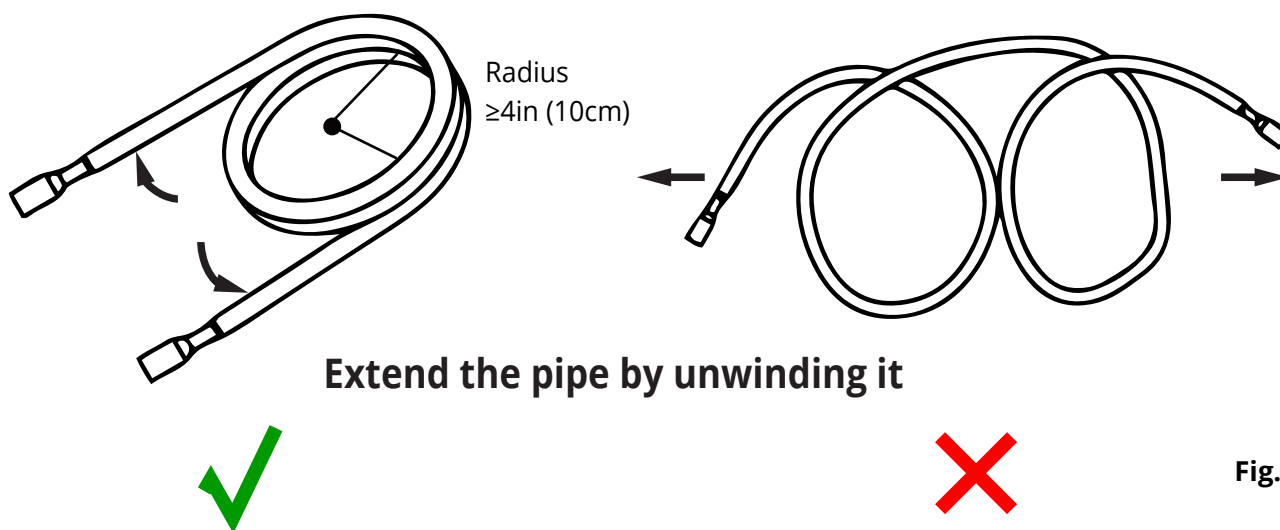

5. As shown in **Fig. 2.18**, use a sharp cutter to cut the pipe insulation and bend the pipe after it is exposed. After bending, place the insulation back on the pipe and secure it with adhesive tape.

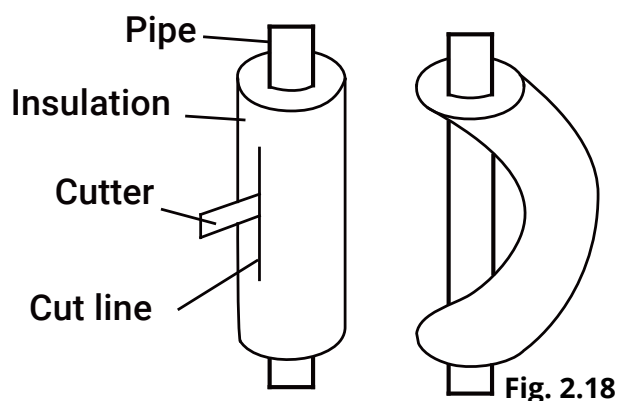

For installation with a **No-Vac® Quick Connect® Line Set**, refer to the next section starting on page 22

Conventional Line Set Installation

Pipe Connection



WARNING

1. Connect the pipe to the unit. Follow all instructions below. Use both spanner and torque wrench.
2. When connecting the tapered screw nut, first apply chilled machine oil on its inner and outer surface and then screw it on 3 or 4 threads.
3. Confirm the tightening torque by referring to the following table. If the screw nut is over-twisted, it may be damaged and cause leakage.
4. Check whether gas leakage is occurring and then apply thermal insulation.
5. Wind sponge around the joint of gas pipe and heat insulation sheath of gas collecting pipe.
6. Be sure to connect gas pipe after liquid pipe is connected.
7. Keep pipe connection joint exposed to perform the leak test (refer to **Post Installation Checks** section of this manual).

1. Screw on the flare nut of the flared connecting pipe onto the outdoor unit valve. Refer to **Fig. 2.19** & **Fig. 2.20**, using the torque values in the table below.

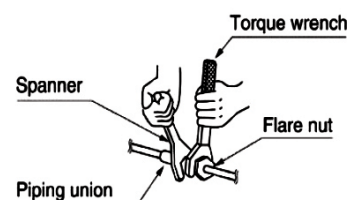
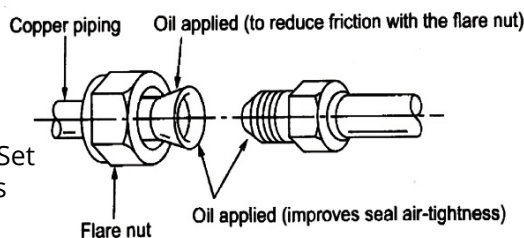
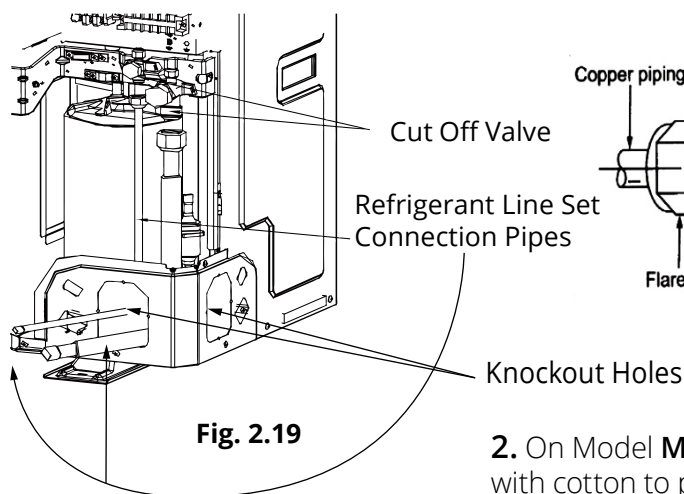

Fig. 2.20

2. On Model **MDUO18024036** plug the knockout holes shown in **Fig. 2.19** with cotton to prevent small animals and debris from entering the unit.

| Pipe diameter (in. mm) | Tightening torque (N·m) |
|--------------------------|-------------------------|
| Φ1/4" Φ6.4 | 15-30 |
| Φ3/8" Φ8.3 | 35-40 |
| Φ1/2" Φ12.7 | 45-50 |
| Φ5/8" Φ15.9 | 60-65 |
| Φ3/4" Φ19 | 70-75 |
| Φ7/8" Φ22.2 | 80-85 |



DO NOT USE EXCESSIVE TORQUE

Excessive force can break the nut or damage the refrigerant piping. You must not exceed torque requirements shown in the table.

For installation with a **No-Vac® Quick Connect® Line Set**, refer to the next section starting on page 22

Conventional Line Set Installation

Vacuum Lines



WARNING

Make sure the outlet of the vacuum pump is away from any potential source of fire and is well-ventilated.

1. Remove the caps on the liquid valve, gas valve and also the service port.
2. Connect the hose at the low pressure side of the manifold valve assembly to the service port of the unit's gas valve. Meanwhile, the gas and liquid valves should be kept closed to avoid refrigerant leak.
3. Connect the hose used for evacuation hose to the vacuum pump.
4. Open the switch on the lower pressure side of the manifold valve assembly and start the vacuum pump. The switch at the high pressure side of the manifold valve assembly should be kept closed. If not, evacuation would fail.
5. The evacuation duration typically depends on unit capacity. **for Model MDUO18024036 time is generally 30 minutes.** Verify if that the pressure gauge on the low pressure side of the manifold valve assembly reads -0.1Mp (-75cmHg). If it does not, there is leak somewhere. Close the switch fully and stop the vacuum pump.
6. Wait for 10min to see if the system pressure remains unchanged. During this time, the reading of the pressure gauge at the low pressure side should not be larger than 0.005Mp (0.38cmHg).
7. Open the liquid valve slightly, and let some refrigerant go to the connection pipe to balance the pressure inside and outside of the connection pipe, so that air will not come into the connection pipe when removing the hose. Note that the gas and liquid valve can be opened fully only after the manifold valve assembly is removed.
8. Return the caps to the liquid valve, gas valve and service port.
9. **For large-size units,** there are maintenance ports for liquid valve and gas valve. During evacuation, you may connect the two hoses of the branch valve assembly to the maintenance ports to speed up the evacuation.

Refer to **Fig. 2.20**

For installation with a **No-Vac® Quick Connect® Line Set**, refer to the next section starting on page 22

Unit Installation

Conventional Line Set Installation

Vacuum Lines

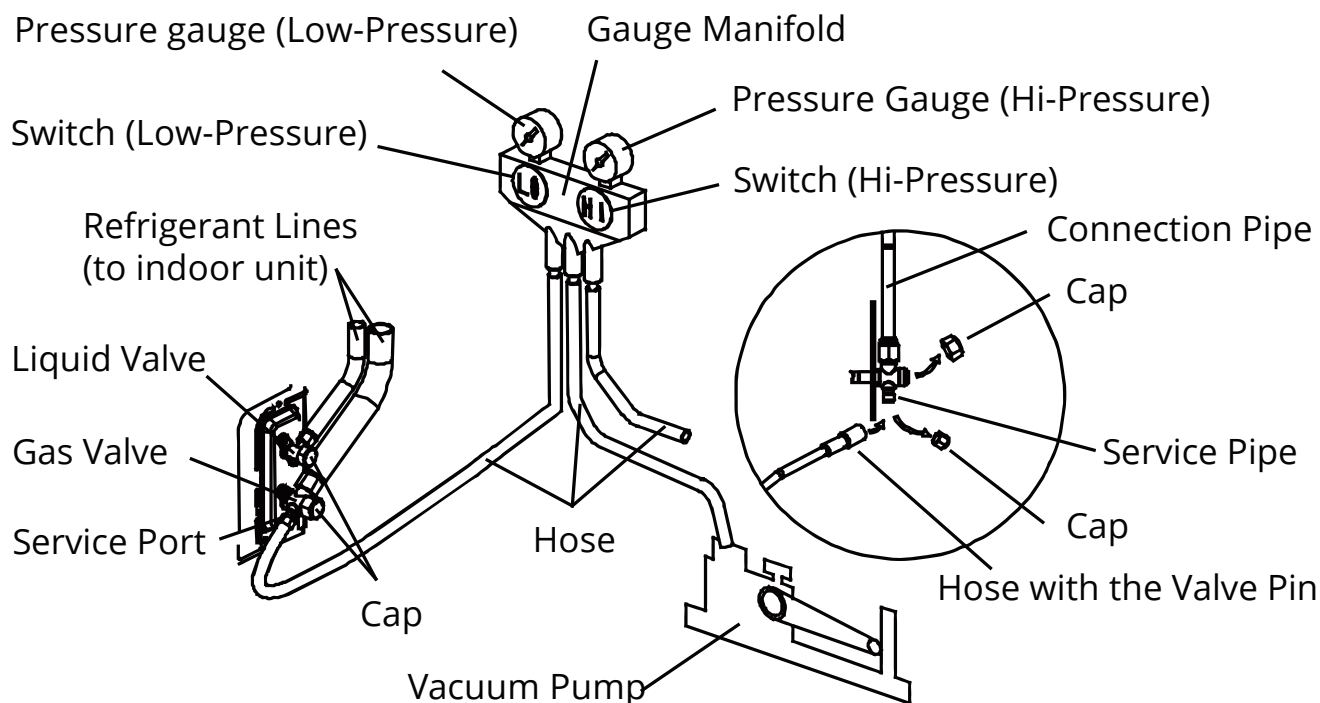

Fig. 2.20

Adding Refrigerant

| Outdoor Unit Model | Standard Pipe Length | Max Pipe Length Requiring No Added Charge | Additional Refrigerant per Line Length |
|--------------------|----------------------|---|--|
| MDUO18024036 | 24.6 feet 7.5m | ≤31.2 feet ≤9.5m | 0.58 oz/ft 54 g/m |

For installation with a **No-Vac® Quick Connect® Line Set**, refer to the next section starting on page 22

No-Vac® Quick Connect® Line Set Installation

**INSTRUCTIONS FOR USE WITH NO-VAC™ QUICK CONNECT® LINE SET SOLD SEPARATELY
KINK RESISTANT, PRECHARGED, SIMPLE SECURE QUICK CONNECT, 100% CONNECTION GUARANTEE**

Please read and follow the instructions and diagram below¹:

Connections must be made exactly as specified to avoid system leaks and /or damage

1. Take out matching male connectors **M1** and **M2**.
2. **Remove** protective cap with the copper gasket at each stop valve on the **DC INVERTER** and ensure the threads are clean and complete.
3. **Tighten** the **M1** connector to the **cutoff valve *1** with a tightening force of 50N. **Tighten** the **M2** connector to the **cutoff valve *2** with a tightening force of 70N.
4. **Repeat** step 3 for **AIR HANDLER** at the other end of the **LINE SET**.
5. Unroll and route the **LINE SET** between the **AIR HANDLER** and the **DC INVERTER**.
6. **Remove** the protective caps of the valves at both ends of the **LINE SET**. Verify that all threads are clean and complete.
7. **Tighten** the **LINE SET F1** valve to the **M1 Connector** (attached in step 3) with a force of **45N**. **Tighten** the **LINE SET F2** valve to the **M2 Connector** (attached in step 3) with a tightening force of **45N**.
8. **Repeat** this process for the **AIR HANDLER** at the other end of the **LINE SET**.
9. At the **OUTDOOR UNIT** **remove** the **protective cap** at the **cutoff valve switch** and **open** the **cutoff valve** with a hex wrench to run the refrigeration circuit. **If** there is any fizz, grease or other **leakage**, **close** the valve **immediately** and **check** that **steps 3 and 7** were done properly. **Otherwise**, immediately **apply soapy water** for micro-leakage detection. Soak the joints using a sponge or spray bottle. **If any bubbles form**, **close** the valve **immediately** and **check** that **steps 3 and 7** were done properly.
10. **After** the correct connection, **re-tighten** the cutoff valve's **protection cap** and **cover** the M1, M2 and F1, F2 connections with the grey **insulating sleeve** to help **prevent condensation**.

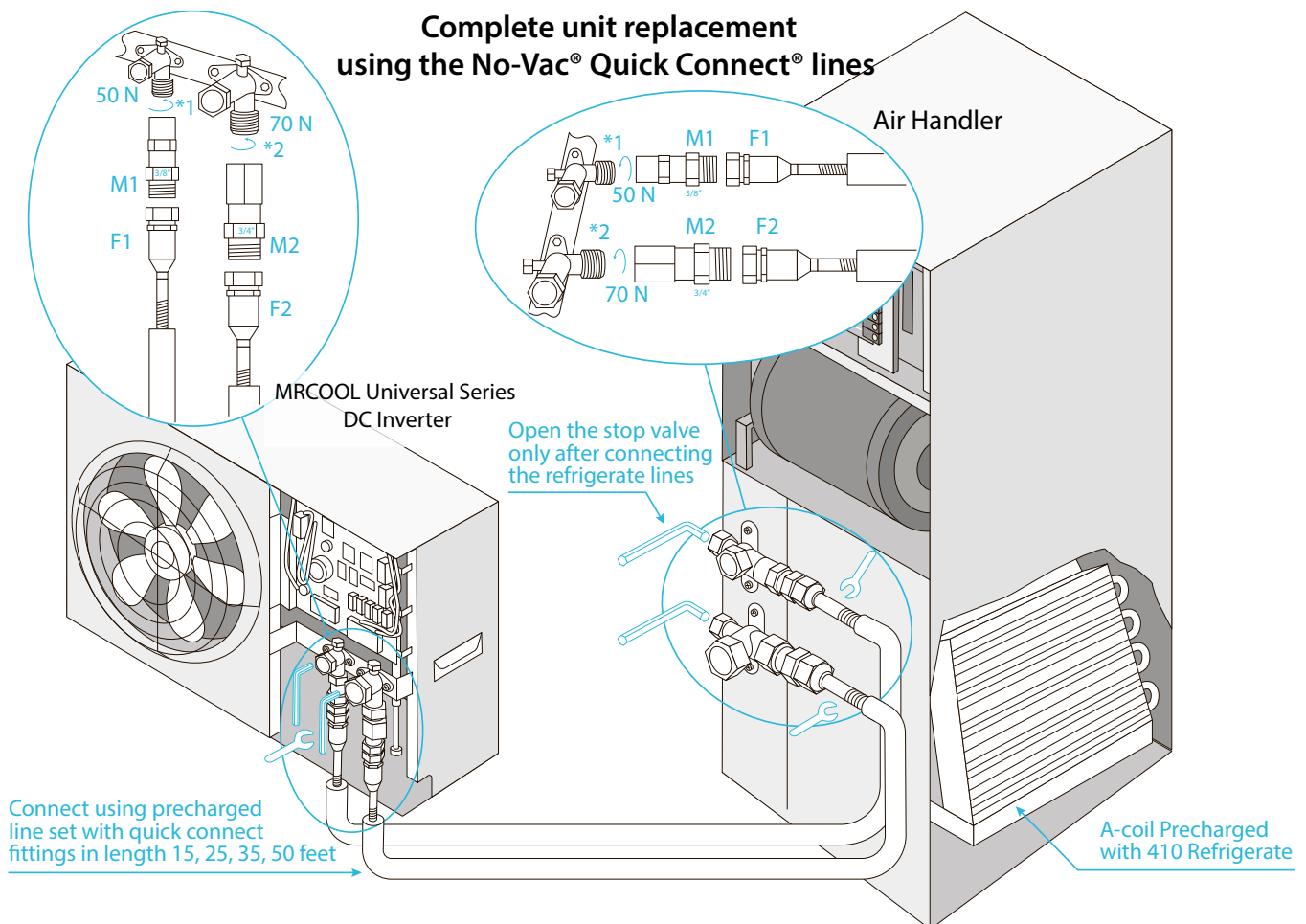

¹Failure to follow the instructions provided could result in severe harm to you, this product, or other property. The manufacturer, distributor, and seller are not responsible for any harm resulting from the failure to follow instructions and the failure to follow these instructions will void any and all warranties express or implied.

www.mrcool.com

v05-30-2019

Installation of Drain Pipe

If the outdoor unit is located on a level **lower** than the indoor unit, arrange the condensate drain according **Fig. 2.21**.

1. Drain hose should be placed on the ground and its end should not be immersed into water.
2. The entire lineset, including drain pipe should be wound with insulating tape. Wind the insulating tape from bottom to top.
3. The entire lineset, including drain pipe should be supported and fixed onto the wall with saddles.

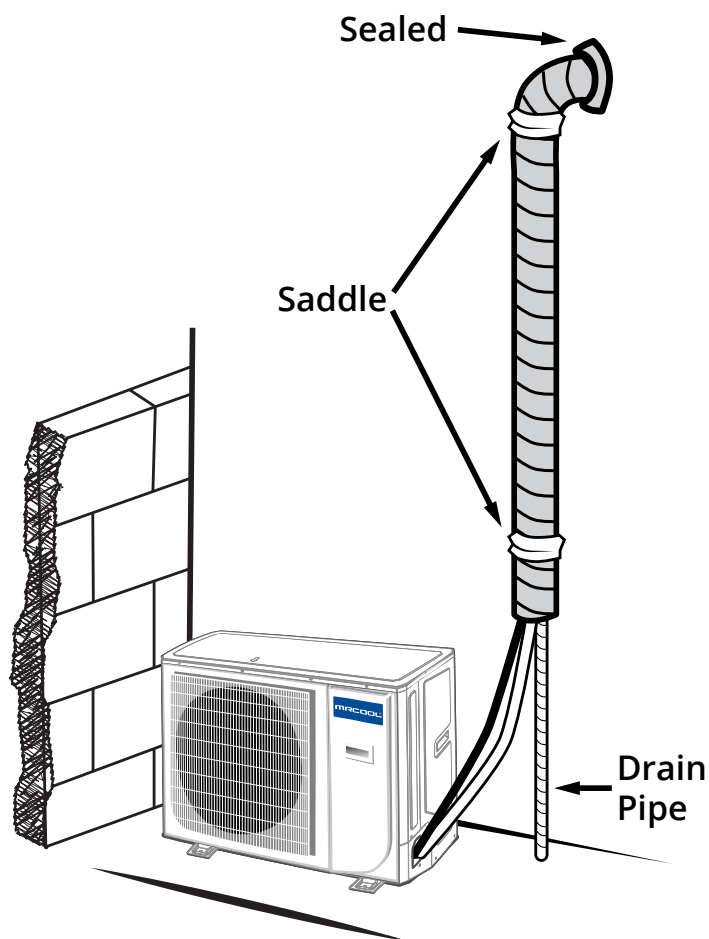

Fig. 2.21

If the outdoor unit is located on a level **higher** than the indoor unit, arrange the condensate drain according **Fig. 2.22**.

1. Drain hose should be placed on the ground utilizing a trap
2. The entire lineset, including drain pipe should be wound with insulating tape to avoid water returning to the interior. Wind the insulating tape from bottom to top.
3. The entire lineset, including drain pipe should be supported and fixed onto the wall with saddles.

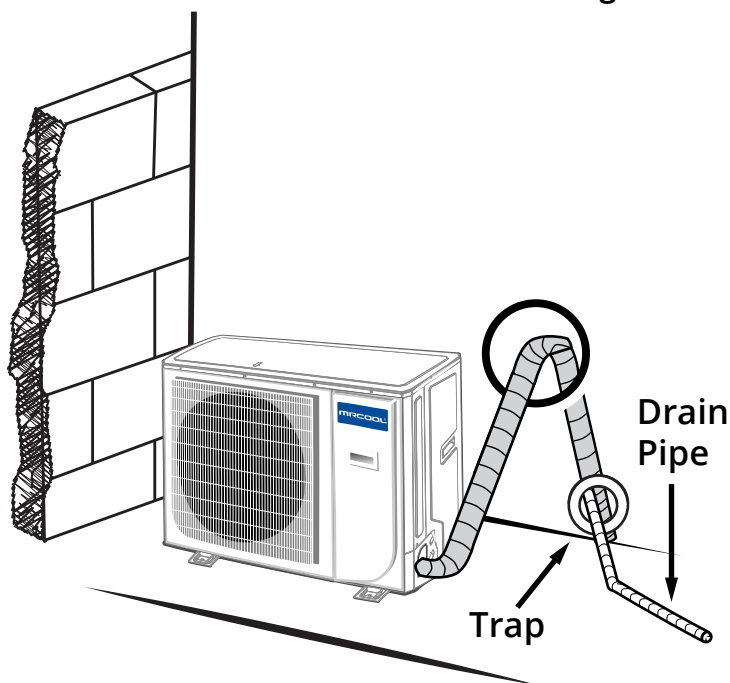

Fig. 2.22

Condenser Field Conversion

Converting Unit From 3 Ton to 2 Ton

Follow these instructions during unit installation in order to enable a Universal Series 3 ton condenser and air handler split system to operate at 2 ton capacity.

1. **DO NOT** attempt this conversion while the unit is powered on.
2. Locate the capacity dip switch on the condenser main board. The capacity dip switch is circled on the photo below.
3. The default position of the capacity dip switch is 1 & 2 'Up' and 3 & 4 'Down'. Up being a switch pushed toward the letters (ON DIP). Down being a switch pushed toward the numbers (1 2 3 4).
4. The default position of the capacity dip switch is 36k.
5. To activate the 24k capacity, flip capacity dip switch 1 from the Up position to the Down position.

Fig. 2.23

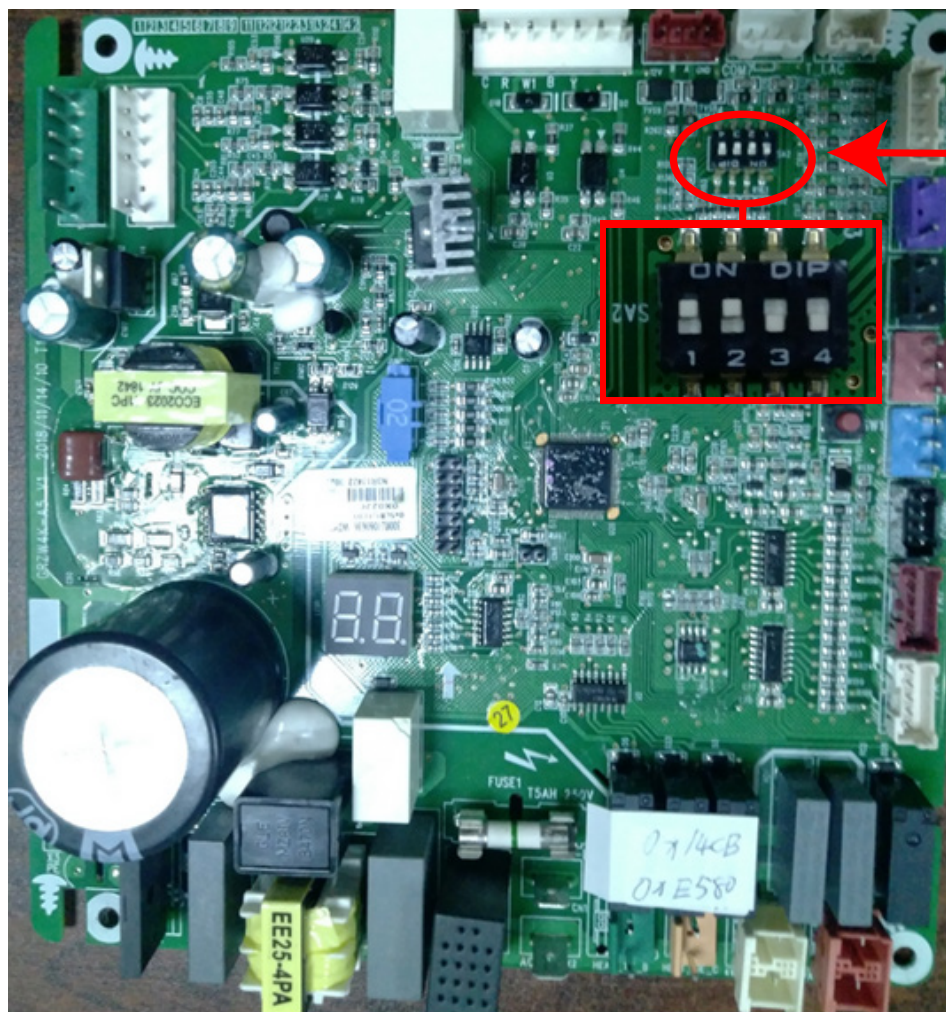

Location of Dip Switch on Condenser Main Board

Fig. 2.24



DEFAULT 3 TON

Fig. 2.25



2 TON SETTING

NOTE

Refer to the Universal Air Handler Installation Manual for Dip Switch Instructions and settings to convert the Universal Air Handler from 3 ton to 2 ton.

Electrical Connection

Electrical Regulations



WARNING Before performing electrical work, read the following regulations

1. Electrical installation must be conducted only by professionals in compliance with local laws, regulations and this installation manual. Never artificially extend the length of power cord. The electric circuit must be equipped with a circuit breaker and air switch. Both must have sufficient capacity.
2. Unit operating power must be within the nominal range stated in the instruction manual. Use a specialized power circuit for the air conditioner. Do not draw power from another power circuit.
3. The air conditioner circuit should be at least 1.5m away from any flammable surface.
4. The external power cord and the communication wire must be effectively fixed.
5. The external power cord and the communication wire must NOT directly contact any hot objects. For example: they must not come into contact with chimney pipes, warm gas pipes or other hot objects.
6. The external power cord and the communication wire must NOT be squeezed. Never pull, stretch or bend the wires.
7. The external power cord and the communication wire must NOT collide with any metal beam or edge on the ceiling, or touch any metal burrs or sharp metal edge.
8. Connect wires correspondingly by referring to the circuit diagram labeled on the unit or electric box. Screws must be tightened up. Slipped screws must be replaced by specialized flat-head screws.
9. Please use the power cables that are packaged with the appliance. Do not change the power cables arbitrarily. Do not change the length and terminals of the power cables. If you want to change the power cables, please contact MRCOOL's local service center.
10. Wiring terminals should be connected firmly to the terminal board. Loose connection is forbidden.
11. After the electrical installation is finished, please use wire clamps to secure the power cord, connection wire of temperature controller and outdoor unit and the communication cords. Make sure the wires are not clamped too tight.
12. The wire gauge of power cord should be sufficiently large. Damaged power cord or other wires must be replaced by specialized wires. Wiring work must be done according to national wiring rules and regulations.
13. This outdoor unit has a heating four-way valve.

Electrical Connection

Electrical Parameters

| Outdoor Unit Model | Power Supply | Min. Circuit Ampacity | Max. Fuse Size |
|--------------------|------------------------|------------------------------------|------------------------------------|
| MDUO18024036 | 208/230V 1Ph - 60Hz | 24 amps (3 Ton) 18 amps (2 Ton) | 35 amps (3 Ton) 20 amps (2 Ton) |

Connecting the Power Cord & Communication Wire

For solid wires (Refer to **Fig. 2.26 A**):

1. Use wire cutters to cut off the wire end and then peel away about 25mm of the insulation layer.
2. Use a screwdriver to unscrew the terminal screw on the terminal board.
3. Use nippers to bend the solid wire into a ring that fits the terminal screw.
4. Form a proper ring and then put it on the terminal board. Use a screwdriver to tighten up the terminal screw

For braided wires (Refer to **Fig. 2.26 B & Fig. 2.27**):

1. Use wire cutters to cut off the wire end and then peel away about 10mm of the insulation layer.
2. Use a screwdriver to unscrew the terminal screw on the terminal board.
3. Use a round terminal fastener or clamp to fix the round terminal firmly on the peeled wire end.
4. Locate the round terminal conduit. Use a screwdriver to replace it and tighten up the terminal screw (as shown in **Fig. 2.27**).

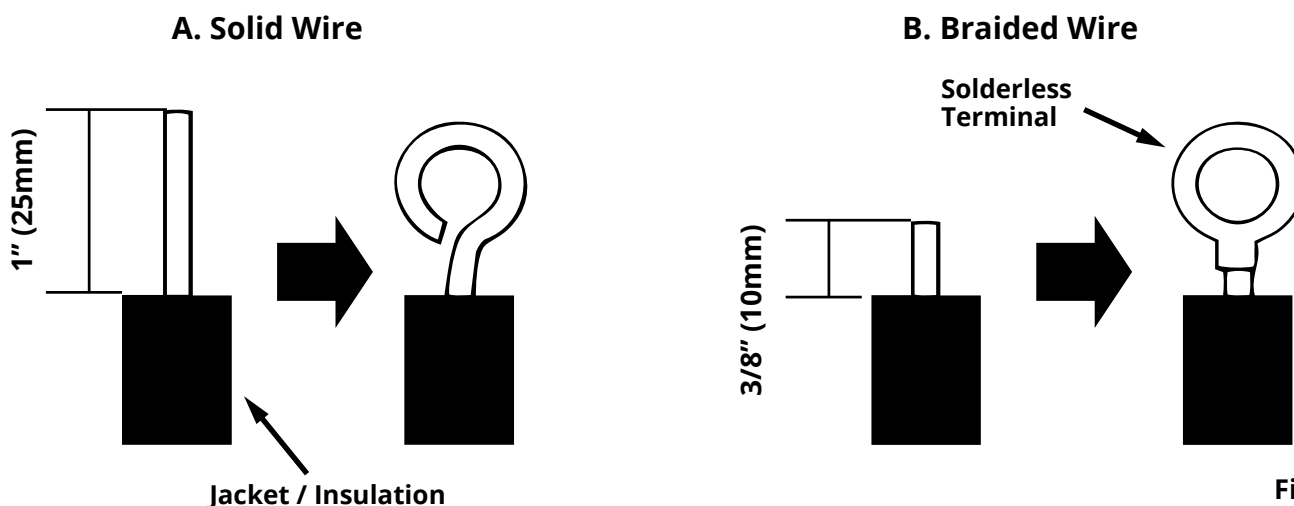

Fig. 2.26

Electrical Connection

Connecting the Power Cord & Communication Wire



WARNING

1. Before work begins, please check to ensure the unit is powered OFF.
2. Improper wire connection may cause electrical components to burn.
3. Connect the wires firmly to the wiring box. Incomplete installation may create a fire hazard.
4. Use wire clamps to secure the external covers of connecting wires. Insulators must be clamped securely; otherwise, electrical leakage may occur.
5. Ground wire must be connected.

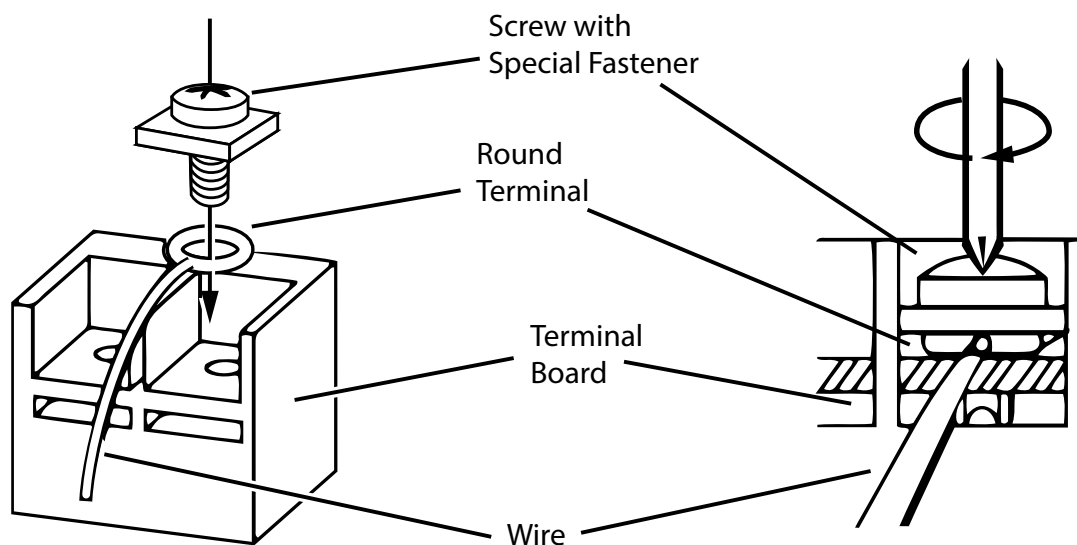

Fig. 2.27

For all terminal wiring (Refer to Fig. 2.28):

Lead the connection wire and power cord through the insulation tube. Then fix the wires with wire clamps (as shown in Fig. 2.28).

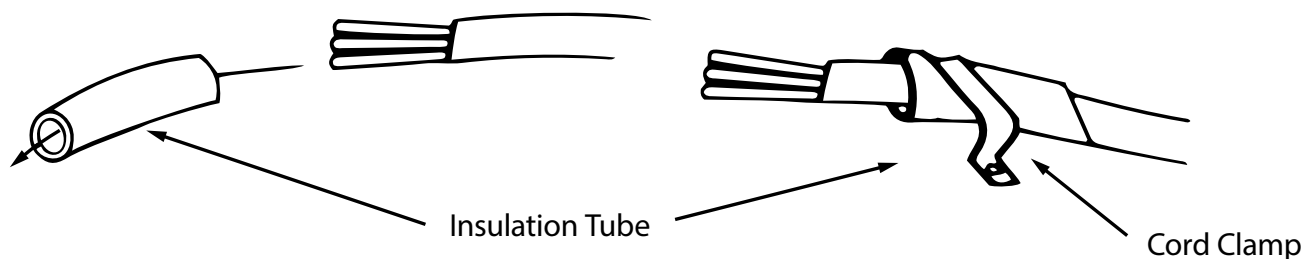

Fig. 2.28

Electrical Connection

Connecting the Power Cord & Communication Wire



WARNING

1. High and low voltage wires should be led through different rubber rings of the electric box cover.
2. Do not bundle up the temperature controller wire or lay them side by side, otherwise errors will occur.
3. High and low voltage wires should be secured separately. Secure the former ones with large clamps and the latter ones with small clamps.
4. Use screws to tighten the power cord and communication wire of the units on the terminal board. Improper connection may create a fire hazard.
5. If the power cord and communication wire are not correctly connected, the air conditioner may suffer damage.
6. Ground the units through connecting the ground wire.
7. The units should comply with applicable local and national rules and regulations on power consumption.
8. When connecting the power cord, make sure the phase sequence of the power supply matches with the corresponding terminals, otherwise the compressor will get reversed and operate abnormally.

Electrical wiring of Single-phase unit: MDUO18024036

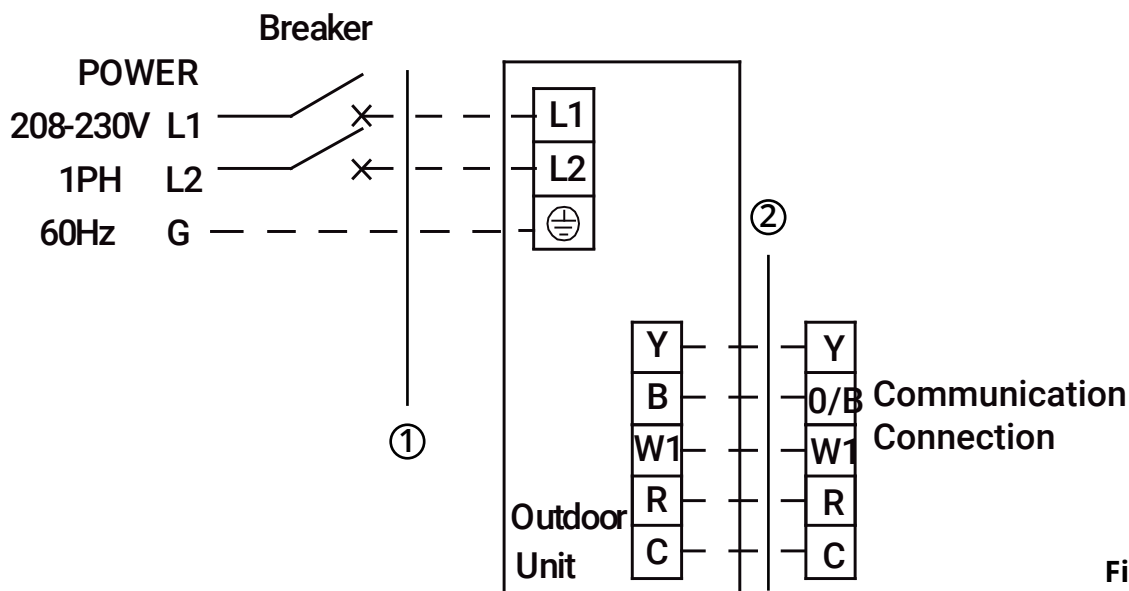

Fig. 2.29-A

Electrical Connection

Connecting the Power Cord & Communication Wire

1. Remove the big handle/front panel of the outdoor unit and insert one end of the communication wire and the power cord to the terminal board.
2. The power cord should be secured along with the right side plate and fixed to the hook with a wire clamp so as to avoid contacting the pipeline. The temperature controller wire should also be laid along with the right side plate but away from the power cord.

Electrical wiring of Single-phase unit: MDUO18024036

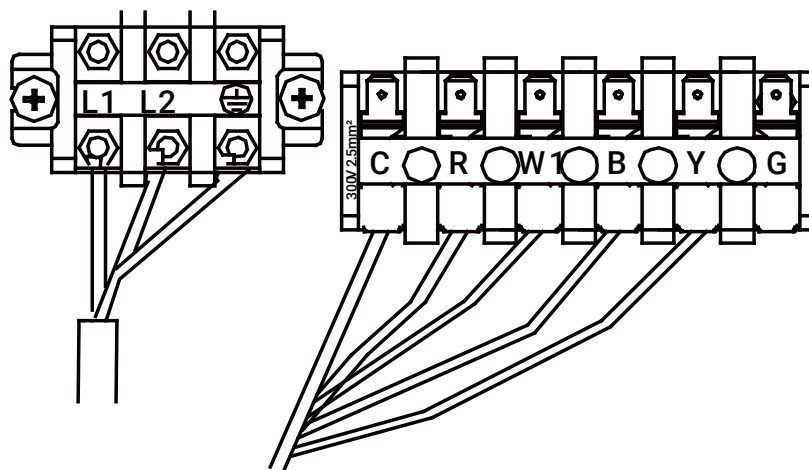

Fig. 2.29-B

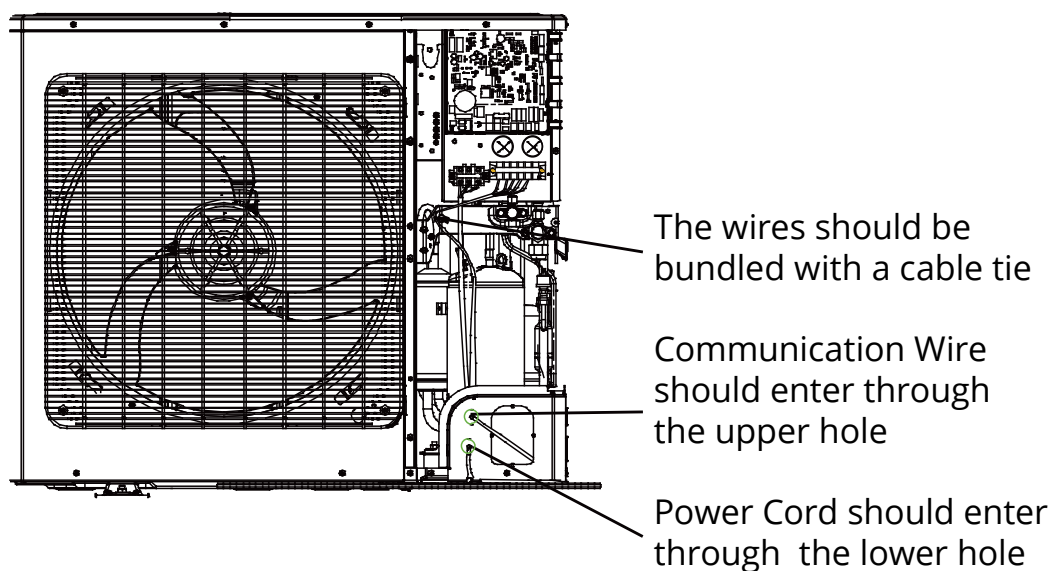

Fig. 2.30

Before Test Run

Only perform test run after you have completed the following steps:

- **Electrical Safety Checks** – Confirm that the electrical system is safe and operating properly
- **Gas Leak Checks** – Check all flare nut connections and confirm that the system is not leaking
- Confirm that gas and liquid (high and low pressure) valves are fully open

| List of Checks to Perform | Possible Malfunctions | PASS/FAIL | |
|---|--|--------------|-------------|
| Is the main body installed securely? | The unit may fall down, vibrate or produce noise. | | |
| Did you conduct a water leakage test? | Cooling capacity may become unsatisfactory. | | |
| Is the unit well insulated from heat? | Condensate, water drops may occur | | |
| Does water drain properly from drain hose? | Condensate, water drops may occur | | |
| Is the voltage consistent with that stated on the nameplate? | The unit may fail or its components may get burned. | Outdoor (2): | Indoor (2): |
| Are the wires and pipes installed correctly? | The unit may fail or its components may ignite. | | |
| Has the unit been safely grounded? | Risk of electric leakage. | | |
| Do the specifications of wires comply with the requirement? | The unit may fail or its components may ignite. | | |
| Is there any obstacle blocking the air inlet and outlet of the units? | Cooling capacity may become unsatisfactory. | | |
| Have you recorded the length of refrigerant pipe and the refrigerant charging amount? | The refrigerant charging amount can't be controlled. | | |
| | | | |

Test Run

DOUBLE-CHECK PIPE CONNECTIONS

During operation, the pressure of the refrigerant circuit will increase. This may reveal leaks that were not present during your initial leak check. Take time during the Test Run to double-check that all refrigerant pipe connection points do not have leaks.

Test Run Instructions

Preparation before connecting the power:

1. Power must not be connected if the installation work is not completed.
2. Control circuit is correct and all the wires are firmly connected.
3. Cut-off valves of the gas pipe and liquid pipe are open.
4. The inside of the unit should be clean. Take irrelevant objects out if there is any.
5. After checking, re-install the front side plate.

Operation after connecting the power:

1. If all the above works are finished, power on the unit.
2. If the outside temperature is more than 30°C, heating mode can't be enabled.
3. Make sure the units can run normally.
4. If there are any loud and/or abnormal sounds contact MRCOOL Tech Support immediately.

NOTICE:

1. If you use remote control to turn off the unit and then immediately turn the unit on again, compressor will need 3min to restart. Even if you press "ON/OFF" button on the remote control, it won't be started up right away.
2. If there's no display on the wired control Change to: temperature controller, it's probably because the connection wire between the units and wired control Change to: temperature controller is not connected. Please check again.

Troubleshooting

(1) If your air conditioner fails to function normally, check the following items before conducting maintenance:

| Problem | Cause | Corrective Measure |
|---|--|--|
| The air conditioner will not activate. | If you turn off the unit and then immediately turn it on, in order to protect the compressor and avoid system overload, compressor will delay running for 3 minutes. | Please wait for approx. 3 minutes. |
| | Wire connection is wrong. | Connect wires according to the wiring diagram. |
| | Fuse or circuit breaker is broken. | Replace the fuse or switch on the circuit breaker. |
| | Power failure. | Restart after power returns. |
| | Power plug is loose. | Re-insert the power plug. |
| | Remote control has low battery. | Replace the batteries. |
| Inadequate cooling or heating performance | Air inlet and outlet of the units have been blocked. | Clear the obstacles and keep the area well ventilated. |
| | Improper temperature setting. | Reset to a proper temperature. |
| | Fan speed is too low. | Reset to a proper fan speed. |
| | Air flow direction is incorrect. | Change the direction of air louvers. |
| | Doors or windows are open. | Close them. |
| | Exposed under direct sun light. | Put on curtains or louvers in front of the windows. |
| | Too many heat sources in the room. | Remove unnecessary heat sources. |
| | Filter is blocked or dirty. | Have a professional clean the filter. |
| | Air inlet and outlet of the units have been blocked. | Clear the obstacles and keep the area well ventilated. |

Maintenance

(2) The following situations are not operation failures.

| Problem | Time of Occurrence | Cause |
|---------------------------------------|--|---|
| Mist comes from the conditioner. | During operation. | If the unit is running under high humidity, the wet air in the room will be quickly cooled down. |
| The air conditioner generates noise. | System switches to heating mode after defrosting. | Defrosting process will generate some water, which will turn to vapor. |
| | The air conditioner is buzzing when operation begins. | Temperature control will be buzzing when it starts working. The noise will become weak 1 minute later. |
| Dust comes from the air conditioner. | When the unit is turned on, it purrs. | When the system has just started, the refrigerant is not stable. About 30 secs later, the purr of the unit becomes low. |
| | About 20 secs after the unit first enables heating mode or when defrosting under heating mode. | It's the sound of the 4-way valve switching direction. The sound will disappear after the valve is in position. |
| | There is a hissing sound when the unit has started or stopped and a slight hissing sound during and after operation. | It's the sound of gaseous refrigerant that stops flowing and the sound of the drainage system. |
| | There is a crunching sound during and after operation. | Because of temperature change, the front panel and other components may swell and cause an abrasive sound. |
| | There is a hissing sound when the unit is turned on or suddenly stopped during operation or after defrosting. | Because refrigerant suddenly stops flowing or changes the flow direction. |
| | The unit starts operation after being unused for a long time. | Dust inside the units come out together with the air. |
| The air conditioner generates smells. | During operation. | Smells from the operating environment may be conducted through the air handler. |



NOTICE

Check the above items and take appropriate corrective measures. If the air conditioner continues improper function, please turn off the air conditioner immediately and contact MRCOOL or your installing dealer.

Error Code



WARNING

- 1) **When abnormalities occur, stop the unit immediately and disconnect power. Contact MRCOOL. If the unit continues to run abnormally, it may damage the unit and cause an electric shock or a fire hazard.**
- 2) **DO NOT attempt repairs to the appliance yourself. Improper repair and maintenance can create electric shock and fire hazards. Please contact MRCOOL Tech Support for further guidance or a qualified professional for repairs.**

If the display panel or wired control displays an error code, please refer to the following table:

| Number | Error Code | Error |
|--------|------------|---|
| 1 | E1 | Compressor high pressure protection |
| 2 | E4 | Compressor air discharge high-temperature protection |
| 3 | E3 | Compressor low pressure protection, refrigerant lack protection and refrigerant collecting mode |
| 4 | F2 | Condenser temperature sensor error |
| 5 | F3 | Outdoor ambient temperature sensor error |
| 6 | F4 | Discharge temperature sensor error |
| 7 | F6 | Outdoor unit tube temperature sensor error |
| 8 | C5 | Indoor unit jumper cap error |
| 9 | EE | Outdoor unit memory chip error |
| 10 | PF | Electric box sensor error |
| 11 | H3 | Compressor overload protection |
| 12 | H4 | Overload |
| 13 | H5 | IPM protection |
| 14 | H6 | DC fan error |
| 15 | H7 | Driver out-of-step protection |
| 16 | HC | Pfc protection |
| 17 | Lc | Startup failure |
| 18 | Ld | Compressor phase-sequence protection |
| 19 | LF | Power protection |
| 20 | U7 | 4-way valve switch-over error |
| 21 | P0 | Drive reset protection |

Maintenance

| Number | Error Code | Error |
|--------|------------|---|
| 22 | P5 | Over-current protection |
| 23 | P6 | Master control and driver communication error |
| 24 | P7 | Driver module sensor error |
| 25 | P8 | Driver module high temperature protection |
| 26 | P9 | Zero-crossing protection |
| 27 | PA | AC current protection |
| 28 | Pc | Driver current error |
| 29 | Pd | Sensor connection protection |
| 30 | PE | Temperature drift protection |
| 31 | PL | Bus low-voltage protection |
| 32 | PH | Bus high-voltage protection |
| 33 | PU | Charge loop error |
| 34 | PP | Input voltage error |
| 35 | ee | Driver memory chip error |
| 36 | C4 | ODU jumper cap error |



NOTICE

When the unit is connected with the wired controller, the error code will show simultaneously on it.

Unit Maintenance



Warning

- 1) Only professionals may carry out annual maintenance.
- 2) Before contacting any wire, make sure power is turned off.
- 3) Do not allow flammable objects near the unit.
- 4) Do not use organic solvent to clean the air conditioner.
- 5) If you need to replace a component, contact a professional to repair the unit with a component supplied by MRCOOL to ensure the quality.
- 6) Improper operation may damage the unit, causing electric shock or fire.
- 7) Do not immerse the air conditioner in water or electric shock may occur. Do not use water to rinse the unit during cleaning.

Unit Maintenance



Warning

- 1) Before cleaning, ensure the power is off. Turn off at circuit breaker and remove the power socket, to avoid electric shock.
- 2) Do not wash the air conditioner with water, otherwise fire or electric shock may occur.
- 3) When cleaning the filter, be careful. If you need to work above the ground, please exercise caution.

Outdoor Heat Exchanger

Clean the heat exchanger on the outdoor unit periodically — at least once every two months. Remove the dust and sundries on the surface of the heat exchanger with dust collector and nylon brush. If there is a compressed air source; use the compressed air to gently blow the dust off the surface of the heat exchanger. Do not use tap water for cleaning.

Condensate Drain

Periodically check if the condensate drain is blocked to avoid condensate water problems.

Pre-Season Inspection Check List

- 1) Check for blockages in the air inlet/outlet;
- 2) Check the ground connection;
- 3) Check the battery in the remote control;
- 4) Check that the air filter screen is properly installed and clean;
- 5) If starting up again after a long period of inactivity, present the power switch of the air conditioner to "ON" status at least 8 hours prior to operation to preheat the crankcase on the compressor.
- 6) Check that the outdoor unit is firmly secured;
- 7) If problems are detected, contact your local service professional or MRCOOL.

Post-Season Maintenance Check List

- 1) Deactivate the main power to the air conditioner;
- 2) Remove dust and debris from the outdoor unit;
- 3) If the outdoor unit is rusty, paint the rusty location to prevent it from growing.

Component Replacement

Components are available from MRCOOL and associated dealers.

Notice on Maintenance

Service Information

The manual contains specific information for service personnel who will perform maintenance on the product.

General Work Area

Inform others working in the immediate vicinity about the nature of work being performed. Avoid work confined spaces. Section off the area around the workspace. Ensure conditions within the area are safe by removing potentially flammable material.

Ventilated Area

Ensure the area is adequately ventilated before opening into the system or conducting any refrigerant work. Maintain adequate ventilation while working. Effective ventilation will safely disperse any released refrigerant into the atmosphere.

Refrigeration Equipment Checks

Ensure all electrical components are compatible with the product and built to the correct specifications. Follow manufacturer maintenance and service guidelines at all times. When in doubt, consult the MRCOOL's technical department for assistance.

If using flammable refrigerants, conduct the following checks:

- 1) Ensure ventilation machinery and outlets are operating adequately and are not obstructed;
- 2) If an indirect refrigerating circuit is being used, check the secondary circuit for the presence of refrigerant;
- 3) Check that equipment markings are visible and legible. Replace markings that are illegible.
- 4) Ensure refrigeration pipe or components are installed in a position where they are unlikely to be exposed to any substance which may corrode refrigerant containing components unless the components are constructed of materials which are inherently resistant to being corroded or are suitably protected against being so corroded.

Electrical Device Checks

Electrical component repair and maintenance should include initial safety checks and component inspection procedures. If a fault exists that could compromise safety, do not connect the circuit to an electrical supply until the fault is corrected.

Electrical Device Checks

Initial safety checks should include:

- 1) Safe discharge of capacitors to avoid the possibility of sparking;
- 2) No live electrical components and wiring should be exposed while charging, recovering or purging the system;
- 3) The system is safely grounded.

Sealed Component Repairs



ELECTRICAL SAFETY

Ensure that this system is installed using a disconnect box that meets national, state, and local electrical and HVAC code requirements. The location of the disconnect box(es), number of disconnect boxes needed, and distance from the unit(s) to the disconnect box(es) should be handled in accordance with national, state, and local electrical and HVAC code.



ATTENTION

- 1) **Electrical component casings should not be altered in such a way that the level of protection is affected. This includes damage to cables, excessive number of connections, terminals not made to original specification, damage to seals, incorrect fitting of glands, etc.**
- 2) **Ensure the apparatus is securely mounted.**
- 3) **Ensure the seals or sealing materials have not degraded in such a way that they no longer serve the purpose of preventing the ingress of flammable atmospheres. Replace parts in accordance with manufacturer specifications.**



NOTICE

The use of silicon sealant may inhibit the effectiveness of some types of leak detection equipment. Intrinsically safe components do not have to be isolated prior to working on them.

Intrinsically Safe Component Repair

- 1) Do not apply any permanent inductive or capacitance loads to the circuit without ensuring that this will not exceed the permissible voltage and current permitted for the equipment in use.
- 2) Intrinsically safe components are the only types that can be worked on while live in the presence of a flammable atmosphere. The test apparatus must be at the correct rating.
- 3) Replace components only with parts specified by the manufacturer. Other parts may result in the ignition of refrigerant in the atmosphere from a leak.

Notice on Maintenance

Cabling

Check that cabling will not be subject to wear, corrosion, excessive pressure, vibration, sharp edges or any other adverse environmental effects. The check should also take into account the effects of ageing or continual vibration from sources such as compressors or fans.

Charging Procedures

In addition to conventional charging procedures, the following parameters must be followed:

- 1) Ensure refrigerant contamination does not occur when charging equipment.
- 2) Hoses or lines should be as short as possible to minimize the refrigerant contained in them.
- 3) Cylinders must be kept upright.
- 4) Take extreme care to avoid refrigerant overfill.
- 5) Label the system when charging is complete (if not already).
- 6) Extreme care shall be taken not to overfill the refrigeration system.
- 7) Prior to recharging the system pressure test with OFN. The system must be leak tested when charging is complete and prior to commissioning. A follow up leak test must be carried out before leaving the site.

Decommissioning

Before decommissioning, it is essential that the technician become completely familiar with all of the equipment in detail. It is a recommended good practice that all refrigerants be recovered safely. Before decommissioning, an oil and refrigerant sample should be taken in case analysis is required prior to re-use of reclaimed refrigerant. It is essential that electrical power is available before the task is commenced.

Before decommissioning procedure ensure that:

- 1) You are familiar with the equipment and its operation.
- 2) The system has been isolated electrically.
- 3) Mechanical handling equipment is available, if required, for handling refrigerant cylinders.
- 4) All personal protective equipment is available and being used correctly.
- 5) The recovery process is supervised at all times by a competent person.
- 6) Recovery equipment and cylinders conform to the appropriate standards.

Decommissioning procedure:

- 1) Pump down refrigerant system, if possible.
- 2) If a vacuum is not possible, make a manifold so that refrigerant can be removed from various parts of the system.
- 3) Make sure that cylinder is situated on the scales before recovery takes place.
- 4) Start the recovery machine and operate in accordance with manufacturer's instructions.
- 5) Do not overfill cylinders. No more than 80% volume liquid charge.

Notice on Maintenance

Decommissioning (cont.)

- 6) Do not exceed the maximum working pressure of the cylinder, even temporarily.
- 7) When the cylinders have been filled correctly and the process completed, ensure the cylinders and the equipment are removed from site promptly and all isolation valves on the equipment are closed.
- 8) Recovered refrigerant must not be charged into another refrigeration system until it has been cleaned and checked.

Labelling

Equipment should be labelled to state that it has been de-commissioned and emptied of refrigerant. The label must be dated and signed.

Recovery

When removing refrigerant from a system, either for servicing or decommissioning, it is a recommended good practice that all refrigerants are removed safely.

When transferring refrigerant into cylinders, ensure that only appropriate refrigerant recovery cylinders are employed. Ensure that the correct number of cylinders for holding the total system charge are available. Ensure that all cylinders to be used are designated for the recovered refrigerant and labelled for that refrigerant. Cylinders should be complete with pressure relief valve and associated shut-off valves in good working order.

In addition, a set of calibrated weighing scales shall be available and in good working order. Hoses shall be complete with leak-free disconnect couplings and in good condition. Before using the recovery machine, check that it is in satisfactory working order and has been properly maintained. Consult the manufacturer if in doubt.

The recovered refrigerant should be returned to the refrigerant supplier in the correct recovery cylinder, and the relevant Waste Transfer Notice arranged. Do not mix refrigerants in recovery units and especially not in cylinders.

If compressors or compressor oils are to be removed, ensure that they have been evacuated to an acceptable level to make certain that flammable refrigerant does not remain within the lubricant. The evacuation process shall be carried out prior to returning the compressor to the suppliers. Only electric heating to the compressor body shall be employed to accelerate this process. When oil is drained from a system, it shall be carried out safely.

After-Sales Services

Any quality or other issues encountered in the purchased air conditioner, please contact the local MRCOOL after-sales service department.

This appliance contains refrigerant and other potentially hazardous materials. When disposing of this appliance, the law requires special collection and treatment. **DO NOT** dispose of this product as household waste or unsorted municipal waste.

When disposing of this appliance, you have the following options:

- Dispose of the appliance at a designated municipal electronic waste collection facility.
- When buying a new appliance, the retailer will receive the old appliance free of charge.
- The manufacturer will receive the old appliance free of charge.
- Sell the appliance to certified scrap metal dealers.

Special notice

Disposing of this appliance in the forest or other natural surroundings endangers your health and is bad for the environment. Hazardous substances may leak into the ground water and enter the food chain.

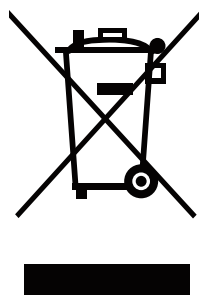



MRCOOL®

COMFORT MADE SIMPLE

Universal™ Series

ELECTRICIAN and/or HVAC TECHNICIAN:

LICENSE #:

INSTALLATION DATE:

INSTALLATION LOCATION:

SERIAL NUMBER: