

Please read this manual carefully before installation and keep it for future reference.

Owner & Installation Manual



MRCOOL®

COMFORT MADE SIMPLE

UNIVERSAL®

A-Coils

Model: MDUCC150**

Due to updates and constantly improving performance, the information and instructions within this manual are subject to change without notice. Please visit www.mrcool.com/documentation to ensure you have the latest version of this manual.

Version Date: 9-02-21

Thank you for choosing MRCOOL. Please read this manual carefully before installation and keep it for future reference.

Copyright © 2021 MRCOOL, LLC

1	Safety Precautions	2
2	Product Information	3
2.1	Product Description	4
2.2	Main Components	4
2.3	Physical Dimensions	5
2.4	Cooling Capacity Range.....	5
3	Unit Installation	6
3.1	Pre-Installation Instructions	6
3.2	Location	6
3.3	A-Coil Orientation/Position Options	7
3.4	Refrigerant Piping Connection	8
	Optional Quick-Connect Line set Installation	10
	Bending the Line Set	11
3.5	Condensate Removal	11
3.6	Ductwork	12
3.7	Unit Installation	12
3.8	Sealing Ducts	12
3.9	Leak Testing, Evacuating and Charging	12
4	Blower Speed Selection	13
5	Maintenance and Care	14
5.1	Condensate Pipe	14
5.2	Checklist Before Seasonal Use	14
5.3	Maintenance after Seasonal Use	14
5.4	Parts Replacement	14
6	After-Sales Service	15

Safety Precautions

1

Read Before Installation

Incorrect installation may cause serious damage or injury.

The seriousness of potential damage or injuries is classified as either a **WARNING** or **CAUTION**.



This symbol indicates ignoring instructions may cause death or serious injury.



This symbol indicates that ignoring instructions may cause moderate personal injury, damage to your unit, or other property.



This symbol indicates that you should **NEVER** perform the indicated action.

WARNING

Please read the manual in its entirety and be aware of all warnings and cautions before installing, operating, or repairing.

- ① ***DO NOT*** install this unit in a corrosive, inflammable, or explosive environment.
 - ① ***DO NOT*** install in any environment with special requirements, such as a kitchen. These factors will affect the normal operation or shorten the service life of the unit and could cause a fire hazard or lead to serious injury. If a unit needs to be installed in an environment with special requirements, please find a unit made specifically for this purpose that has anti-corrosive and anti-explosion functions.
1. Installation must be performed by an authorized technician. Improper installation, adjustment, alteration, service, maintenance, or use could cause fire, explosion, electrical shock, property damage, personal injury, or death. The services of a professional installer are **NOT** required when using the MRCOOL® No Vac® Quick Connect® Line Set for the installation.
 2. Follow all safety codes.
 3. Wear safety glasses, protective clothing, and work gloves.
 4. Always use a quenching cloth for brazing operations.
 5. Have a fire extinguisher available and on hand in case of emergency.
 6. In North America, installation must be performed in accordance with the requirements of the NEC and CEC (by authorized personnel only). Consult local building codes and NEC for special requirements.
 7. The qualified installer or agency must use factory-authorized kits or accessories when installing or modifying this product. Refer to the individual instructions packaged with the kits or accessories when installing. Using non-standard parts could cause water leakage, electrical shock, fire and could cause the unit to fail.
 8. **ELECTRICAL SHOCK HAZARD: Failure to follow this warning could result in personal injury or death. Before installing, modifying, or servicing system, the main electrical disconnect switch must be in the OFF position. There may be more than one disconnect switch. Lock out and tag switch with a suitable warning label.**

CAUTION

As with any mechanical equipment, contact with sharp sheet metal edges can result in personal injury. Be careful while handling this equipment and wear gloves and protective clothing.

To Our Customers;

Thank you for choosing a MRCOOL® home HVAC product. Please read this manual carefully before installation and operation of the Universal® Series A-Coils to ensure correct use and handling. In addition to the safety precautions in the previous section, please adhere to the following guidelines and note our exceptions to liability.

1. This appliance can be used by children aged 8 years and older and persons with reduced physical, sensory or mental capabilities or lack of experience and knowledge if they have been given supervision or instruction concerning use of the appliance in a safe way and understand the hazards involved. Children should not play with the appliance. Cleaning and user maintenance should not be performed by children.
2. To ensure product reliability, the unit may consume power under stand-by status to maintain normal communication, and for preheating refrigerant and lubricant. If the unit will not be used for an extended period, disconnect the power supply. Reconnect the power supply and preheat the unit prior to use.
3. Ensure you have selected the proper model for the operating environment. Improper selection may impact operating performance.
4. This product has undergone strict inspection and operational testing before leaving the factory. In order to avoid damage due to improper disassembly, which may impact the normal operation, please do not disassemble the unit without the proper training and/or equipment.
5. For technical assistance, please contact MRCOOL® technical support, at (270) 366-0457.
6. If the product is malfunctioning and/or is inoperable, please contact MRCOOL® technical support at the aforementioned number, as soon as possible and provide the following information:
 - a. Product Nameplate Contents (model number, cooling/heating capacity, product serial number, factory date)
 - b. Nature of Malfunction (specify the circumstances before and after the error occurred)
7. All illustrations and information in the instruction manual are for reference only. In order to improve the product, we will continuously assess and innovate. We retain the right to make necessary revisions to the product from time to time. We reserve the right to revise the contents of this manual without notice.
8. If the supply cord is damaged, it must be replaced by MRCOOL®, a professional service agent, or a similarly qualified person in order to avoid damage to the product.
9. MRCOOL®, LLC assumes no responsibility for personal injury, property loss or equipment damage caused by improper installation and commissioning, unnecessary maintenance, or failure to follow relevant federal and state regulations, industrial standards, and the requirements of this instruction manual.
10. MRCOOL®, LLC will bear no responsibilities for personal injury or property damage caused by the following:
 - a. Improper use of the appliance
 - b. Altering, maintaining, or operating the product with non-approved equipment.
 - c. Altering, maintaining, or operating the product outside of the guidelines of this manual.
 - d. Defects caused by corrosive gas.
 - e. Defects caused by shipping damage.
 - f. Failure to abide by this instruction manual or government regulations.
 - g. Products made by other manufacturers
 - h. Natural disasters, improper installation environment, or force majeure.

2.1 Product Description

The Universal Series® A-Coil offers the perfect combination of superior product quality, operating efficiency, and value for money. The evaporator unit uses the environmentally friendly refrigerant R-410A, which is chlorine-free to help prevent damage to the ozone layer.

2.2 Main Components

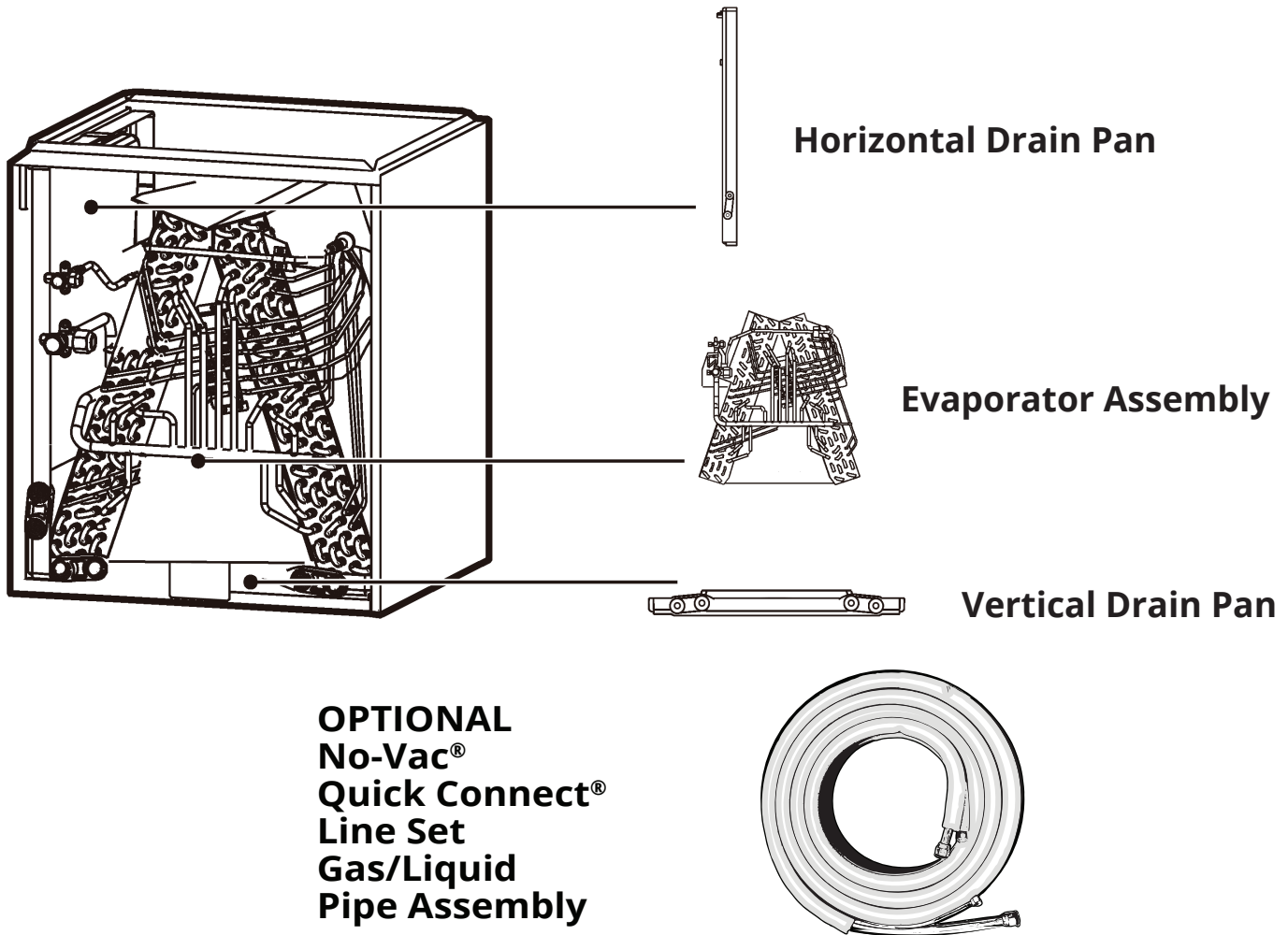

Additional Line Sets & Coupler Kit				
	If you find the standard size NO-VAC® QUICK CONNECT® LINE SET length is not sufficient for your application, additional line sets are available for purchase. You will also need a NO-VAC® COUPLER kit (pictured), which allows line sets to be connected together to increase the length. The coupler kit is installed and checked for leaks by following the same steps described in this manual for connecting the line set to the indoor air handler (Refer to the NO-VAC® QUICK CONNECT® Line Set section on pg. 10 for these steps).			
	NO-VAC® QUICK CONNECT® LINE SET Lengths Available	15 FT	25 FT	35 FT

2.3 Physical Dimensions

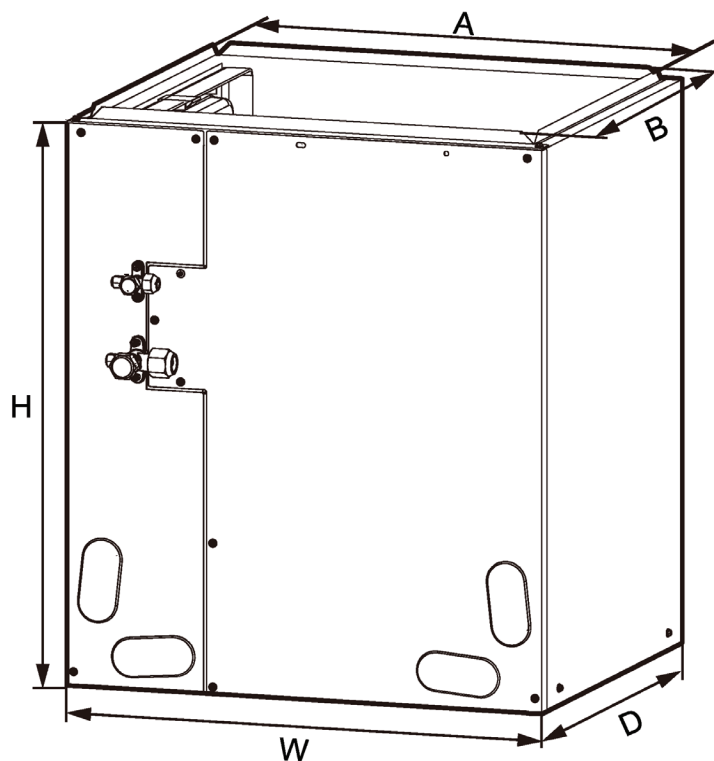

Units: inch(millimeter)

Model	Dimension				
	W	D	H	A	B
MDUCC15024/ MDUCC15036	17-1/2 (445)	21-1/4 (540)	23 (584)	15-7/8 (403)	19-3/8 (492)
MDUCC15048/ MDUCC15060	24-1/2 (622)	21-1/4 (540)	28-1/2 (724)	22-7/8 (581)	19-3/8 (492)

2.4 Cooling Capacity Range

Cooling capacity range as shown below:

Model	Cooling capacity(ton)
MDUCC15024	2.0
MDUCC15036	3.0
MDUCC15048	4.0
MDUCC15060	5.0

WARNING

The evaporator of the indoor unit is charged with refrigerant from the factory to maintain pressure. The cut-off valve can only be opened when the installation process and vacuuming procedure of the system have been completed.

3.1 Pre-Installation Instructions

3.1.1 Checking Product Received

After receiving the product, please check it for damage that may have been caused during shipping. Shipping damage is the responsibility of the carrier. Verify the model number, specifications, and accessories are correct prior to installation. The distributor or manufacturer will not accept claims from dealers for shipping damage or installation of incorrectly shipped units.

3.1.2 Before Installation

Carefully read all instructions for the installation prior to beginning the installation. Make sure you understand each step or procedure, and that any special considerations are taken into account before starting the installation. Some tools or items for the installation may need to be purchased locally. Make sure everything that is needed to complete the installation is on hand before you begin.

3.1.3 Codes & Regulations

This product is designed and manufactured to comply with national codes. It is the responsibility of the installer to ensure that the product is installed in accordance with such codes and/or any prevailing local codes & regulations. The manufacturer assumes no responsibility for any equipment installed in violation of any codes and/or regulations.

NOTE: The instructions contained within this manual are intended as a general guide and do not supersede local or national code in any way. Authorities who have jurisdiction should be consulted before installation.

3.1.4 Replacement Parts

When reporting damages, shortages, or ordering replacement/repair parts, be sure to give the complete product model and serial numbers that are stamped on the product. Replacement parts for this product are available through your contractor or local distributor.

3.2 Location

WARNING

 ***DO NOT* install this coil outdoors. It is designed for indoor installation only.**

- The coil drain pan has a maximum service temperature of 500°F (260°C). Close spacing may damage the drain pan and cause a leak. Please refer to the Product Specifications for the proper use of these coils with specific furnaces, air handlers, condensers, and line sets.

3.2 Location (cont.)

When installing the coil take into consideration the length of the refrigerant piping and try to minimize the distance as much as possible. **DO NOT install the air handler in a location that is either above or below the condenser that violates any instructions/requirements of the condenser in the system it is being installed in (consult the manuals/information provided with the condenser).** Allow a minimum of 24 in (610 mm) in front of the unit to provide clearance for service. When installing in an area directly over a finished ceiling (such as in an attic), an emergency drain pan is required to be installed directly under the unit. Please refer to local and state codes for requirements. When this unit is installed in area that may become wet, elevate the unit with a sturdy, non-porous material. In installations that are in locations that may lead to physical damage (ex: garage), it is advised to install a protective barrier to prevent such damage.

3.3 A-Coil Orientation/Position Options

3.3.1 Installing A-Coils with a furnace

When installing the Universal A-Coils in an application with a furnace, it must be installed in a position where the return air flows through the furnace first and then the A-Coils. From the A-Coils, the airflow is then supplied to the ductwork to be dispersed throughout the rooms.

Downflow Application

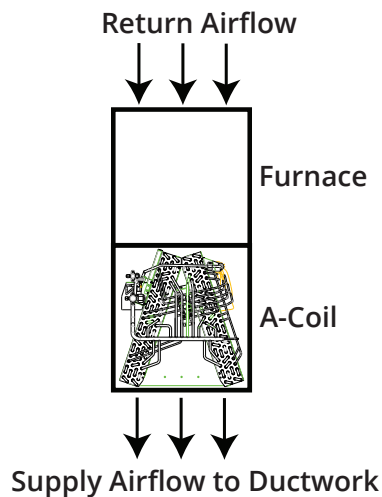

Upflow Application

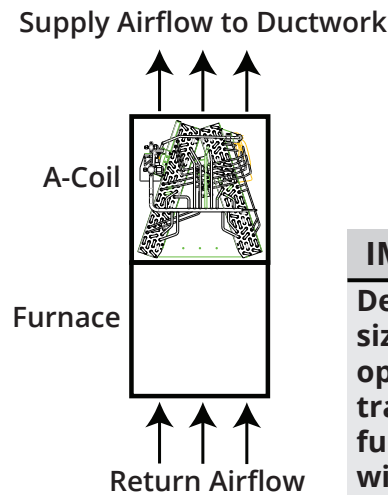

Horizontal Right Application

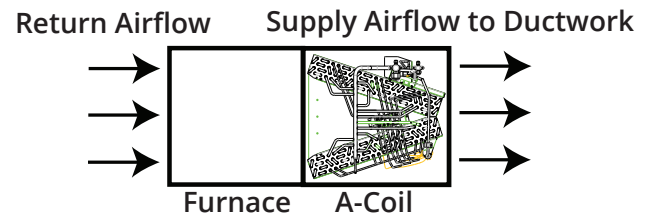

IMPORTANT:

Depending on your application (specifically the size of the components in your system, cabinet opening size and A-Coil opening size, etc.) a transition may need to be constructed so the furnace and A-Coil can be connected together with a smooth transition between openings.

3.3.2 Installing A-Coils with a modular blower

When installing the Universal A-Coils in an application with a modular blower, it must be installed in a position where the return air flows through the A-Coils first and then the modular blower. From the modular blower, the airflow is then supplied to the ductwork to be dispersed throughout the rooms.

Downflow Application

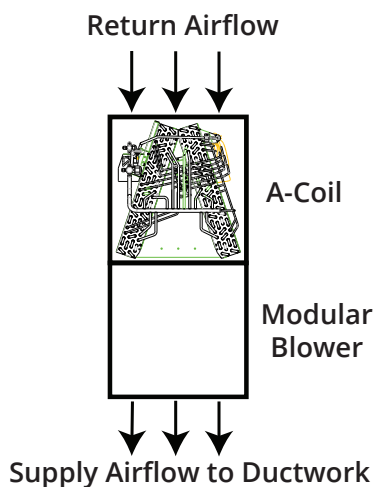

Upflow Application

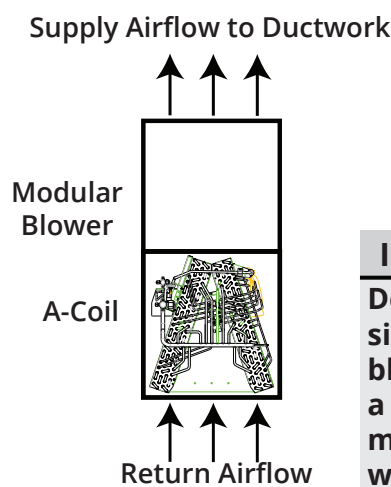

Horizontal Right Application

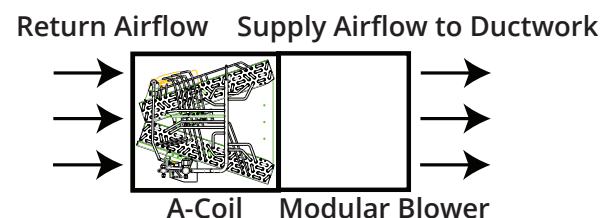

IMPORTANT:

Depending on your application (specifically the size of the components in the system, modular blower opening size and A-Coil opening size, etc.) a transition may need to be constructed so the modular blower and A-Coil can be connected with a smooth transition between openings.

3.4 Refrigerant Piping Connection

3.4.1 Specifications of Connection Pipe

Model	External diameter (inch)	
	Gas pipe	Liquid pipe
MDUCC15024/MDUCC15036	3/4 in	3/8 in
MDUCC15048/MDUCC15060		

3.4.2 Piping Preparation

NOTE: If you are installing your A-Coil with the optional MRCOOL® No-Vac® Quick-Connect® Line Set, please skip forward to the installation instructions for the line set on pg. 10. Once the line set installation is complete, continue to step 3.5 Condensate Removal and continue installation from there.

Solder Connection

If connecting piping with solder, make sure that any cuts made to the piping are round, burr free (use a reamer), cleaned, and at a perfect 90° angle. Make sure the line set size matches the service valve connector.

⚠ **DO NOT** crimp the service valve connector if the piping is of a smaller diameter.

Failure to follow these guidelines could result in refrigerant leaking from the piping. Refer to the illustrations below.

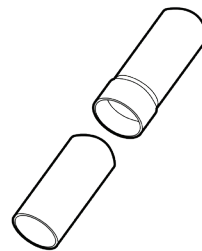
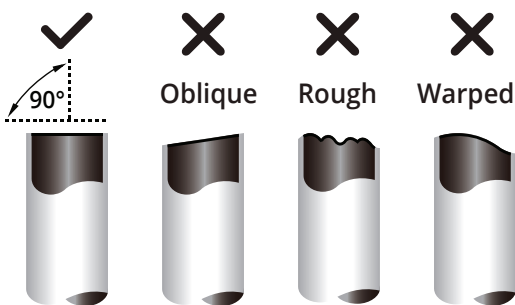

Line set size matches service valve connector



Do not crimp service valve connector when pipe is smaller than connector

⚠ IMPORTANT

In order to prevent the refrigerant piping from sweating you can insulate them with closed-cell insulation foam for refrigerant line sets which is readily available.

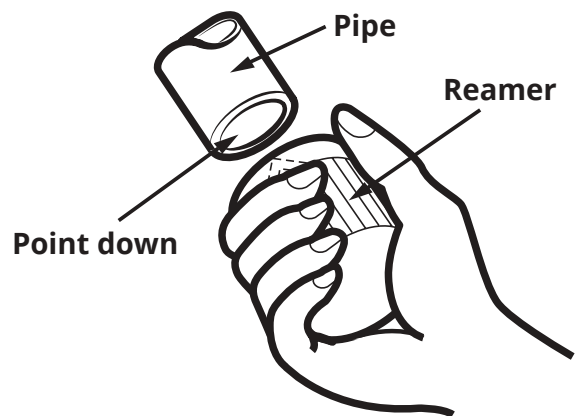
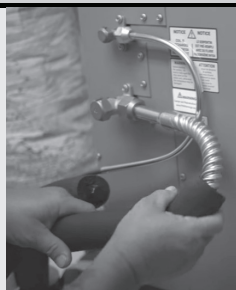

Unit Installation

Screw Connection

Connect the pipe to the unit. Follow all instructions below. Use both a spanner and torque wrench. When connecting the tapered flare nut, first apply Polyolester oil (POE oil) on its inner and outer surface. Then, screw the first 3 or 4 threads by hand. Next, tighten the nut with the spanner and torque wrench. Confirm the tightening torque by referring to the following table. Keep pipe connection exposed to perform the leak test.

⚠ **DO NOT over-tighten the nut as it could damage it and cause the connection to leak.**

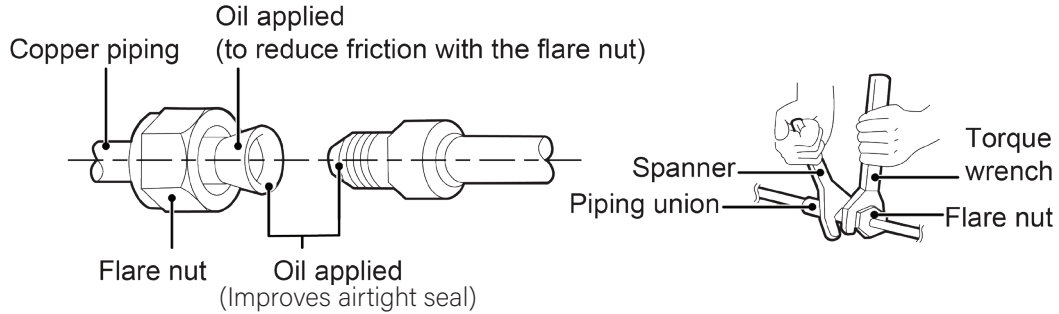

Pipe diameter (inch)	Tightening torque: ft-lbs (N·m)
1/4 in	11-22 ft-lbs (15-30 N·m)
3/8 in	26-30 ft-lbs (35-40 N·m)
1/2 in	33-37 ft-lbs (45-50 N·m)
5/8 in	44-48 ft-lbs (60-65 N·m)
3/4 in	52-55 ft-lbs (70-75 N·m)
7/8 in	59-63 ft-lbs (80-85 N·m)

No-Vac® Quick Connect® Line Set Installation

**INSTRUCTIONS FOR USE WITH NO-VAC™ QUICK CONNECT® LINE SET SOLD SEPARATELY
KINK RESISTANT, PRECHARGED, SIMPLE SECURE QUICK CONNECT, 100% CONNECTION GUARANTEE**

Please read and follow the instructions and diagram below* :

Connections must be made exactly as specified to avoid system leaks and /or damage

1. Take out matching male connectors **M1** and **M2**.
2. **Remove** protective cap with the copper gasket at each stop valve on the **DC INVERTER** and ensure the threads are clean and complete.
3. **Tighten** the **M1** connector to the **cutoff valve *1** with a tightening force of **37 ft/lb (50 Nm)**. **Tighten** the **M2** connector to the **cutoff valve *2** with a tightening force of **52 ft/lb (70.5 Nm)**.
4. **Repeat** step 3 for **AIR HANDLER** at the other end of the **LINE SET**.
5. Unroll and route the **LINE SET** between the **AIR HANDLER** and the **DC INVERTER**. Bend the line set by hand to route the line set to suit your application. Use care when bending the line set. Please refer to the **Bending the Line Set** section on **Pg. 11** for more detailed instructions on how to properly and safely bend refrigerant piping, as well as the correct bend radius.
6. **Remove** the protective caps of the valves at both ends of the **LINE SET**. Verify that all threads are clean and complete.
7. **Tighten** the **LINE SET F1** valve to the **M1 Connector** (attached in step 3) with a force of **33 ft/lb (45 Nm)**. **Tighten** the **LINE SET F2** valve to the **M2 Connector** (attached in step 3) with a tightening force of **48 ft/lb (65 Nm)**.
8. **Repeat** this process for the **AIR HANDLER** at the other end of the **LINE SET**.
9. At the **OUTDOOR UNIT** remove the **protective cap** at the **cutoff valve switch** and **open** the **cutoff valve** with a hex wrench to release refrigerant into the system. **If** there is any fizz, grease or other **leakage**, then **close** the valve **immediately** and **check** that **steps 3 and 7** were done properly. **Otherwise**, using a sponge or spray bottle, apply a soapy water solution to the connection points to check for micro leaks. **If any bubbles form** it indicates there is a leak. **If** this does occur, **close** the valve **immediately** and **check** that **steps 3 and 7** were done properly and re-tighten the valves and line set if necessary.
10. **After** the correct connection, **re-tighten** the cutoff valve's **protection cap** and **cover** the **M1, M2** and **F1, F2** connections with the gray **insulating sleeve** to help **prevent condensation**. Then, proceed to section **3.5 Condensate Removal** and continue the installation.

IMPORTANT

When running the Line Set through the knockout hole of the condenser, it may be necessary to slightly trim the line set insulation so it feeds through the hole freely. Otherwise, it may be difficult to connect it to the condenser. Once the installation is complete, pack the hole with neoprene to prevent small animals and insects from entering the condenser.



NOTE ON WRENCHES

The wrench sizes needed for tightening the No-Vac® Quick Connect® Line Set are listed below. However, based on the availability of the wrench sizes needed, it is recommended to use two large crescent (adjustable-type) wrenches. Using one to hold the valve while using the other wrench to tighten the line set connector.

Piping Size (Stamped on piping)	Wrench Size Required	
	Standard	Metric
3/8"	1"	25 mm
3/4"	1-3/8"	35 mm

Or 2x large crescent (adjustable-type) wrenches

Allen/Hex Wrench Sizes Needed To Open Stop/Cutoff Valves	
Piping/Valve Size (Stamped on piping)	Allen Wrench Size
3/8"	5 mm
3/4"	8 mm

IMPORTANT

The stop/cutoff valves on the unit must be opened **AFTER** connecting the lines and **BEFORE** turning on the unit. Otherwise, operation can cause leakage and/or damage to the unit.

Complete unit replacement using the No-Vac® Quick Connect® lines

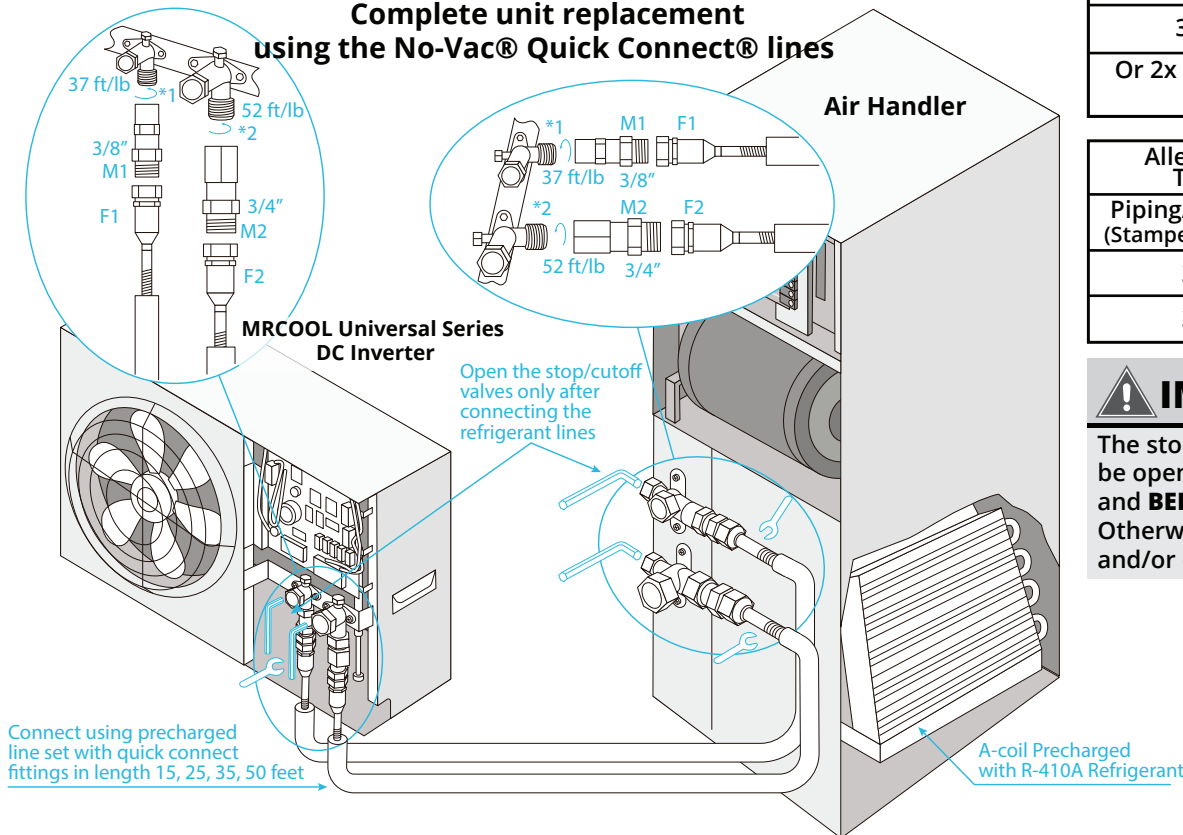

**Failure to follow the instructions provided could result in severe harm to you, this product, or other property. The manufacturer, distributor, and seller are not responsible for any harm resulting from the failure to follow instructions and the failure to follow these instructions will void any and all warranties express or implied.*

www.mrcool.com

v08-13-2021

Unit Installation

Bending Line Set

1. Use your hands to bend the line set. Work carefully not to collapse the pipes during bending.
2. If the pipe is repeatedly bent or extended, it will become hard and difficult to manipulate. Avoid bending or extending the pipe more than 3 times.

- ⊘ **DO NOT** bend the pipes in at an angle greater than 90°.
- ⊘ **DO NOT** bend the pipe excessively, otherwise it will break.

MINIMUM BEND RADIUS

When bending connective refrigerant piping, the minimum bending radius is 4 in (10 cm). Refer to the illustration below.

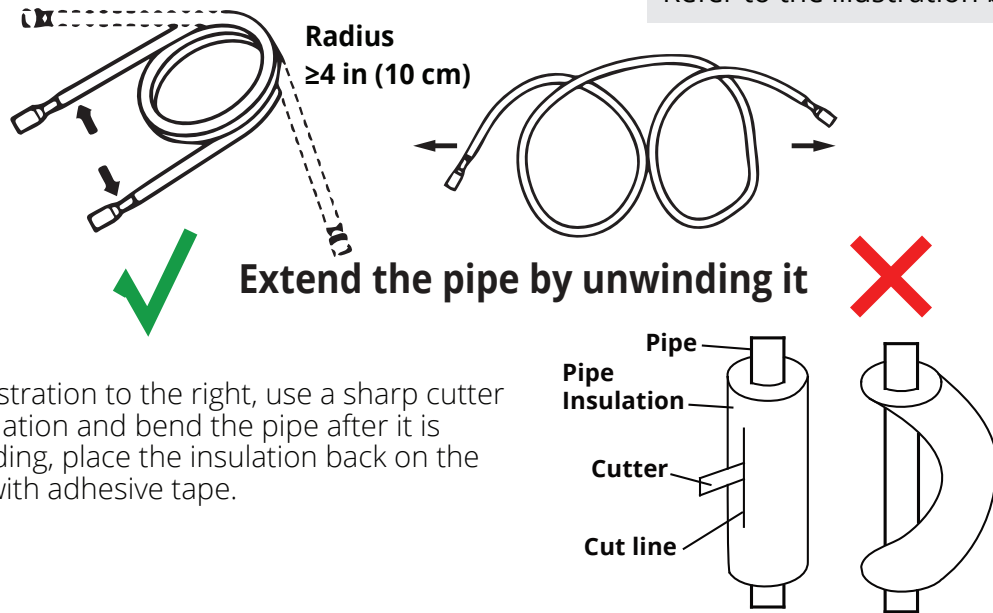

3. As shown in the illustration to the right, use a sharp cutter to cut the pipe insulation and bend the pipe after it is exposed. After bending, place the insulation back on the pipe and secure it with adhesive tape.

3.5 Condensate Removal

The drain pan has a primary and secondary drain connection. Condensate removal is performed by attaching a 3/4 in (19 mm) pipe to the evaporator coil drain pan and is terminated in accordance with local or state plumbing & HVAC codes. The installation must include a "P" style trap that is located close to the evaporator coil. Please refer to the guidelines and illustration below to best determine how and where to run the condensate drain pipe.

- ⊘ **DO NOT** over-tighten the drain connection as this could damage or distort the drain pan and cause condensate leakage.
- ⊘ **DO NOT** connect the condensate drain pipe into a waste pipe or other pipelines which are likely to produce corrosive fumes or an odor. Connecting to these pipes could cause the fumes or odor to enter indoors and/or corrupt the unit.
- ⊘ **DO NOT** connect the condensate drain pipe into a rain pipe, as this could cause rain water to enter the unit and cause property damage and/or personal injury.
- The condensate drain pipe should be connected into a drain system specifically for the unit.

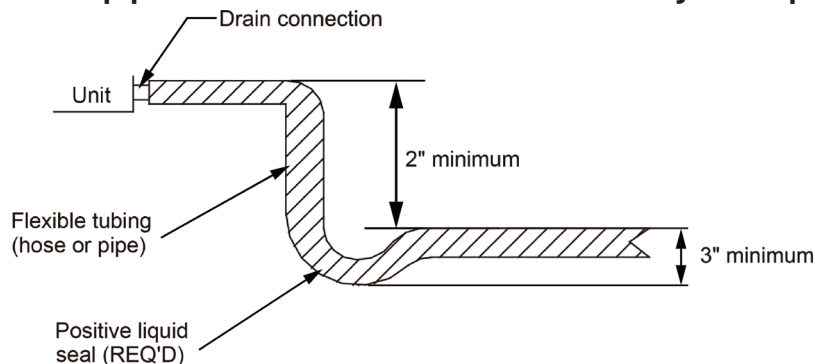

3.6 Ductwork

WARNING

- ⊘ ***DO NOT*** operate the unit without all of the ductwork completed and installed.
- ⊘ ***DO NOT*** operate this product without all of the ductwork attached.

This coil is designed for a complete supply and return ductwork system. Inadequate ductwork, that restricts airflow, can affect performance and can lead to compressor or heater failure. Ductwork should be constructed in a manner that limits restrictions and has the ability to maintain suitable air velocity. The ductwork should be sealed to the unit in order to prevent leakage. The ductwork should also follow the guidelines below in regards to the return ductwork and return air filter arrangement.

- **Return Ductwork:**
 - ⊘ ***DO NOT*** terminate the return ductwork in an area that can introduce toxic or objectionable fumes/odors into the ductwork. These will be introduced into the coil and dispersed throughout the ductwork into the indoor areas.
- **Return Air Filters:** Each installation must include a return air filter. This filter may be located at the coil, or externally with a return air filter grill.

3.7 Unit Installation

The furnace, air handler, and condensing unit should be installed according to the installation instructions provided with those units before the coil can be installed. Position the cased coil on top of the furnace or air handler cabinet and secure it using field-provided screws.

NOTE: If the coil is to be installed on an oil furnace, it may be necessary to have a field-installed transition between the furnace and the coil to prevent an airflow restriction and possible damage to the coil drain pan. Please refer to the oil furnace installation instructions for further details.

3.8 Sealing Ducts

WARNING

- There must be an airtight seal between the bottom of the furnace and the return air plenum. Use fiberglass sealing strips, caulking, or an equivalent sealing method between the plenum and the air handler cabinet to ensure a tight seal.
- ⊘ ***DO NOT*** allow the return air to be drawn from a room where the air handler, any gas-fueled appliance (ex: water heater), or carbon monoxide-producing device (ex: wood fireplace) is installed.

Ensure that the duct is secured and all joints are properly sealed to the coil cabinet flanges. All indoor cabinets **MUST** be taped after installation to seal against any air leaks. System performance and efficiency will be reduced if any leaks are present.

3.9 Leak Testing, Evacuating, and Charging

Refer to the outdoor unit installation instructions for leak testing, evacuating, and charging procedures. Always check the entire system for leaks before charging it.

Proper air volume must be provided over the evaporator coil. Select a blower motor speed that will provide 300-450 CFM per 12,000 Btu/h of cooling capacity (wet coil). Refer to the **Table 1** below for the recommended airflow volume.

Table 1

Cabinet		Recommended Volume (CFM)
Model	Width inch (millimeter)	
MDUCC15024/ MDUCC15036	17.5 (444.5)	800
	17.5 (444.5)	1000
MDUCC15048/ MDUCC15060	24.5 (622.3)	1230
	24.5 (622.3)	1510

Regular checks of the system, maintenance, and care should only be performed by qualified, professional personnel in order to prolong the life of the unit.

5.1 Condensate Drain Pipe

Regularly check to make sure the drain pipe is not clogged and condensate drains smoothly. A clogged condensate pipe can cause the drain pan to overflow with condensate which can lead to property damage.

5.2 Checklist Before Seasonal Use

- Check the inlet and outlet of indoor units for clogs.
- Check that the filter screen is securely installed in place.
- Check that unit is securely installed in place.

NOTE: If you notice something abnormal during this check, please contact the local appointed service center, or MRCOOL® Technical Support at (270) 366-0457.

5.3 Maintenance After Seasonal Use

- Clean dust, debris, and contaminants off of the indoor unit.
- In the event rust has started to form, apply anti-rust paint to stop it from continuing to spread.

5.4 Parts Replacement

Only purchase replacement parts from a locally appointed service center or dealer if necessary.

In the event you have any issues with the quality of the unit you purchased, or just have an inquiry, please contact the after-sales service agency designated by MRCOOL®.

****Warranty claims should meet the following requirements:****

- Installation, initial startup, and first run of the unit should only be performed by professional personnel from a MRCOOL® appointed service center. The services of a professional are **NOT** required when the MRCOOL® Quick Connect® Pre-Charged Line Set is used for the installation.
- Only factory manufactured accessories can be used on the unit.
- Installation should be performed by following the instructions provided in this manual.

****Warranty automatically becomes invalid if any of these requirements are not met.****



MIRCOOL®

COMFORT MADE SIMPLE

UNIVERSAL A-Coils

The design and specifications of this product and/or manual are subject to change without prior notice. Consult with the sales agency or manufacturer for details.