

# INSTALLATION AND MAINTENANCE



Smart Heating Solutions

## LPW-ECO 2-Stage Electronic Heater With Remote Control and Remote Sensor



Remote



Remote Sensor

Figure 1-1

Covers all LPW-ECO models

DANGER

ELECTRIC SHOCK OR FIRE HAZARD

READ ALL WIRE SIZING, VOLTAGE REQUIREMENTS AND SAFETY DATA TO AVOID PROPERTY DAMAGE AND PERSONAL INJURY

WARNING

**READ CAREFULLY** - Use the heater only as described in this manual. Any other use is not recommended and could result in fire, electric shock, and personal injury. Following these instructions will prevent difficulties that might occur during the installation and use of the heater. Please study the instructions first, as they may save considerable time and trouble during use addition to providing important safety information. Make sure to save these instructions for future use.

- WARNING** 1. Read all instructions before wiring or using this heater.
- WARNING** 2. This heater is hot when in use. To avoid burns, do not let bare skin touch hot surfaces. Keep combustible materials, such as furniture, pillows, bedding, papers, clothes, boxes, etc., and curtains must be at least 3 feet away from the front and sides of heater.
- WARNING** 3. Extreme caution is necessary when any heater is used by or near children or invalids and whenever the heater is left operating and unattended.
- WARNING** 4. Do not operate any heater after it malfunctions. Disconnect power at service panel and have heater inspected by a qualified electrician for repair before reusing.
- WARNING** 5. Do not use outdoors.
- WARNING** 6. To disconnect heater, turn controls to OFF, and turn OFF power from main service panel.
- WARNING** 7. Do not insert or allow foreign objects to enter any ventilation or exhaust opening as this may cause an electric shock, fire, or damage to the heater.
- WARNING** 8. To prevent a possible of fire, do not block air intakes or exhaust in any manner.
- WARNING** 9. A heater has hot and arching or sparking parts inside. Do not use it in areas where gasoline, paint, or any other flammable vapors or liquids are stored.
- WARNING** 10. Use this heater only as described in the manual. Any other use is not recommended by the manufacturer and may cause fire, electric shock, explosion or injury to people and or property.
- WARNING** 11. This heater includes a Smart limit protection that shuts down heater in the event of excessive over heating.

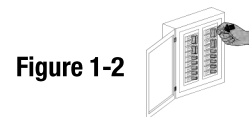

Figure 1-2

# LPW INSTALLATION INSTRUCTIONS

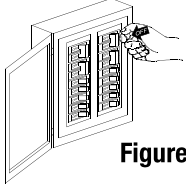

Figure 2-1

**CAUTION!**  
Turn OFF all electrical power to install heater

DANGER

**ELECTRIC SHOCK OR FIRE HAZARD**

READ ALL WIRE SIZING, VOLTAGE REQUIREMENTS AND SAFETY DATA TO AVOID PROPERTY DAMAGE AND PERSONAL INJURY

Figure 2-2

Rating Label Location

ALL WARRANTIES ARE VOID IF THIS HEATER IS USED WITHOUT OBSERVING THE INSTRUCTIONS.  
**King Electrical Mfg. Seattle Wa.** LISTED  
 Do Not Install Less Than 8" From Vertical Side Walls. Install Bottom Of Heater Not Less Than 8" Above The Finished Floor. The Electrical Power To The Heater Is To Be Disconnected Before The Grill Is Removed For Cleaning. Do Not Operate The Heater With Grill Removed. For Use With Vertical LP/PROPANE. Installer Le Partie Inferieure Du Radiateur Au Moins A 100mm Au-dessus Du Plancher Fini. Installer Le Partie Supérieure Le Partie 182mm Lors De Montage Vertical. Installer Le Partie Inferieure Du Radiateur Au Moins A 100mm Au-dessus Du Plancher Fini.  
**MODEL: LPW724ET WATTS:4000 VOLTS: 277**  
 SINGLE MAXIMUM WATTS THIS HEATER IS WIRED FOR  
 277 VOLT:4000-3000-2000-1000  
 MADE IN U.S.A



Figure 2-3

## INSTALLATION LOCATION AND CLEARANCES

### Selecting a location for your heater:

Do Not install less than 6 inches from vertical side walls or open edge of door. Unit cannot be installed greater than 2' off the floor. This heater must have an unrestricted airflow. Do Not select a location where it is likely to be blocked by furniture, curtains, etc. Be sure the location selected allows sufficient space for the heater as shown below by Table 1. Do Not locate this heater in an area where combustible vapors, gases, flammable liquids, or excessive lint, dust or moisture is present.

Table 1

Minimum Clearances for heater:			
Front	TOP	BOTTOM	SIDES
36 in	12 in	4 in	6 in
0.9 m	30.5 cm	10.2 cm	15.2 cm

Zero clearance to insulation.

The wire and breaker sizing chart will give a general rule of installation size. Consult an electrician if you are not knowledgeable about wiring codes.

### Wire and Breaker Sizing:

#### WIRING: Branch Circuit Connection

Table 2

Total Amps	Minimum AWG. Wire Size (Copper)	Circuit Breaker or Fuse Size
0 thru 12	#14	15 amp
12.1 thru 16	#12	20 amp
16.1 thru 24	#10	30 amp

### Product Dimensions

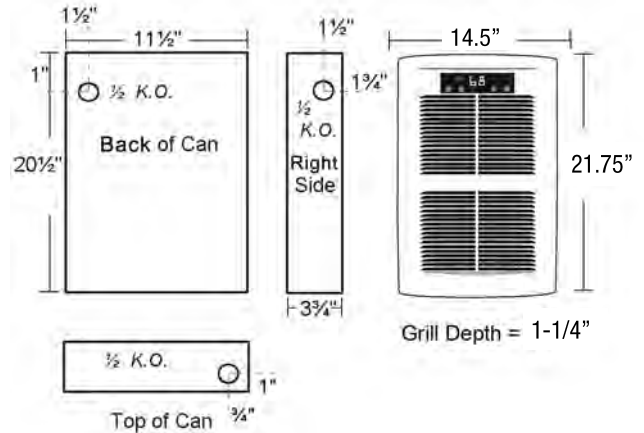

# WATTAGE SELECTION

**Model: LPW2045-ECO (208V 4500W Max)**

**Model: LPW2445-ECO (240V 4500W Max)**

The heater is factory wired to 4500 Total Watts at 208/240 Volts (4500 Watts Stage 1 - HIGH / 2750 Watts Stage 2 - ECO). To change the heater's Stage 1 and State 2 wattages, unplug insulated push-on terminals from the elements per the chart below and wrap with electrical tape to prevent possibility of electrical contact with element & other parts.

<b>Element # 1</b>	<b>Red Wire</b>	Disconnects 1000 Watts
	<b>Blue Wire</b>	Disconnects 750 Watts
	<b>Orange Wire</b>	Disconnects 500 Watts
<b>Element # 2</b>	<b>Black Wire</b>	DO NOT DISCONNECT (Common)
	<b>Purple Wire</b>	Disconnects 1000 Watts
	<b>Yellow Wire</b>	Disconnects 750 Watts
	<b>Brown Wire</b>	Disconnects 500 Watts
	<b>Black Wire</b>	DO NOT DISCONNECT (Common)

END VIEW OF ELEMENT #1

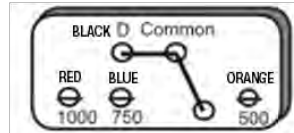

END VIEW OF ELEMENT #2

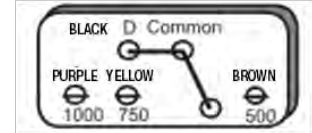

HEATING STAGES		ELEMENT TERMINATIONS			
		CONNECT		DISCONNECT	
STAGE 1 - HIGH HEAT	STAGE 2 - ECO	Element #1	Element #2	Element #1	Element #2
4500 Watts	2750 Watts	RED + BLUE + ORANGE	PURPLE + YELLOW + BROWN	-	-
4000 Watts	2250 Watts	RED + BLUE	PURPLE + YELLOW + BROWN	ORANGE	-
3500 Watts	2700 Watts	RED + BLUE + ORANGE	YELLOW + BROWN	-	PURPLE
3000 Watts	2250 Watts	RED + BLUE	YELLOW + BROWN	ORANGE	PURPLE
2500 Watts	1750 Watts	BLUE + ORANGE	YELLOW + BROWN	RED	PURPLE

**Model LPW1227-ECO (120V 2750W Max)**

The heater is factory wired to 2750 Total Watts at 120 Volts (2750 Watts Stage 1 - HIGH / 1500 Watts Stage 2 - ECO). To change the heater's Stage 1 and State 2 wattages, unplug insulated push-on terminals from the elements per the chart below and wrap with electrical tape to prevent possibility of electrical contact with element & other parts.

<b>Element # 1</b>	<b>Red Wire</b>	Disconnects 750 Watts
	<b>Blue Wire</b>	Disconnects 500 Watts
	<b>Orange Wire</b>	Disconnects 250 Watts
	<b>Black Wire</b>	DO NOT DISCONNECT (Common)
<b>Element # 2</b>	<b>Purple Wire</b>	Disconnects 750 Watts
	<b>Yellow Wire</b>	Disconnects 500 Watts
	<b>Brown Wire</b>	Disconnects 250 Watts
	<b>Black Wire</b>	DO NOT DISCONNECT (Common)

END VIEW OF ELEMENT #1

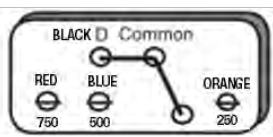

END VIEW OF ELEMENT #2

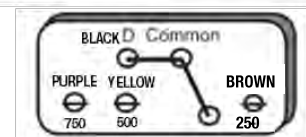

HEATING STAGES		ELEMENT TERMINATIONS			
		CONNECT		DISCONNECT	
STAGE 1 - HIGH HEAT	STAGE 2 - ECO	Element #1	Element #2	Element #1	Element #2
2750 Watts	1500 Watts	RED + BLUE + ORANGE	PURPLE + YELLOW	-	-
2500 Watts	1750 Watts	RED + ORANGE	PURPLE + YELLOW + BROWN	Blue	-
2250 Watts	1500 Watts	RED	PURPLE + YELLOW + BROWN	BLUE + ORANGE	-
2000 Watts	750 Watts	RED + BLUE	YELLOW + BROWN	ORANGE	PURPLE
1750 Watts	1250 Watts	RED + BLUE	YELLOW	ORANGE	PURPLE + BROWN
1500 Watts	1000 Watts	BLUE + ORANGE	YELLOW + BROWN	RED	PURPLE

# SETUP OF REMOTE TEMPERATURE SENSOR

A wireless temperature sensor is provided to monitor the ambient temperature from any remote location. It needs to be paired with the heater and will transmit real-time temperature to the heater for highly accurate room temperature control.

## Sensor Placement

Important: Avoid areas that can have temperature extremes, making the sensor think the room is cooler or warmer than it actually is. Don't install the sensor near doors that could let in drafts, or on exterior walls or near windows in direct sunlight.

## ECO2S REMOTE SENSOR:

**IMPORTANT:** The remote sensor must be paired to the heater prior to use. If display shows "L5" the sensor has not been paired successfully. Repeat Pairing Process

**Technical Specifications:**  
 Protocol: Wireless 2.4G  
 Transmit Distance: 98'  
 Working Voltage: DC 3V (battery);  
 Detecting Temperature: 0° to 99°F

## Product Overview

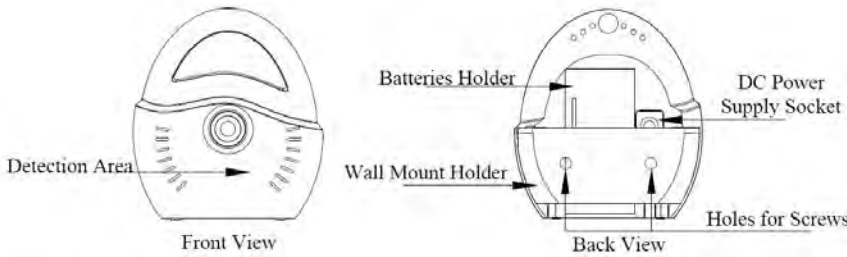

## ECO2S+ Control Panel

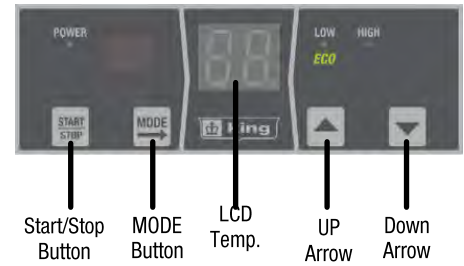

## Pairing and Installation Guide

Since it is possible that more than one heater/sensor would be used in a home, you must first pair the remote sensor to a specific heater. Each remote sensor has a unique ID number, which will be used in the pairing process. When installing the remote sensor first time, users need to pair the remote sensor with LPW heater, so the heater can learn and save the remote sensor's ID.

**Step 1:** First, power off the remote sensor (remove the battery or unplug the adapter).

**Step 2:** On the Heater's Display Press **START STOP** and **DOWN** button at the same time for 5 seconds. The LED display will flash "id".

**Step 3:** Release buttons, put the remote sensor within 3 feet of the heater and power on the remote sensor again. The green LED light in the remote sensor will flash, and LPW the controller display indicator lights will illuminate (LED tubes show 88) for 1 second and then turn off. This means the remote sensor and the controller have paired with each other successfully.

**NOTE:** If the LPW display flashes "id" for 20 seconds and then turns off, it means that the heater failed to pair with the remote sensor and has exited the Pair mode. Repeat the above steps to pair the remote sensor.

**Step 4:** After pairing the remote sensor successfully, put the sensor in the room where you want to detect temperature. The LPW heater display will now display the temperature from the remote sensor.

## Installing Batteries

Open the battery cover and insert 2pcs AAA batteries, reinstall the battery cover.

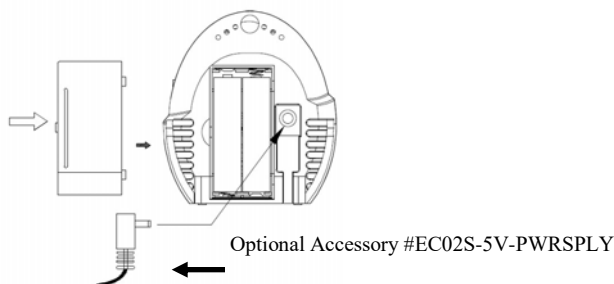

## Mounting The Remote Sensor

Sensor can be placed on any flat surface or can be fixed to the wall with the mounting bracket. **Mounting Bracket Install:** Select location for the sensor on the wall, Secure the bracket to with 2 appropriate anchors and screws. Insert remote sensor into bracket.

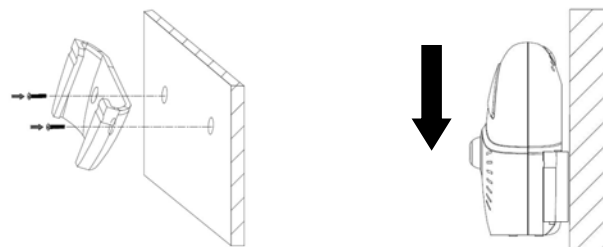

## Low Battery Indicator

When batteries are low, "BA" will flash on the ECO2S+ heater display to indicate batteries should be replaced. **Note:** If batteries fail, the ECO2S+ is designed to revert back to the onboard temperature sensor for temperature control until the batteries are replaced in the remote sensor.

## Low Signal Indicator

When the sensor is not paired with the heater or if the signal is being blocked, the display flashes "LS". After 10 minutes, the controller will automatically switch to work with the on-board temperature sensor, but the display will continue to flash "LS" until the signal restored.

1. Following Pairing process above to successfully pair the sensor.
2. Move Sensor closer to the heater or away from metal objects that might block the signal.

# WIRING AND INSTALLATION

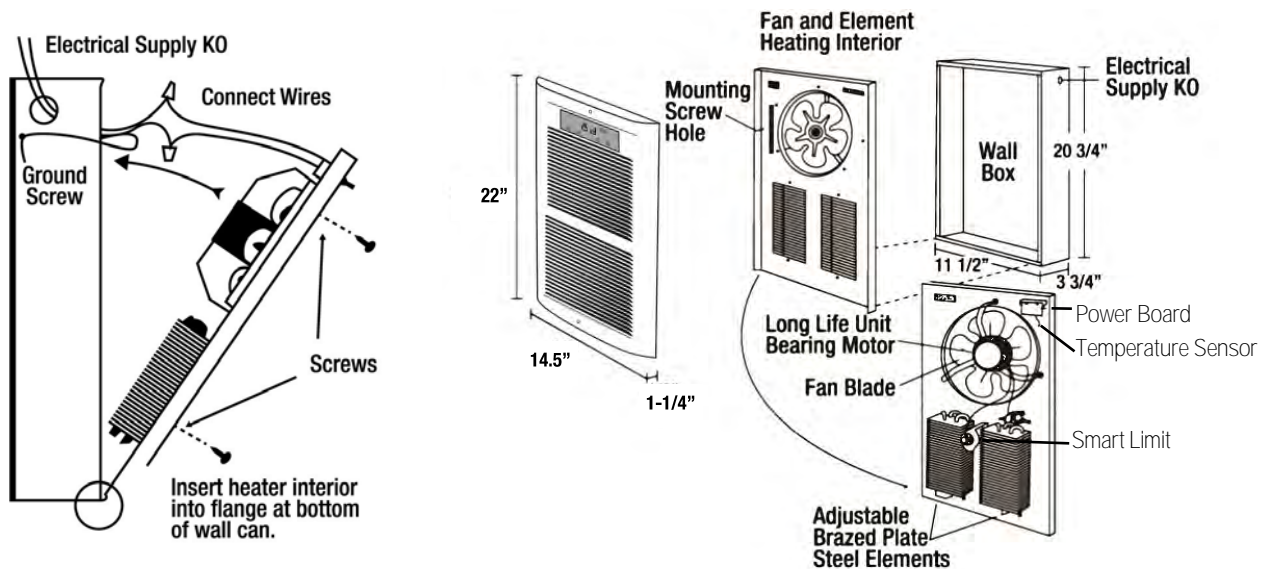

1. Connect heater only to the voltage, amperage and frequency specified on the nameplate.
2. Wiring procedures and connections shall be in accordance with all National and local codes having jurisdiction.
3. Set the bag containing the grill and packet with (2) grill screws aside.
4. Loosen grill screws and as you slowly remove grill disconnect the quick connectors on the LCD patch cable so grill can be completely removed from heater.
5. Loosen interior fan heater assembly mounting screws (4) and remove fan heater assembly.
6. A knockout of 1/2 inch conduit size (7/8 inch) is provided in the back and side of the heater for power to enter. Provide proper strain relief connectors (not included) for your wire entering the wall box.
7. Install wall box a minimum of 6 inches from vertical side walls and 4 inches above floor.
8. Secure wall box to the 2 x 4 studs using the (2) holes on the side of the wall box. Secure to wall stud on opposite side if required.
9. Make final High and Low wattage selections. See page 3 for details.
10. Connect supply wires, attach ground feed wire to the green ground wire with wire nuts.
11. Reinstall heater assembly into wall box with screws (4).
12. Reinstall grill following the opposite steps of removal. Connect LCD display patch cable by securing quick connectors together and secure grill with provided screws. Do Not over tighten.
13. Test unit by turning thermostat up past room temperature. You will see a puff of smoke as the elements are energized and the fan turns on. This is a normal burn off of manufacturing lubricants and will dissipate in 5 minutes.
14. For full operating details refer to Operating Instructions on page 6.



# ECO2S OPERATING INSTRUCTIONS



## Electronic Controller Features:



- 2-Stage Heating that automatically uses the low-est wattage needed to heat the room
- Remote Temperature Sensor For Accuracy
- Remote Control and Wall Bracket Included
- Thermostat timer mode (1-9 Hours)
- Energy-saving automatic 2-stage heating
- Fan only mode
- Large LED display
- Built-In fan delay
- Display Lock Feature
- Bedroom or Standard “Environment” Models

## OPERATING INSTRUCTIONS

### Operation



1. Push the  button, the heater will come on and heat to the default setting of 72°F.
2. Once the room temperature reaches the set point, the heat elements will turn off followed by a 3 minute fan delay period to exhaust excess heat from the case. Afterwards the unit will turn off.
3. In normal operation the display will show the current room temperature.

### Automatic 2-stage HIGH/LOW operation



Eco2S controller offers energy efficient 2-stage heating, automatically using the lowest wattage required to heat the room.

- During operation, when the set temperature is within 3 degrees of the room temperature the heater automatically switches to ECO mode, operating at LOW wattage.

### Room Temperature Selection

- During operation, push  or  arrow buttons to set the temperature from 40°F-95°F, Hold down the UP or DOWN arrow to speed up the selection process. The LCD will go back to display room temperature after 5 seconds.



### Timer Mode Selection

- During operation, press the  button 1 time, the display window will show the timer mode setup. Push  or  to set Timer from 0 hour - 9 hours. (0H-9H).

In timer mode the heater operates based on the thermostat's set point. Once the timer period expires, the heater will then be permanently off.

### Fan Only Mode Selection

- During operation, press the  button 2 times, the display window will show [ H ] (Heat Mode) or [ F ] (Fan Only Mode).

Push  or  to switch between Fan Only and Heat modes.

### Control Panel

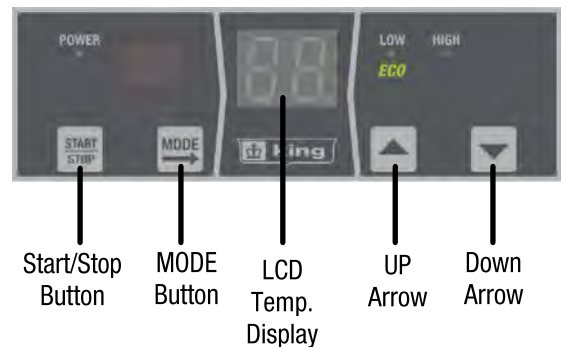

# OPERATING INSTRUCTIONS CONTINUED





## Display Lock Feature

Display Lock is designed for high traffic areas and deactivates the heater display buttons to prevent unwanted temperature adjustments. However settings can still be adjusted through the remote control.



- During operation, press the  button and HOLD for 5 seconds to set the display lock. [ L ] will appear on the display temporarily if a user attempts to make a temperature adjustment.
- While in Display Lock, heater can be adjusted using remote control.

## Setting “Environment” Mode

Two Environment Options: Standard [ SF ] and Bedroom [ BE ]. Bedroom Mode turns off the display after 30 seconds for people using this heater in a bedroom environment. Once any button is pressed the display turns back on.

- During operation, press the  and  buttons for 3 seconds. Then press  or  to select “Bedroom Mode” [ BE ] or “Standard Mode” [ SF ]

## Factory Reset





- During operation, press the  and HOLD the  button for 5 seconds to reset to the factory settings. [ FA ] will flash on the display once done.

## Sensor Error Code

- During operation, if the display shows [ E1 ] that indicates an issue with the sensor and the sensor needs to be replaced. Contact customer support for assistance.

## Setting Differential Value

The differential or gap affects how often the heater cycles. The lower the differential setting, the more the heater will cycle. If heater cycles too often, raise the differential setting to a higher degree.

- Press the  and  buttons for 5 seconds. The display will show the previously set differential. Press  or  to adjust the differential value between -0 to -5.

Control Panel

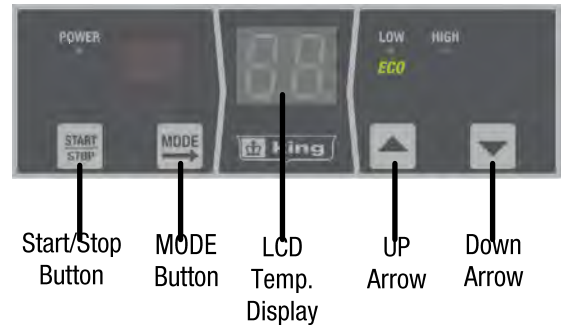

# SMART LIMIT PROTECTION



This heater is equipped with a thermal overload Smart Limit Protection which disconnects elements and motor in the event normal operating temperatures are exceeded. If thermal overload trips due to abnormal operating temperatures, thermal overload shall remain open until manually reset by turning the heater OFF for fifteen minutes. Inspect for any objects on or adjacent to the heater that may cause high temperatures. After inspecting the heater, keep the power to the heater off for 10 minutes to reset the SLP thermal protector. If the SLP thermal protector shuts the heater off again, immediately turn the heater OFF at the circuit breaker and inspect the heater for possible fan motor failure or dirt and lint on the heating element. Repeat the starting procedure. **DO NOT TAMPER OR REMOVE THIS THIS DEVICE.**

# GUIDELINES & MAINTENANCE

## General information and guidelines:

This heater must be properly installed before it is used. DO NOT tamper with or change the operating of this heater.

1. This heater must be properly installed in accordance with the National Electrical Codes (NEC) & local electrical codes before it is used.
2. After the electric heater has been completely installed, all thermostats should be turned to OFF. Turn ON breakers, wait 3 to 5 minutes. Check to see that all heaters are operating. Should any not be operating, disconnect power and check wiring.
3. Allow entire system to operate steadily for 1/2 hour. This should remove oily residue from manufacturing. (Some smoking may occur).

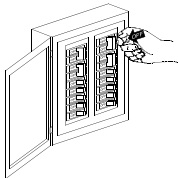

**Maintenance & Cleaning:** Basic maintenance is listed below and should be performed annually. When necessary, any required servicing should be performed by qualified service personnel. Your heater will give you years of service and comfort with only minimum care. To assure efficient operation follow the simple instructions below.

**WARNING:** Turn the electrical power OFF at the electrical panel board (circuit breaker or fuse box) and lock or tag this panel board door to prevent someone from turning on power while you are working on this heater. Failure to do so could result in serious electrical shock, burns, or possible death.

1. Before removing grill, turn the electrical power OFF and elements to cool. Circuit breakers are often not marked correctly and turning the wrong breaker off could mean electricity is flowing to the heater, even if the heater does not appear to be working. If you are uncomfortable working with electrical appliances, unable to follow these guidelines, or do not have the necessary equipment, consult a qualified electrician. Once you verify the power is off completely and element is cool, proceed to the next step.
2. Remove screws and take off grill. Wash grille with hot soapy water and dry immediately
3. Using a hair dryer or vacuum on blow cycle, blow debris back through the element. Do not touch element. Vacuum or use a soft brush and remove loose debris without touching the elements. The fan motor does not require lubrication.
4. Re-attach grill and secure with screws.
5. Turn thermostat to desired setting.

**WARNING:** All other servicing should be performed by authorized service personnel.

# TROUBLESHOOTING

Table 3

SYMPTOM	PROBLEM	SOLUTION
Breaker Trips	<ol style="list-style-type: none"> <li>1. Short Circuit</li> <li>2. Overloaded Circuit</li> <li>3. Improper Voltage</li> </ol>	<ol style="list-style-type: none"> <li>1. Find source of short. Trace heater circuit and verify the heater is wire properly.</li> <li>2. Reduce wattage in circuit. Refer to circuit sizing table for maximum wattage.</li> <li>3. Verify the heater voltage matches the supply voltage.</li> </ol>
Heater not working	<ol style="list-style-type: none"> <li>1. No Power</li> <li>2. Loose Connections</li> <li>3. Defective Limit</li> </ol>	<ol style="list-style-type: none"> <li>1. Turn Breaker ON, turn thermostat ON, check that the breaker is position properly on panel bus-bar. A 2-Pole breaker must be connected to both bus-bars (A &amp; B phase) to produce 240V power.</li> <li>2. Tighten wire connections.</li> <li>3. By-pass the limit to test. If heater works, replace the limit</li> </ol>
Heater Smokes	<ol style="list-style-type: none"> <li>1. Oil on element</li> <li>2. Needs Cleaning</li> </ol>	<ol style="list-style-type: none"> <li>1. It is normal for the element to burn off some light finishing oil used in the manufacturing process when first energized. Open windows and allow room to vent until it stops, usually within a few minutes.</li> <li>2. Remove any dust or dirt accumulations.</li> </ol>
Room Temperature does not match thermostat setting.	<ol style="list-style-type: none"> <li>1. Thermostat affected by another heat source.</li> </ol>	<ol style="list-style-type: none"> <li>1. Sunlight or other heat sources can affect the thermostat. Move the thermostat to another location or remove the heat source.</li> </ol>



## WARRANTY INFORMATION

King Electrical Manufacturing Company will repair or replace, without charge to the original owner, any LPW Series heater found to be defective or malfunctioning within 5 years of installation. This warranty requires the owner or his agent install the equipment in accordance with the National Electrical Code, any other applicable heating or electrical codes, and the manufacturer's installation instructions. It further requires that reasonable and necessary maintenance be performed on the unit. Failure to properly maintain the unit will result in the warranty being voided. The company is not liable for abuse or misuse of product as may be finally determined by the company. The customer shall be responsible for all costs incurred in the removal or reinstallation of products, including labor costs and shipping costs incurred to return products to King Manufacturing. King Manufacturing will repair or replace, at our option, at no charge to the customer with return freight paid by King. King Manufacturing shall not be liable for consequential damages arising with respect to the product, whether based upon negligence, tort, strict liability or contract. No other written or oral warranty applies, nor any warranties by representatives dealers, employees of King, or any other person. All returns require a King Return Goods Authorization (RGA); Unauthorized returns will be refused. Do not return malfunctioning/defective products to store.

**DO NOT RETURN PRODUCT**  
Are you experiencing difficulties?  
**We're Here to Help!**  
Call Us Toll Free at:  
**1-800-603-5464**  
(Select Option 2 from the Menu)  
7:00 am -3:30 pm PST Mon-Fri  
Or email us at [tech@king-electric.com](mailto:tech@king-electric.com)  
**Please have the following information available:**  
✓ Supply Voltage ✓ Heater Model Number  
✓ Remote or Inbuilt Thermostat? ✓ Date of Installation



Smart Heating Solutions