

# INSTALLATION AND MAINTENANCE



## LPWC Ceiling Heaters



**Models:**  
 LPW1227C-W  
 LPW2040C-W  
 LPW2445C-W  
 LPW2740C-W

DANGER

**ELECTRIC SHOCK OR FIRE HAZARD**

READ ALL WIRE SIZING, VOLTAGE REQUIREMENTS AND SAFETY DATA TO AVOID PROPERTY DAMAGE AND PERSONAL INJURY

Figure 1-1



WARNING

**READ CAREFULLY** - Use the heater only as described in this manual. Any other use is not recommended and could result in fire, electric shock, and personal injury. Following these instructions will prevent difficulties that might occur during the installation and use of the heater. Please study the instructions first, as they may save considerable time and trouble during use addition to providing important safety information. Make sure to save these instructions for future use.

- WARNING 1.** Power must come to heater first.
- WARNING 2.** Read all instructions before wiring or using this heater.
- WARNING 3.** This heater is hot when in use. To avoid burns, do not let bare skin touch hot surfaces. Keep combustible materials, such as furniture, pillows, bedding, papers, clothes, boxes, etc., and curtains must be at least 3 feet away from the front and sides of heater.
- WARNING 4.** Extreme caution is necessary when any heater is used by or near children or invalids and whenever the heater is left operating and unattended.
- WARNING 5.** Do not operate any heater after it malfunctions. Disconnect power at service panel and have heater inspected by a qualified electrician for repair before reusing.
- WARNING 6.** Do not use outdoors.
- WARNING 7.** To disconnect heater, turn controls to OFF, and turn OFF power from main service panel.
- WARNING 8.** Do not insert or allow foreign objects to enter any ventilation or exhaust opening as this may cause an electric shock, fire, or damage to the heater.
- WARNING 9.** To prevent the possibility of fire, do not block air intakes or exhaust in any manner.
- WARNING 10.** A heater has hot and arching or sparking parts inside. Do not use it in areas where gasoline, paint, or any other flammable vapors or liquids are stored.
- WARNING 11.** Use this heater only as described in the manual. Any other use is not recommended by the manufacturer and may cause fire, electric shock, an explosion, injury or death to people and or property.
- WARNING 12.** This heater includes Smart limit protection that shuts down heater in the event of excessive over heating. To reset heater turn OFF power wait 15 minutes for limit to reset & turn power back ON.



Figure 1-2

# LPW INSTALLATION INSTRUCTIONS

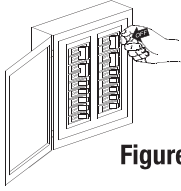

**CAUTION!**  
Turn OFF all electrical power to install heater

Figure 2-1

Rating Label Location



Figure 2-3

DANGER

ELECTRIC SHOCK OR FIRE HAZARD

READ ALL WIRE SIZING, VOLTAGE REQUIREMENTS AND SAFETY DATA TO AVOID PROPERTY DAMAGE AND PERSONAL INJURY

Figure 2-2

ALL WARRANTIES ARE VOID IF THIS HEATER IS USED DURING CONSTRUCTION FOR HEATING  
**King Electrical Mfg. Seattle Wa.** LISTED FOR HEATER  
 Do Not Install Less Than 6" From Vertical Side Walls. Install Bottom Of Heater Not Less Than 4" Above The Finished Floor. The Electrical Power To The Heater Is To Be Disconnected Before The Grill Is Removed For Cleaning. Do Not Operate The Heater With Grill Removed. For Use With Wallbox LPWU/A/C. Installez La Partie 162mm Laté De Murage Verticale. Installez La Partie Intérieure Du Radiateur Au Moins A 100mm Au-dessus Du Plancher Fini.  
**MODEL: LPW2740T WATTS: 4000 VOLTS: 277**  
 CIRCLE MAXIMUM WATTS THIS HEATER IS WIRED FOR  
 277 VOLT: 4000-3000-2000-1000  
 MADE IN U.S.A.

It is *extremely important* to verify that the electrical power supply is the same voltage as the heater you are installing. 208 / 240 / 277 and 120 Volt heaters are not interchangeable! Powering a 208 / 240 / 277 Volt unit with 120 Volt supply wires will reduce the heater's output by approximately 75%. Powering a 120 Volt unit with 208 / 240 / 277 Volt supply wires will destroy the heater and voids all warranties.

### Selecting a location for your heater:

Do Not install less than 6 inches from vertical side walls or open edge of door. This heater must have an unrestricted airflow. Do Not select a location where it is likely to be blocked by furniture, curtains, etc. Be sure the location selected allows sufficient space for the heater as shown below in Table 1. Do Not locate this heater in an area where combustible vapors, gases, flammable liquids, or excessive lint, dust or moisture is present.

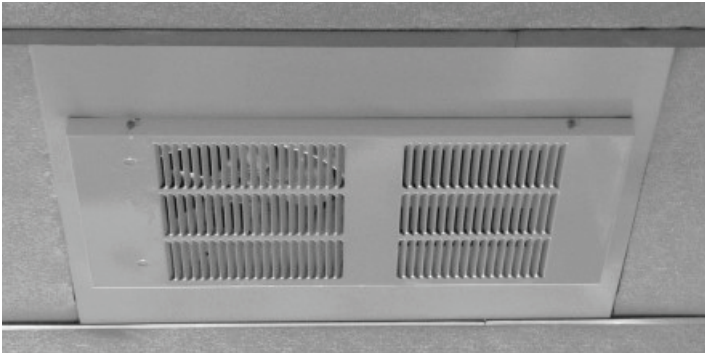

Table 1

Minimum Clearances for heater:			
Front	TOP	BOTTOM	SIDES
36 in	12 in	4 in	6 in
0.9 m	30.5 cm	10.2 cm	15.2 cm

Zero clearance to insulation.

## INSTALLATION INSTRUCTIONS

1. Remove heater contents from carton.
2. Remove grill by loosening the four mounting screws along the sides of the front panel.
3. Detach interior assembly from the ceiling case by removing the four screws along each side of the interior panel. Lift and tilt assembly away from the top of the ceiling case. Free the bottom edge from the metal lip inside the ceiling case. Place the interior assembly in a safe location until the ceiling case is mounted.
4. Mount heater enclosure can on ceiling joists a minimum of 6" from side wall, using the holes provided in the sides of the case. The face of the case should be flush with the finished ceiling surface. Installation of the interior and grill to the ceiling case will cover an approximate 1/2" periphery along outer area of the opening.
5. After ceiling case is secured, interior assembly leads may be attached to supply wires and interior secured to ceiling case.

**NOTE:** The heater's two steel elements allow for selection of various wattages. The heater is factory-wired at the maximum wattage.

To adjust the heater for lower wattages remove appropriate colored wire according to the wattage diagram provided on the back side of this sheet. Be sure to insulate and secure the unused lead.

6. Reinstall interior assembly on ceiling case using screws provided.
7. Mount grill to interior with screws provided.
8. Installation is now complete and the heater ready for use.
9. Use a single pole line voltage wall thermostat or field installed built in thermostat kit (purchased separately).

**FAN DELAY FEATURE:** The fan delay feature enables the fan to run after the thermostat turns off in order to remove residual heat from the elements. You may see the fan cycle on and off a few times until the elements have cooled. This is normal operation.

# 120/208/240/277 VOLT WIRING

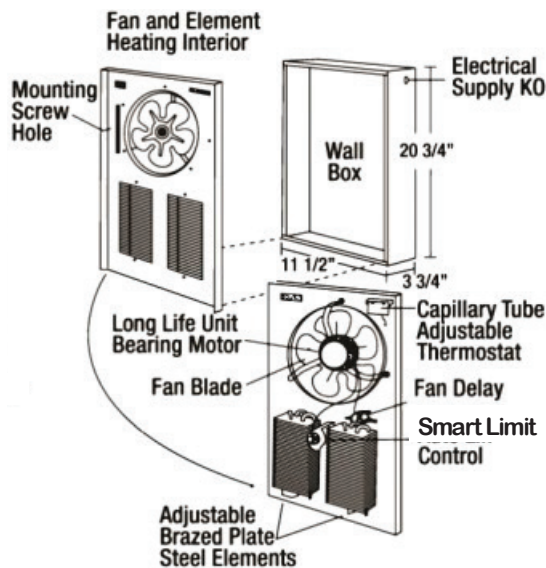
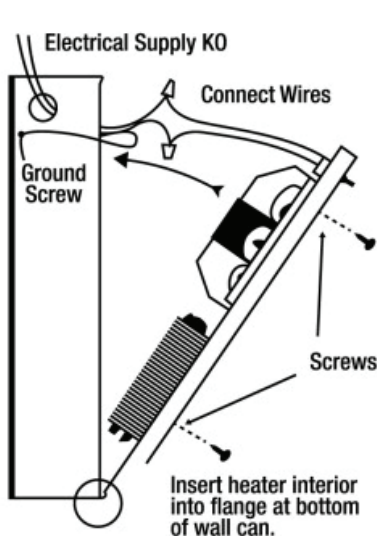

## Wiring Diagram

### INSTALLATION INSTRUCTIONS

This heater is shipped from the factory wired for maximum wattage. To reduce the wattage unplug (disconnect) an insulated push on terminal and wrap with electrical tape to prevent the possibility of electrical contact with other parts.

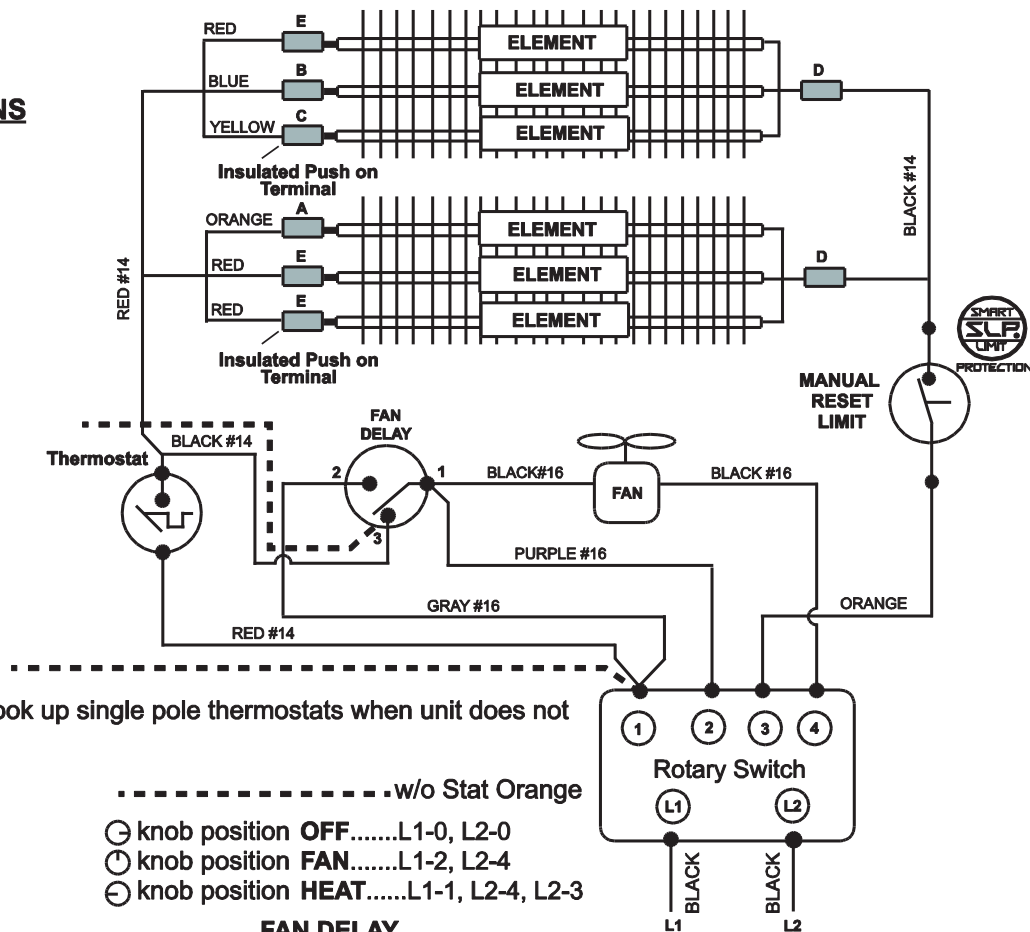

Note: Use orange lead wires to hook up single pole thermostats when unit does not have built in thermostat option.

- w/o Stat Orange
- ⊖ knob position OFF.....L1-0, L2-0
  - ⊙ knob position FAN.....L1-2, L2-4
  - ⊙ knob position HEAT.....L1-1, L2-4, L2-3
- FAN DELAY**  
1-3 N.C., 1-2 N.C. 1-2 Closes on Temp Rise

# FIELD WATTAGE SELECTION

## Field Wattage Selection

- A - ORANGE Disconnects 750 Watts
- B - BLUE Disconnects 500 Watts
- C - YELLOW Disconnects 250 Watts
- D - BLACK Do Not Disconnect (Common)
- E - RED Do Not Disconnect

**120V 2750W**

**Pic-A-Watt®**  
Metal Sheath Element

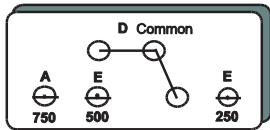
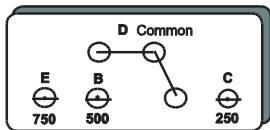

END VIEW OF ELEMENT  
SHOWING QUICK CONNECT TERMINALS

## Field Wattage Selection

- A - ORANGE Disconnects 1000 Watts
- D - BLACK Do Not Disconnect (Common)

**277V 4000W**

**Pic-A-Watt®**  
Metal Sheath Element

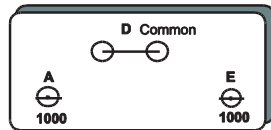
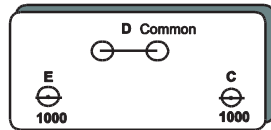

END VIEW OF ELEMENT  
SHOWING QUICK CONNECT TERMINALS

## Field Wattage Selection

- A - ORANGE Disconnects 1000 Watts
- B - BLUE Disconnects 750 Watts
- C - YELLOW Disconnects 500 Watts
- D - BLACK Do Not Disconnect (Common)
- E - RED Do Not Disconnect

**208V 4000W**

**Pic-A-Watt®**  
Metal Sheath Element

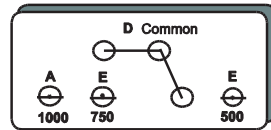
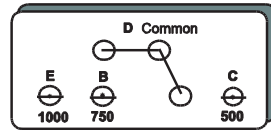

END VIEW OF ELEMENT  
SHOWING QUICK CONNECT TERMINALS

## Field Wattage Selection

- A - ORANGE Disconnects 1000 Watts
- B - BLUE Disconnects 750 Watts
- C - YELLOW Disconnects 500 Watts
- D - BLACK Do Not Disconnect (Common)
- E - RED Do Not Disconnect

**208/240V 4500W**

**Pic-A-Watt®**  
Metal Sheath Element

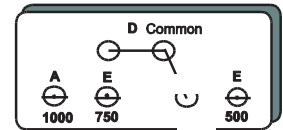
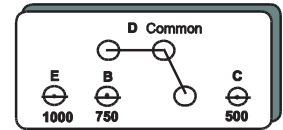

END VIEW OF ELEMENT  
SHOWING QUICK CONNECT TERMINALS

# OPERATING INSTRUCTIONS

## LPWC Heater



This heater is equipped with a thermal overload SMART LIMIT PROTECTION which disconnects elements (fan delay & fan only function still works) in the event normal operating temperatures are exceeded. If thermal overload trips due to abnormal operating temperatures, thermal overload remains open until manually reset by turning the heater Off for 15 minutes. Inspect for any objects on or adjacent to the heater that may cause high temperatures. After inspecting the heater, keep the power to the heater off for 15 minutes to reset the SLP thermal protector. If the SLP thermal protector shuts the heater off again, immediately turn the heater OFF at the circuit breaker and inspect the heater for possible fan motor failure or dirt and lint on the heating element. Repeat the starting procedure.

**DO NOT TAMPER WITH, BYPASS OR REMOVE THIS HIGH LIMIT DEVICE.**

### General information and guidelines:

This heater must be properly installed before it is used. DO NOT tamper with or change the operation of this heater. Service personnel refer to Maintenance & Warranty section for service of any type.

### Operation:

1. This heater must be properly installed in accordance with the National Electrical Codes (NEC) & local electrical codes before it is used.
2. After the electric heater has been completely installed, all thermostats should be turned to LOW or NO HEAT. Turn ON breakers, test fan. Only then turn to heat & turn up thermostat; wait 3 to 5 minutes. Check to see that the heater is operating correctly. If the heater is not operating, disconnect power by turning Off heater & breaker and check wiring connections.
3. Allow entire system to operate steadily for 1/2 hour. This should remove oily residue from manufacturing. (Some smoking may occur).
4. Select the setting for comfort on thermostat.
5. A safety limit control is provided to turn off the heater automatically if it is blocked or otherwise overheats due to an abnormal condition. DO NOT bypass or remove this safety device from the electrical circuit—see Warning Figure 2-2 on page 5. During normal use, this safety control should not operate. If you find that this control is operating, make sure the heater is not being blocked. If it continues to cycle the heater off, disconnect power to heater and have it checked and or repaired by a qualified electrician.

**Table 3**

<b>SYMPTOM</b>	<b>PROBLEM</b>	<b>SOLUTION</b>
Breaker Trips	<ol style="list-style-type: none"> <li>1. Short Circuit</li> <li>2. Overloaded Circuit</li> <li>3. Improper Voltage</li> </ol>	<ol style="list-style-type: none"> <li>1. Find source of short. Trace heater circuit and verify the heater is connected properly.</li> <li>2. Reduce wattage in circuit. Refer to Table 2 for maximum amperage.</li> <li>3. Verify the heater voltage matches the supply voltage.</li> </ol>
Heater not working	<ol style="list-style-type: none"> <li>1. No Power</li> <li>2. Loose Connections</li> <li>3. Defective Limit</li> </ol>	<ol style="list-style-type: none"> <li>1. Turn Breaker ON, turn thermostat ON, check that the breaker is position properly on panel bus-bar. A dedicated 2-Pole breaker must be connected to both bus-bars (A &amp; B phase) to produce 240V power.</li> <li>2. Remove &amp; retighten wire connections.</li> <li>3. Call factory.</li> </ol>
Heater Smokes	<ol style="list-style-type: none"> <li>1. Oil on element</li> <li>2. Needs Cleaning</li> </ol>	<ol style="list-style-type: none"> <li>1. It is normal for the element to burn off some light finishing oil used in the manufacturing process when first energized. Open windows and allow room to vent until it stops, usually within a few minutes.</li> <li>2. Remove any dust or dirt accumulations.</li> </ol>
Room Temperature does not match thermostat setting.	<ol style="list-style-type: none"> <li>1. Thermostat affected by another heat source.</li> <li>2. Improper calibration</li> </ol>	<ol style="list-style-type: none"> <li>1. Sunlight or other heat sources can affect the thermostat. Move the thermostat to another location (No Stat Unit Only) or remove the heat source.</li> <li>2. Adjust calibration screw. Call factory.</li> </ol>
Room Temperature swings from too hot to too cold.	<ol style="list-style-type: none"> <li>1. Defective or low quality thermostat (No Stat Unit Only)</li> </ol>	<ol style="list-style-type: none"> <li>1. Replace with a better quality thermostat. Anticipated thermostats are fairly accurate; and electronic thermostat are best.</li> <li>2. Must have 22 amp rated thermostat</li> </ol>

## MAINTENANCE AND WARRANTY

Maintenance & Cleaning: Basic maintenance is listed below and should be performed annually. When necessary, any required servicing should be performed by qualified service personnel. Your heater will give you years of service and comfort with only minimum care. To assure efficient operation follow the simple instructions below.

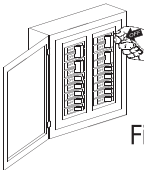

Figure 2

**WARNING:** Turn the electrical power OFF at the electrical panel board (circuit breaker or fuse box) and lock or tag this panel board door to prevent someone from turning on power while you are working on this heater. Failure to do so could result in serious electrical shock, burns, or possible death.

**Before cleaning this heater, the heating element of the heater must be cool.**

1. Before removing grill, turn the electrical power OFF. Circuit breakers are often not marked correctly and turning the wrong breaker off could mean electricity is flowing to the heater, even if the heater does not appear to be working. If you are uncomfortable working with electrical appliances, unable to follow these guidelines, or do not have the necessary equipment, consult a qualified electrician. Once you verify the power is off completely, proceed to the next step.
2. Remove screws and take off grill. Wash grill with hot soapy water and dry immediately
3. Using a hair dryer or vacuum on blow cycle, hold the fan in place to prevent it from turning and blow debris back through the element. Do not touch element. Vacuum lose debris without touching the elements.
4. Replace grill and secure with screws.
5. Turn power back ON at the electrical panel board.
6. Turn thermostat to desired setting.

## WARRANTY INFORMATION

King Electrical Manufacturing Company will repair or replace, without charge to the original owner, any LPW Series heater found to be defective or malfunctioning within 2 years of installation. This warranty requires the owner or his agent install the equipment in accordance with the National Electrical Code, any other applicable heating or electrical codes, and the manufacturer's installation instructions. It further requires that reasonable and necessary maintenance be performed on the unit. Failure to properly maintain the unit will result in the warranty being voided. The company is not liable for abuse or misuse of product as may be finally determined by the company. The customer shall be responsible for all costs incurred in the removal or reinstallation of products, including labor costs and shipping costs incurred to return products to King Manufacturing. King Manufacturing will repair or replace, at our option, at no charge to the customer with return freight paid by King. King Manufacturing shall not be liable for consequential damages arising with respect to the product, whether based upon negligence, tort, strict liability or contract. No other written or oral warranty applies, nor any warranties by representatives dealers, employees of King, or any other person. All returns require a King Return Goods Authorization (RGA); Unauthorized returns will be refused. Do not return malfunctioning/defective products to store.