

Architectural Convection Cabinet Heater KLI Series



Model Code:

KLI	20	15	-3	-690
A	B	C	D	E
A: Series				
B: Volts (12=120, 20=208, 24=240, 27=270)				
C: Watts (15=1500)				
D: Phase (1 or 3)				
E: Length in mm (-690=690mm)				

- 3 steel tubular heating elements with aluminum fins
- Front fresh air inlet; top warm air outlet
- Standard Watt density of 1000W/ft. (3280W/m)
- Low Watt density of 750W/ft. (2460W/m)
- Linear high-limit temperature control with automatic reset
- Standard color: bright white (optional almond color available)
- 20 Gauge Steel Cabinet
- Available in 120, 208, 240, 277 or 600 Volts, 1 Or 3 phase
- 1-year warranty against defects



The KLI Series Cabinet Heater

The KLI series units offer all of the advantages of the KLA convector heater with the added characteristic of a sloped top which prevents objects from being placed on them. These natural convection heaters are well suited for applications requiring a power rating of 6000W without fan noise. Several options are also available for wall-to-wall installation. Perfect for hospitals or daycares.

NOT APPROVED FOR RESIDENTIAL USE.

Ordering Information Standard models (1000W/ft)

WATTS	240V/208V	208V (1 ph)	UPC	208V (3 ph)	UPC	240V/208V	UPC	277V	UPC	LENGTH	WT. (lbs.)
2000	2000/1500W	KLI2020-1	31180	KLI2020-3	31190	KLI2420-1	31200	KLI2720-1	31210	27 3/16	37
3000	3000/2250W	KLI2030-1	31182	KLI2030-3	31192	KLI2430-1	31202	KLI2730-1	31212	37 3/16	47
4000	4000/3000W	KLI2040-1	31184	KLI2040-3	31194	KLI2440-1	31204	KLI2740-1	31214	47 3/16	57
5000	5000/3750W	KLI2050-1	31186	KLI2050-3	31196	KLI2450-1	31206	KLI2750-1	31216	57 3/16	67
6000	6000/4500W	KLI2060-1	31188	KLI2060-3	31198	KLI2460-1	31208	KLI2760-1	31218	65 3/16	79

Ordering Information Low density models (750W/ft)

WATTS	208V (1 ph)	UPC	208V (3 ph)	UPC	240V	UPC	277V	UPC	LENGTH	WT. (lbs.)
1500	KLI2015-1-690	31220	KLI2015-3-690	31228	KLI2415-1-690	31236	KLI2715-1-690	31244	27 3/16	37
2250	KLI2022-1-944	31222	KLI2022-3-944	31230	KLI2422-1-944	31238	KLI2722-1-944	31246	37 3/16	47
3000	KLI2030-1-1198	31224	KLI2030-3-1198	31232	KLI2430-1-1198	31240	KLI2730-1-1198	31248	47 3/16	57
4500	KLI2045-1-1655	31226	KLI2045-3-1655	31234	KLI2445-1-1655	31242	KLI2745-1-1655	31250	65 3/16	79

Engineering Specifications

Contractor shall supply and install KLI Series electric heaters of the wattage and voltage as indicated on the plans.

Color: Standard: white, almond. Optional: metallic silver, bronze, metallic charcoal, aluminum, semi-gloss black. Custom colors available upon request.

Finish: Standard: epoxy/polyester powder paint.

Voltage: 208V, 240/208V, 277V, 347V, 600V, 1 or 3-phase.

Construction: 20-gauge steel cabinet. 16-gauge steel front cover. Extruded aluminum bar grilles prevent insertion of foreign objects. Front fresh air inlet; top warm air outlet. Clean back available (-BD). Linear high-limit temperature control with automatic reset.

Heating element: Three stainless steel tubular heating elements with aluminum fins. Floating elements on high-temperature nylon bushings eliminating expansion noises.

Watt density: Standard watt density. Low watt density.

Control: Built-in tamperproof thermostat available. Mechanical, electronic or pneumatic relays available. Note: Single-pole thermostat is for 1-phase model only. King highly recommends to use an electronic wall thermostat for greater comfort.

Installation: Not for residential use in the United States. Wall or floor mounted installation. Mounting holes spaced on 2 in. (51 mm) intervals for ease of installation. Variety of accessories available for wall-to-wall installation. Pedestal kit or sub-base available.

Warranty: 1-year warranty against defects.

Application: Commercial building, hospital, daycare center.

Architectural Convection Cabinet Heater KLI Series

Options

ADD SUFFIX	DESCRIPTION
-BW	Bright White
-A	Almond Color
-AE	Metallic Silver
-BZ	Bronze
-CM	Metallic Charcoal
-AL	Aluminum
-NL	Semi-Gloss Black
-BD	Clean back

Dimensional Data

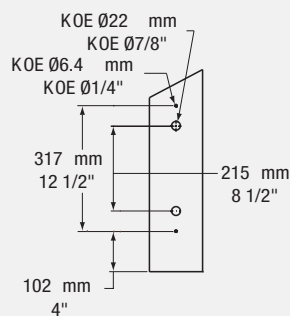

Right side view

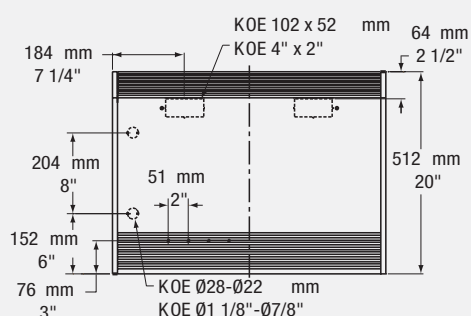

Front view

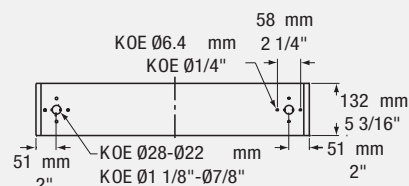

Bottom view

Control Options

MODEL	DESCRIPTION
KLI-T-AV	Single-pole tamperproof thermostat 30A, 250V max. - 15A, 600V max.
KLI-T2-AV	Double-pole tamperproof thermostat 30A, 250V max. - 15A, 600V max.
Product no-CTT	Single-pole relay, coil (240V), 25A, 240V - 12.5A, 600V (Factory Installed Only)
Product no-CTT2	Double-pole relay, coil (240V) 25A, 240V - 12.5A, 600V (Factory Installed Only)
KLI-R	Single-pole relay, coil (24V) 22A, 208V, 240V - 22A, 208V
KLI-R2	Double-pole relay, coil (24V) 25A, 240V - 12.5A, 600V
KLI-RT-208	Single-pole relay, coil (24V) Transformer (208V / 24V) - 4500W, 208V / 22A
KLI-RT-240	Single-pole relay, coil (24V) Transformer (240V / 24V) - 5200W, 240V / 22A
KLI-RT-277	Single-pole relay, coil (24V) Transformer (277V / 24A) - 5200W, 277V / 19A
Product no-TRF24	Transformer, 24V - 50VA
Product no-TRF240	Transformer, 240V - 50VA
Product no-PM	Factory installed pneumatic relay, 20A / 600V max.
KLI-CTR	Control box (width: 12")
Product no-DIS40	Factory installed disconnect switch 600V, three-pole, 40A

Accessories

MODEL	DESCRIPTION	DIMENSIONS (in)
KLI-CI	Corner (interior and exterior)	
KLI-PEC	Pedestal kit (2)	3 (height)
KLI-SO-27	Sub-base	27 3/16
KLI-SO-37	Sub-base	37 3/16
KLI-SO-47	Sub-base	47 3/16
KLI-SO-57	Sub-base	57 3/16
KLI-SO-65	Sub-base	65 3/16
KLI-SV-27	Empty cabinet	27 3/16
KLI-SV-37	Empty cabinet	37 3/16
KLI-SV-47	Empty cabinet	47 3/16
KLI-SV-57	Empty cabinet	57 3/16
KLI-SV-65	Empty cabinet	65 3/16
Product no-BD	Factory installed clean back	

*** Filler sections can be cut on workplace. Includes ends and wall supports.