

Model #	PRS-CH3(WH)-MB
SKU#	19671
Description	3 Light Chandelier
Finish	Matte Black
Glass	White
Replacement Glass	G-PRS-WH
Dimensions- HxW (Dimensions shown in inches)	20.25" x 18.5"
Lamp Info	3X60W (M)
Chain/Wire Length	3' Chain/10' Wire

Finish/Glass Shown: Matte Black/White

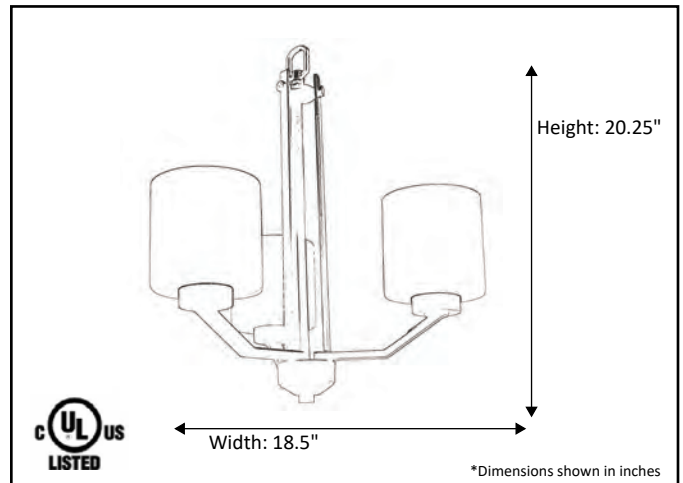

*Lamps not included



ELECTRICAL REQUIREMENTS: Fixture requires a grounded electrical supply line of 120 volts AC.

INSTALLATION REQUIREMENTS: Fixture attaches to electrical junction box securely anchored in wall or ceiling.
All mounting hardware included.

HOMEnhancements / 1505-A Kelly Blvd., Carrollton, TX. 75006

Product specifications subject to change without notice.

REFERENCE	QTY.	REMARKS	Project
			Location/Type
			Architect
			Engineer
			Contractor
			Submitted By: Date: