

Project Name:	Type:
Part Number:	Date:

# MULTIFIT FLAT ROUND

## SPECIFICATION FEATURES

- Mechanical** - Compact fixture body made from die cast aluminum for maximizing passive cooling ensuring long life lasting LED, non yellowing frosted polycarbonate lens for optimal light diffusion. Proprietary IC-rated potted driver for optimal heat protection, with hot-dip galvanized steel box and easy tool-less opening attached clipping lid. Rugged spring clips allow for both easy direct installation from 3/8" to 1" ceiling thickness and field accessibility below the ceiling for service or replacement. Additional mounting plates also available if required. Plenum rated cable and connector to connect from downlight to remote driver box.
- Electrical** -The driver features DualDim technology, for maximum adaptability in any spaces whether it's commercial, residential or mixed. Rated for 120V to 277V, 50/60 Hz the driver is both 0-10V dimmable to 5% with low-end cut off and Forward and Reverse phase dimmable at 120V down to 10%. Please consult dimmer compatibility for additional information. Drivers also feature easy accessible outside switch for selecting the right color temperature. Coming with four 7/8" knockout, and suitable for pulling wires to accommodate up to (6) 12 gauge 90°C insulated conductors, making the MULTIFIT downlights fast and easy to wire in daisy-chain applications and contractor friendly. Sound rating <22db.
- Optical** - Featuring SelectKelvin technology with field selectable CCTs 2700/3000/3500/4000/5000K. LED binning within 4 SDCM maximum. Offered in minimum 90 CRI. 110° optical beam angle. Edge-lite technology for minimizing glare.
- Thermal** - Die cast heat sink maximizes passive thermal management and achieves a L70 rated lifetime of 50,000+ hours. Ambient temperature rated from -5°F to 113°F (-15°C to 45°C).
- Compliance and Warranty** – ETL Listed for wet location. Certified air-tight per ASTM 283-04. Complies with FCC 47CFR Part 15B consumer limits for EMI/RFI emissions. Suitable for use in clothes closets when installed in accordance with the NEC 410.16 spacing requirements. Certified IC for direct contact with insulation. 5 Year Warranty for complete fixture. Optional 10 Year Extended Warranty available, subject to same terms, conditions and installation requirements as standard 5 Year Warranty



020623



## BENEFITS

- MULTIFIT provides the easiest retrofitting or new installation dimming compatibility with DualDim technology
- SelectKelvin technology to choose from five color temperatures ranging from 2700K to 5000K
- Install virtually anywhere with Wet Location, IC and Air-tight ratings
- Quick and easy installation with spring action clip even in the shallower plenums
- External driver with quick connector for easy wiring and daisy chain application

## APPLICATIONS

- Retail
- Hospitality
- Residential
- Education
- Healthcare

# MULTIFIT FLAT ROUND

## ORDERING INFORMATION

### ORDERING EXAMPLE:

MFR6/9CCT5S/DUALDIM/EXT

**MFR(size)** / **(CRI+CCT)** / **(Driver)** / **(Driver Style)**

### MULTIFIT FLAT

Model Series	Size	CRI	CCT	Driver	Driver Style
<b>MFR</b> MULTIFIT Round Flat	<b>4</b> 4" 600lm	<b>9</b> CRI 90+	<b>CCT5S</b> Selectable CCT 2700 / 3000 / 3500 / 4000 / 5000K	<b>DUALDIM</b> 120V-277V, 50/60Hz. 0-10V or Forward/Reverse phase dimming at 120V only.	<b>EXT</b> External Driver box with quick connector
	<b>6</b> 6" 800lm				
	<b>6HO</b> 6" 1000lm				
	<b>8</b> 8" 1500lm				
	<b>8HO</b> 8" 2000lm				

## LINE DRAWINGS

### MFR

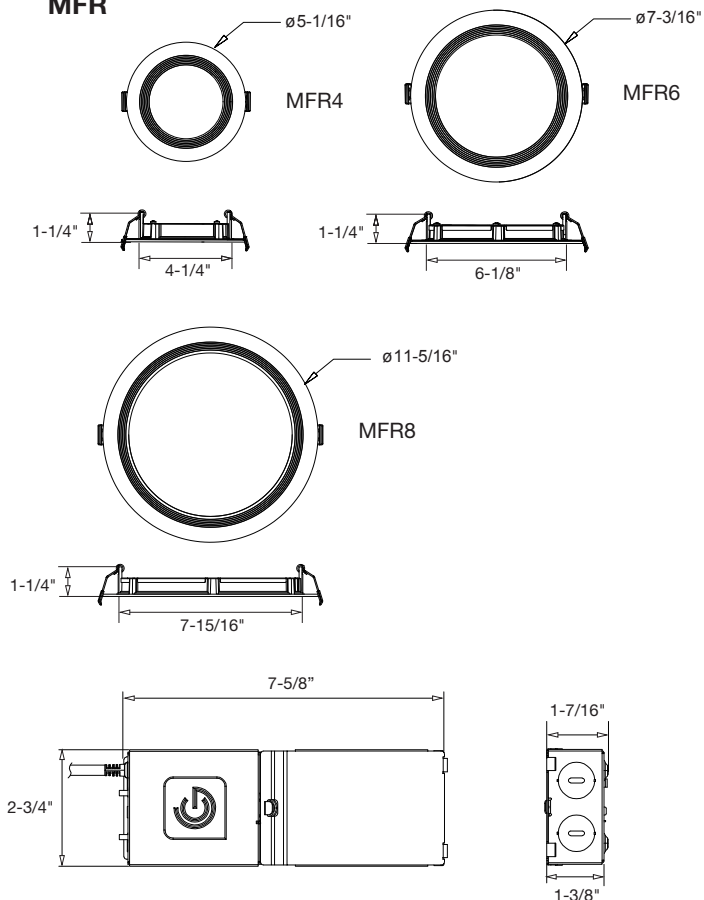

### MFR4

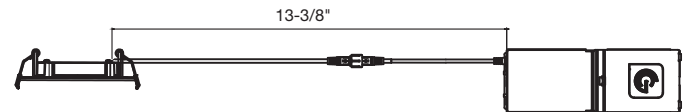

### MFR6

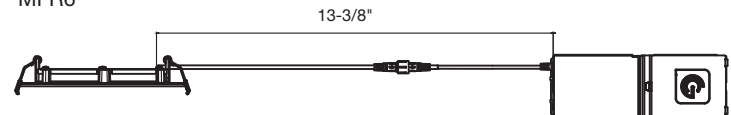

### MFR8

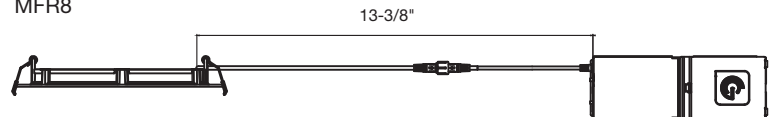

### Ceiling Cutout

Type	Minimum	Maximum
MFR4	4-1/4"	4-5/8"
MFR6/6HO	6-1/8"	6-7/8"
MFR8/8HO	7-15/16"	8-9/16"



# MULTIFIT FLAT ROUND

## TECHNICAL INFORMATION

Type	Dimming	Input Voltage	Input Frequency	Input Current	Max. Input Power	THD Power	Power Factor	Flicker Index	Sound Rating
MFR4	0-10V and ELV/TRIAC	120-277V	50-60Hz	0.06 / 0.04A	8W	<20%	>0.9	<30%	<22db
MFR6				0.08 / 0.04A	10W				
MFR6HO				0.11 / 0.06A	14W				
MFR8				0.14 / 0.07A	18W				
MFR8HO				0.20 / 0.09A	25W				

## NOMINAL PERFORMANCE



CCT	2700K			3000K			3500K			4000K			5000K		
Power/lumen/Efficacy	Power	Lumens	Efficacy	Power	Lumens	Efficacy	Power	Lumens	Efficacy	Power	Lumens	Efficacy	Power	Lumens	Efficacy
MFR4	8.4W	620lm	74LPW	8.5W	643lm	76LPW	8.4W	663lm	79LPW	8.4W	667lm	80LPW	8.3W	656lm	79LPW
MFR6	9.3W	733lm	79LPW	8.5W	746lm	79LPW	9.4W	766lm	82LPW	9.4W	773lm	83LPW	9.25W	771lm	83LPW
MFR6HO	14.5W	1017lm	70LPW	14.7W	1050lm	71LPW	14.5W	1092lm	75LPW	14.5W	1107lm	76LPW	14.3W	1092lm	76LPW
MFR8	17.2W	1394lm	81LPW	17.4W	1441lm	83LPW	17.1W	1487lm	87LPW	17.1W	1506lm	88LPW	17.0W	1492lm	88LPW
MFR8HO	23.8W	1815lm	76LPW	24.1W	1884lm	78LPW	23.8W	1971lm	83LPW	23.7W	1998lm	84LPW	23.7W	1942lm	82LPW

## ACCESSORY ORDERING INFORMATION

Product	Model	Description	Pictures	Dimensions
35121	NCFJB4	Round New Construction Frame w/ Jbox 4"		
35122	NCFJB6	Round New Construction Frame w/ Jbox 6"		
35123	NCFJB8	Round New Construction Frame w/ Jbox 8"		
98502	NCPLATE468	4" & 6" MULTIFIT EXT Series New Construction Plate for Stud/Joist Mounting		 A: Ø4-5/16" B: Ø8-1/16" C: Ø6-5/16"
98501	NCPLATE/T4689	New Construction or Remodel Plate for T-Grid Ceilings		 A: Ø4-5/16" B: Ø6-5/16" C: Ø8-1/16" D: Ø9"
98569	GOOFRING4	4" Goof Ring - Outer Diameter 8-1/8"		 Ø4-1/8"
98568	GOOFRING6	6" Goof Ring - Outer Diameter 10-1/2"		 Ø6-5/16"

# MULTIFIT FLAT ROUND

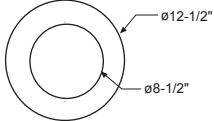
## ACCESSORY ORDERING INFORMATION

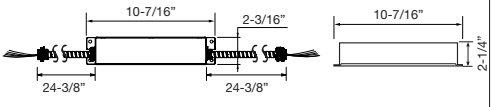
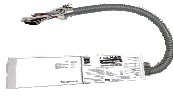
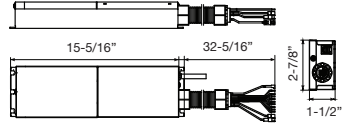
Product	Model	Description	Pictures	Dimensions
98567	GOOFRING8	8" Goof Ring - Outer Diameter 12-1/2"		
98003	23EMDRIVER	California Title 20 Compliant 23W Emergency LED Driver (Field Installation)		
FHUPS1-UNV-25L-SD	FHUPS1-UNV-25L-SD	25W Emergency Micro Inverter for field installation to use with 0-10V Driver options. 100-277VAC (up to 150W with use of 0-10V dimming). CEC Compliant		

## ORDERING GUIDE

Product	Model	Case Quantity
36998	MFR4/9CCT5S/DUALDIM/EXT	12pcs
36999	MFR6/9CCT5S/DUALDIM/EXT	12pcs
37000	MFR6HO/9CCT5S/DUALDIM/EXT	12pcs
37001	MFR8/9CCT5S/DUALDIM/EXT	12pcs
37002	MFR8HO/9CCT5S/DUALDIM/EXT	12pcs

## CERTIFICATION INFORMATION

Product	Model	ES ID#
36998	MFR4/9CCT5S/DUALDIM/EXT	2403392
36999	MFR6/9CCT5S/DUALDIM/EXT	2403393
37000	MFR6HO/9CCT5S/DUALDIM/EXT	2403387
37001	MFR8/9CCT5S/DUALDIM/EXT	2403579
37002	MFR8HO/9CCT5S/DUALDIM/EXT	2403390

## PHOTOMETRY

MFR4/9CCT5S/DUALDIM/EXT (at 3500K)

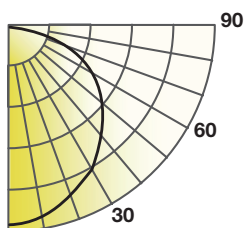

Lumens: 691 lm  
 CBCP: 247 cd  
 Power: 8.0 W  
 Efficacy: 86 lm/W  
 CRI: 92  
 Spacing Criteria: 1.2  
 Beam Angle: 113°

Candlepower Distribution	
Angle (°)	Average (cd)
10	243
20	230
30	209
40	182
50	149
60	109
70	63
80	18
90	0

Initial Footcandles		
Height (ft)	Fc	Diameter (ft)
10	4	30
20	1	61
30	0	91
40	0	121
50	0	151
60	0	182
70	0	212
80	0	242
90	0	272

Zonal Lumen Summary		
Zone	Lumens	%Fixt
0-30	192	28
0-40	314	46
0-60	558	81
0-90	691	100



# MULTIFIT FLAT ROUND

## PHOTOMETRY

MFR6/9CCT5S/DUALDIM/EXT (at 3500K)

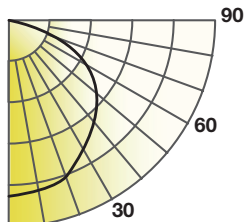

Lumens: 860 lm  
CBCP: 301 cd  
Power: 10.0 W  
Efficacy: 89 lm/W  
CRI: 92  
Spacing Criteria: 1.3  
Beam Angle: 114°

Candlepower Distribution	
Angle (°)	Average (cd)
10	295
20	279
30	254
40	220
50	180
60	135
70	83
80	30
90	0

Initial Footcandles		
Height (ft)	Fc	Diameter (ft)
8	7	24
10	4	31
12	3	37
15	2	46
20	1	61

Zonal Lumen Summary		
Zone	Lumens	%Fixt
0-30	233	27
0-40	382	44
0-60	679	79
0-90	860	100

MFR6HO/9CCT5S/DUALDIM/EXT (at 3500K)

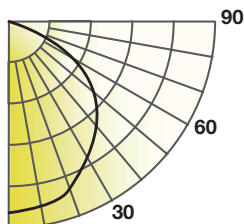

Lumens: 1,219 lm  
CBCP: 446 cd  
Power: 15.0 W  
Efficacy: 85 lm/W  
CRI: 92  
Spacing Criteria: 1.2  
Beam Angle: 111°

Candlepower Distribution	
Angle (°)	Average (cd)
10	438
20	412
30	373
40	321
50	261
60	188
70	110
80	31
90	0

Initial Footcandles		
Height (ft)	Fc	Diameter (ft)
8	10	23
10	7	29
12	5	35
15	3	43
20	2	58

Zonal Lumen Summary		
Zone	Lumens	%Fixt
0-30	345	28
0-40	563	46
0-60	990	81
0-90	1,218	100

MFR8/9CCT5S/DUALDIM/EXT (at 3500K)

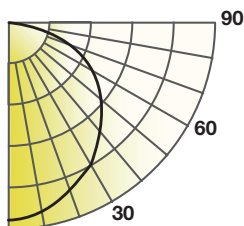

Lumens: 1,800 lm  
CBCP: 621 cd  
Power: 18.0 W  
Efficacy: 103 lm/W  
CRI: 92  
Spacing Criteria: 1.3  
Beam Angle: 115°

Candlepower Distribution	
Angle (°)	Average (cd)
10	608
20	577
30	526
40	458
50	376
60	284
70	176
80	72
90	2

Initial Footcandles		
Height (ft)	Fc	Diameter (ft)
8	14	25
10	11	28
12	9	31
15	6	37
20	4	47

Zonal Lumen Summary		
Zone	Lumens	%Fixt
0-30	482	27
0-40	791	44
0-60	1,410	78
0-90	1,800	100



# MULTIFIT FLAT ROUND

## PHOTOMETRY

MFR8HO/9CCT5S/DUALDIM/EXT (at 3500K)

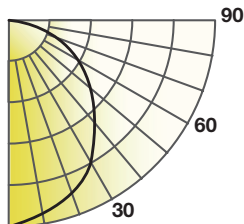

Lumens: 1,982 lm  
 CBCP: 729 cd  
 Power: 25 W  
 Efficacy: 82 lm/W  
 CRI: 92  
 Spacing Criteria: 1.2  
 Beam Angle: 109°

Candlepower Distribution	
Angle (°)	Average (cd)
10	714
20	672
30	605
40	520
50	419
60	302
70	176
80	57
90	0

Initial Footcandles		
Height (ft)	Fc	Diameter (ft)
8	17	23
10	11	28
12	7	34
15	5	42
20	3	56

Zonal Lumen Summary		
Zone	Lumens	%Fixt
0-30	561	28
0-40	915	46
0-60	1,600	81
0-90	1,980	100

Note: All rights reserved. All sizes and specifications are subject to change at any time without notice.