

Project Name:	Type:
Part Number:	Date:

ORBIT TRACK HEAD L

SPECIFICATION FEATURES

- **Mechanical** - Compact fixture body made from die cast aluminum and polycarbonate lens design provide high quality light to compliment any space. Polycarbonate fixture lens holder design allows accessories to easily hold or snap in place. Fixture bodies and matching accessories are available in matte black, matte white and silver.
- **Electrical** - Field selectable from 2 lumen outputs using SelectDrive technology. Universal 120V only, 50/60 Hz drivers available. 120V drivers are dimmable to 5% using TRIAC or ELV dimmers.
- **Optical** - Fixture rotates 350° and tilts up to 120°. 15° Spot, 25° Narrow and 35° Flood beam angles available. Minimum 90 CRI with 2-step SDCM COB binning. Available in 2700K, 3000K, 3500K or 4000K CCT
- **Thermal** - Die cast heat sink maximizes passive thermal management and achieves a L70 rated lifetime of 50,000 hours. Ambient temperature rated from -22°F to 95°F (-30°C to 35°C).
- **Compliance and Warranty** - ETL Listed for dry locations. Complies with FCC 47CFR Part 15B consumer limits for EMI/RFI emissions. 5 year parts warranty for complete fixture. ENERGY STAR® listed. JA8 Certified to meet CA Title 24 requirements.



080822



ASSOCIATED PRODUCTS
[TRACK SYSTEM](#)

BENEFITS

- Field selectable lumen output with SelectDrive technology.
- Compact cylindrical form factor compliments existing architecture.
- Matte black, white and silver finishes match existing track systems.
- H, J, and L track adapters with matching canopy mount available.
- Field interchangeable optics and accessories.

APPLICATIONS

- Retail
- Residential
- Hospitality
- Commercial
- Libraries and museums

LINE DRAWINGS

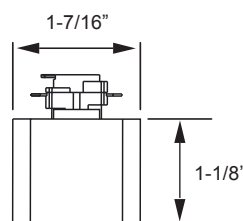
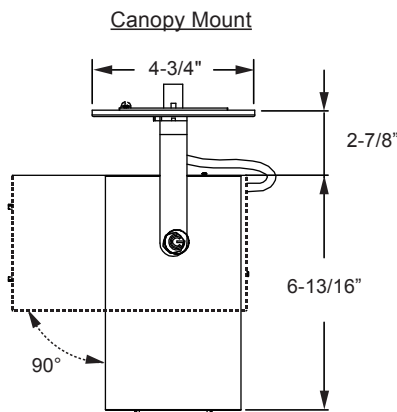

H-Halo Track
For use with single circuit track applications

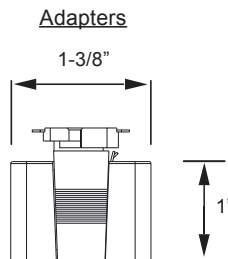

J-Juno Track
For use with single and two-circuit track applications

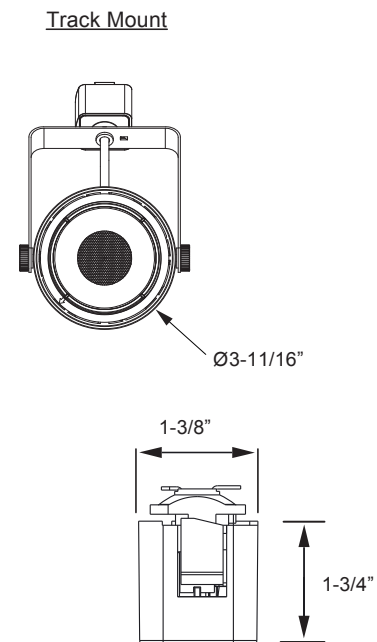

L-Lightlier Track
For use with single and two-circuit track applications



ORBIT TRACK HEAD L

ORDERING EXAMPLE













A complete fixture consists of Output, Adapter, CCT, Beam and Finish Selected

ORB/L/930/NR/DIM120V/H/BL

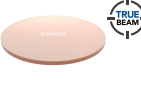
ORDERING INFORMATION

Series	Lumen	CRI	CCT	Beam Angle	DRIVER	Adapter	Finish
<input checked="" type="checkbox"/> ORB ORBIT	<input checked="" type="checkbox"/> L Large 3,000 / 4,000 lumens	<input checked="" type="checkbox"/> 9 CRI 90+	<input type="checkbox"/> 27 2700K	<input type="checkbox"/> FL Flood 35°	<input checked="" type="checkbox"/> DIM120V 120V, 50/60 Hz, Forward and Reverse Phase Line Voltage Dimming to 5%	<input type="checkbox"/> H Halo	<input type="checkbox"/> WH White
			<input type="checkbox"/> 30 3000K	<input type="checkbox"/> NR Narrow 25°		<input type="checkbox"/> J Juno	<input type="checkbox"/> BL Black
			<input type="checkbox"/> 35 3500K	<input type="checkbox"/> SP Spot 15°		<input type="checkbox"/> L Lightolier	<input type="checkbox"/> SV Silver
			<input type="checkbox"/> 40 4000K			<input type="checkbox"/> CM Canopy Mount	

ACCESSORIES ORDERING INFORMATION

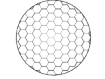
Product	Model	Description	Pictures	Product	Model	Description	Pictures
35379	ORB/ACC/L/SN/WH	Large Snoot White		35399	ORB/LENS/L/LS	Large Lens Linear Spread	
35380	ORB/ACC/L/SN/BL	Large Snoot Black		35400	ORB/LENS/L/SOL	Large Lens Solite	
35381	ORB/ACC/L/SN/SV	Large Snoot Silver		36917	ORB/LENS/L/CCT22	Large - CCT Shift Lens 2700K to 2200K	
35382	ORB/ACC/L/WW/WH	Large Wall Wash White		36918	ORB/LENS/L/CCT24	Large - CCT Shift Lens 2700K to 2400K	
35383	ORB/ACC/L/WW/BL	Large Wall Wash Black		35359	ORB/OPTIC/L/FL	Large Replacement Optic Flood 35°	
35384	ORB/ACC/L/WW/SV	Large Wall Wash Silver		35360	ORB/OPTIC/L/NR	Large Replacement Optic Narrow 25°	
35385	ORB/ACC/L/BD/BL	Large Barn Doors Black		35361	ORB/OPTIC/L/SP	Large Replacement Optic Spot 15°	
35364	ORB/ACC/L/HC ¹	Large Honeycomb Louver					

¹ HC only comes in black finish.

TECHNICAL INFORMATION

Dimming	Input Voltage	Input Frequency	Input Current	Input Power	THD Power	Power Factor
120V, Forward and reverse phase dimming to 5%	120V	50 / 60Hz	150 / 200mA	30 / 40W	<20%	>0.9



ORBIT TRACK HEAD L

PHOTOMETRY

Notes and Definitions:

- D=Distance to floor or wall
- FC=Footcandles on floor or wall at center beam location
- L=Effective Visual Beam length in feet
- W=Effective Visual Beam width in feet
- X=In vertical aiming applications, (X) is the distance down to the center beam location

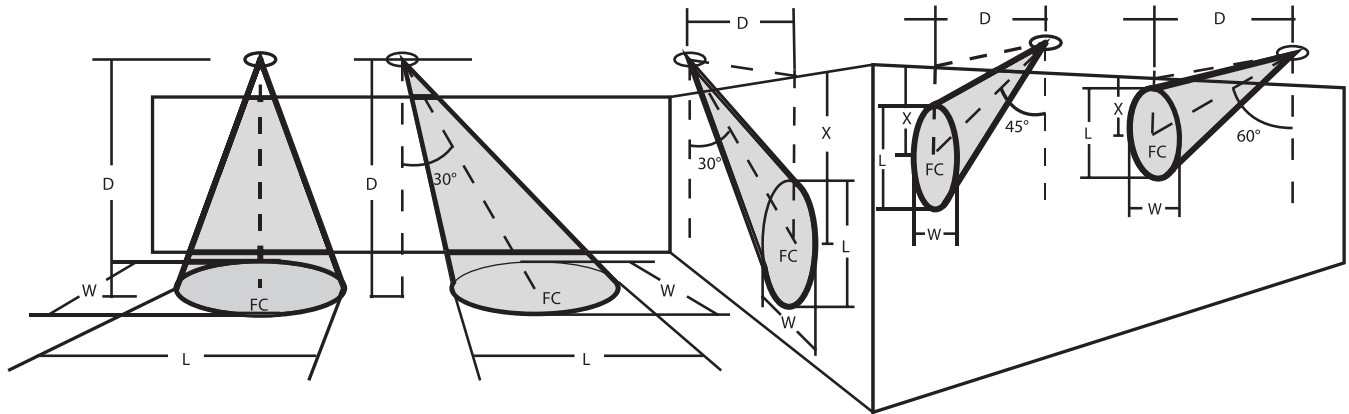

0° Horizontal Aiming Angle				30° Horizontal Aiming Angle				30° Vertical Aiming Angle				45° Vertical Aiming Angle				60° Vertical Aiming Angle			
ORB/L/930/SP/DIM120V/xx/yy Low Output (30W) Lumens: 2,847 Beam Angle: SPOT 17.2° CCT: 3000K CBCP: 2,2967				ORB/L/930/NR/DIM120V/xx/yy Low Output (30W) Lumens: 2,893 Beam Angle: NARROW 21.5° CCT: 3000K CBCP: 15,606				ORB/L/930/FL/DIM120V/xx/yy Low Output (31W) Lumens: 2,853 Beam Angle: FLOOD 36° CCT: 3000K CBCP: 7,333				ORB/L/930/SP/DIM120V/xx/yy High Output (40W) Lumens: 3638 Beam Angle: SPOT 16.8° CCT: 3000K CBCP: 30,834							
D	FC	L	W	D	FC	L	W	D	FC	L	W	D	FC	L	W	D	FC	L	W
6	638.0	1.8	1.8	6	478.5	2.4	2.1	3	637.9	3.9	1.8	3	1275.9	1.9	1.0	3	478.5	2.4	2.1
8	358.9	2.4	2.4	8	269.1	3.3	2.8	4	358.8	5.2	2.4	4	717.7	2.5	1.4	4	269.1	3.3	2.8
10	229.7	3.0	3.0	10	172.3	4.1	3.5	5	229.7	6.5	3.0	5	459.3	3.1	1.7	5	172.2	4.1	3.5
12	159.5	3.6	3.6	12	119.6	4.9	4.2	6	159.5	7.8	3.6	6	319.0	3.7	2.1	6	119.6	4.9	4.2
14	117.2	4.2	4.2	14	87.9	5.7	4.9	7	117.2	9.1	4.2	7	234.3	4.3	2.4	7	87.9	5.7	4.9
6	433.5	2.28	2.28	6	325.1	3.1	2.6	3	433.5	5.1	2.3	3	867.0	2.4	1.3	3	325.1	3.1	2.6
8	243.8	3.04	3.04	8	182.9	4.1	3.5	4	243.8	6.8	3.0	4	487.7	3.2	1.8	4	182.9	4.1	3.5
10	156.1	3.80	3.80	10	117.0	5.1	4.4	5	156.1	8.5	3.8	5	312.1	3.9	2.2	5	117.0	5.1	4.4
12	108.4	4.56	4.56	12	81.3	6.1	5.3	6	108.4	10.2	4.6	6	216.7	4.7	2.6	6	81.3	6.1	5.3
14	79.6	5.32	5.32	14	59.7	7.2	6.1	7	79.6	11.9	5.3	7	159.2	5.5	3.1	7	59.7	7.2	6.1
6	203.7	3.9	3.9	6	152.8	5.4	4.5	3	203.7	11.4	3.9	3	407.4	4.4	2.3	3	152.8	5.4	4.5
8	114.6	5.2	5.2	8	85.9	7.2	6.0	4	114.6	15.2	5.2	4	229.1	5.8	3.0	4	85.9	7.2	6.0
10	73.3	6.5	6.5	10	55.0	9.0	7.5	5	73.3	19.0	6.5	5	146.7	7.3	3.8	5	55.0	9.0	7.5
12	50.9	7.8	7.8	12	38.2	10.8	9.0	6	50.9	22.8	7.8	6	101.8	8.7	4.5	6	38.2	10.8	9.0
14	37.4	9.1	9.1	14	28.1	12.6	10.5	7	37.4	26.6	9.1	7	74.8	10.2	5.3	7	28.1	12.6	10.5
6	856.5	1.8	1.8	6	642.4	2.4	2.0	3	856.5	3.8	1.8	3	1712.9	1.8	1.0	3	642.4	2.4	2.0
8	481.8	2.4	2.4	8	361.3	3.2	2.7	4	481.8	5.1	2.4	4	963.5	2.4	1.4	4	361.3	3.2	2.7
10	308.3	3.0	3.0	10	231.3	4.0	3.4	5	308.3	6.3	3.0	5	616.7	3.0	1.7	5	231.2	4.0	3.4
12	214.1	3.5	3.5	12	160.6	4.8	4.1	6	214.1	7.6	3.5	6	428.2	3.6	2.0	6	160.6	4.8	4.1
14	157.3	4.1	4.1	14	118.0	5.6	4.8	7	157.3	8.8	4.1	7	314.6	4.2	2.4	7	118.0	5.6	4.8



ORBIT TRACK HEAD L

PHOTOMETRY

ORB/L/930/NR/DIM120V/xx/yy				High Output (40W)				Lumens: 3832				Beam Angle: NARROW 21.4°				CCT: 3000K				CBCP: 21,071			
D	FC	L	W	D	FC	L	W	D	FC	L	W	D	FC	L	W	D	FC	L	W	D	FC	L	W
6	585.3	2.3	2.3	6	439.0	3.1	2.6	3	585.3	5.1	2.3	3	1170.6	2.4	1.3	3	439.0	3.1	2.6	3	439.0	3.1	2.6
8	329.2	3.0	3.0	8	246.9	4.1	3.5	4	329.2	6.8	3.0	4	658.4	3.1	1.7	4	246.9	4.1	3.5	4	246.9	4.1	3.5
10	210.7	3.8	3.8	10	158.0	5.1	4.4	5	210.7	8.5	3.8	5	421.4	3.9	2.2	5	158.0	5.1	4.4	5	158.0	5.1	4.4
12	146.3	4.5	4.5	12	109.7	6.1	5.2	6	146.3	10.2	4.5	6	292.6	4.7	2.6	6	109.7	6.1	5.2	6	109.7	6.1	5.2
14	107.5	5.3	5.3	14	80.6	7.1	6.1	7	107.5	11.9	5.3	7	215.0	5.5	3.1	7	80.6	7.1	6.1	7	80.6	7.1	6.1

ORB/L/930/FL/DIM120V/xx/yy				High Output (40W)				Lumens: 3,758				Beam Angle: FLOOD 35.6°				CCT: 3000K				CBCP: 9,708			
D	FC	L	W	D	FC	L	W	D	FC	L	W	D	FC	L	W	D	FC	L	W	D	FC	L	W
6	269.7	3.9	3.9	6	202.3	5.3	4.4	3	269.7	11.2	3.9	3	539.3	4.3	2.2	3	202.2	5.3	4.4	3	202.2	5.3	4.4
8	151.7	5.1	5.1	8	113.8	7.1	5.9	4	151.7	14.9	5.1	4	303.4	5.7	3.0	4	113.8	7.1	5.9	4	113.8	7.1	5.9
10	97.1	6.4	6.4	10	72.8	8.9	7.4	5	97.1	18.6	6.4	5	194.2	7.2	3.7	5	72.8	8.9	7.4	5	72.8	8.9	7.4
12	67.4	7.7	7.7	12	50.6	10.6	8.9	6	67.4	22.3	7.7	6	134.8	8.6	4.4	6	50.6	10.6	8.9	6	50.6	10.6	8.9
14	49.5	9.0	9.0	14	37.1	12.4	10.4	7	49.5	26.0	9.0	7	99.1	10.0	5.2	7	37.1	12.4	10.4	7	37.1	12.4	10.4

ORB/L/930/SP/DIM120V/xx/yy Low Output (30W)

Lumens: 2,847lm
CBCP: 22,967cd
Power: 30W
Efficacy: 94lm/W
CRI: 90
Spacing Criteria: 0.34
Beam Angle: 17.2°

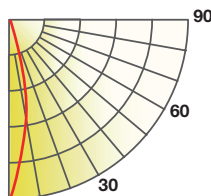

SPOT

Degree	Candela
0	22,967
15	3,153
25	473
35	96
45	49

ORB/L/930/SP/DIM120V/xx/yy High Output (40W)

Lumens: 3,638lm
CBCP: 30,834cd
Power: 40W
Efficacy: 92lm/W
CRI: 90
Spacing Criteria: 0.3
Beam Angle: 16.8°

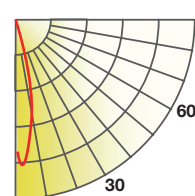

SPOT

Degree	Candela
0	30,834
15	3,769
25	553
35	116
45	58

ORB/L/930/NR/DIM120V/xx/yy Low Output (30W)

Lumens: 2,893lm
CBCP: 15,606cd
Power: 30W
Efficacy: 96.4lm/W
CRI: 90
Spacing Criteria: 0.4
Beam Angle: 21.5°

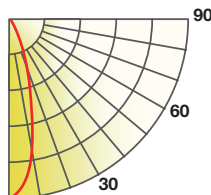

NARROW

Degree	Candela
0	15,606
15	4,095
25	750
35	119
45	66

ORB/L/930/NR/DIM120V/xx/yy High Output (40W)

Lumens: 3,832lm
CBCP: 21,071cd
Power: 40W
Efficacy: 98lm/W
CRI: 90
Spacing Criteria: 0.43
Beam Angle: 21.4°

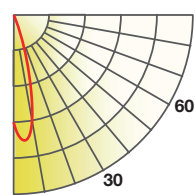

NARROW

Degree	Candela
0	21,071
15	4,986
25	957
35	146
45	82

ORB/L/930/FL/DIM120V/xx/yy Low Output (30W)

Lumens: 2,853lm
CBCP: 7,333cd
Power: 31W
Efficacy: 91.4lm/W
CRI: 90
Spacing Criteria: 0.64
Beam Angle: 36°

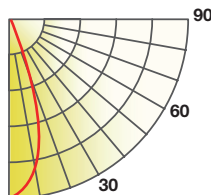

FLOOD

Degree	Candela
0	7,333
15	4,819
25	1329
35	164
45	66

ORB/L/930/FL/DIM120V/xx/yy High Output (40W)

Lumens: 3,758lm
CBCP: 9,708cd
Power: 40W
Efficacy: 92.69lm/W
CRI: 90
Spacing Criteria: 0.57
Beam Angle: 35.6°

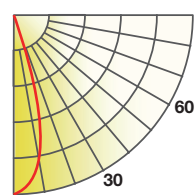

FLOOD

Degree	Candela
0	9,708
15	6,662
25	2,018
35	227
45	110

PERFORMANCE

CCT		2700K			3000K			3500K			4000K		
Series	Beam Angle	Output (lm)	Efficacy (lm/W)	CBCP (cd)	Output (lm)	Efficacy (lm/W)	CBCP (cd)	Output (lm)	Efficacy (lm/W)	CBCP (cd)	Output (lm)	Efficacy (lm/W)	CBCP (cd)
ORB L Low Output	Spot 15°	2,610	87	22,185	2,760	100	23,460	2,760	92	23,460	2,760	92	23,460
	Narrow 25°	2,700	90	14,850	2,850	100	15,675	2,850	95	15,675	2,850	95	15,675
	Flood 35°	2,610	87	6,525	2,760	100	6,900	2,760	92	6,900	2,760	92	6,900
ORB L High Output	Spot 15°	3,480	87	29,580	3,680	100	31,280	3,680	92	31,280	3,680	92	31,280
	Narrow 25°	3,600	90	19,800	3,800	100	20,900	3,800	95	20,900	3,800	95	20,900
	Flood 35°	3,480	87	8,700	3,680	100	9,200	3,680	92	9,200	3,680	92	9,200

Note: All rights reserved. All sizes and specifications are subject to change at any time without notice.