

Project Name:	Type:
Part Number:	Date:

ATOM TRACK HEAD

SPECIFICATION FEATURES

- **Mechanical** - Compact fixture body and field interchangeable LED module made from die cast aluminum. Proprietary driver and polycarbonate lens design provide high quality light to compliment any space. Fixture trim ring design allows accessories to easily snap in place. Fixture bodies and matching accessories are available in matte black and matte white.
- **Electrical** - Modular light engine with integrated driver. 120V, 50/60 Hz driver dims to 10% using most forward-phase or reverse-phase dimmers. Visit www.greencreative.com for a complete dimmer compatibility list.
- **Optical** - Fixture rotates 350° and tilts up to 90°. 25° Narrow and 35° Flood beam angles available. Minimum 90 CRI with 3-step SDCM LED binning. Available in 2700K, 3000K, 3500K or 4000K CCT.
- **Thermal** - Vented fixture trim ring and fixture body maximize thermal performance and allow for a L70 lifetime rating of 50,000 hours. Fixture operating temperature: -4°F to 95°F (-20°C to 35°C).
- **Compliance and Warranty** – ETL listed for dry location. Canopy Mount is ETL listed for damp location. 5-year parts warranty for complete fixture. Designed for indoor use only. Not intended for outdoor applications. FCC certified per FCC 47CFR Part 15b consumer limits.



082622



BENEFITS

- Innovative, module design allows for field upgrades and replacements.
- Compact cylindrical form factor compliments existing architecture.
- Matte black and matte white finishes match existing track systems.
- H, J, and L track adapters with matching canopy mount available.
- Easy to install, snap-on true beam lenses and accessories available.

APPLICATIONS

- Retail
- Residential
- Hospitality
- Commercial
- Libraries and museums

LINE DRAWINGS

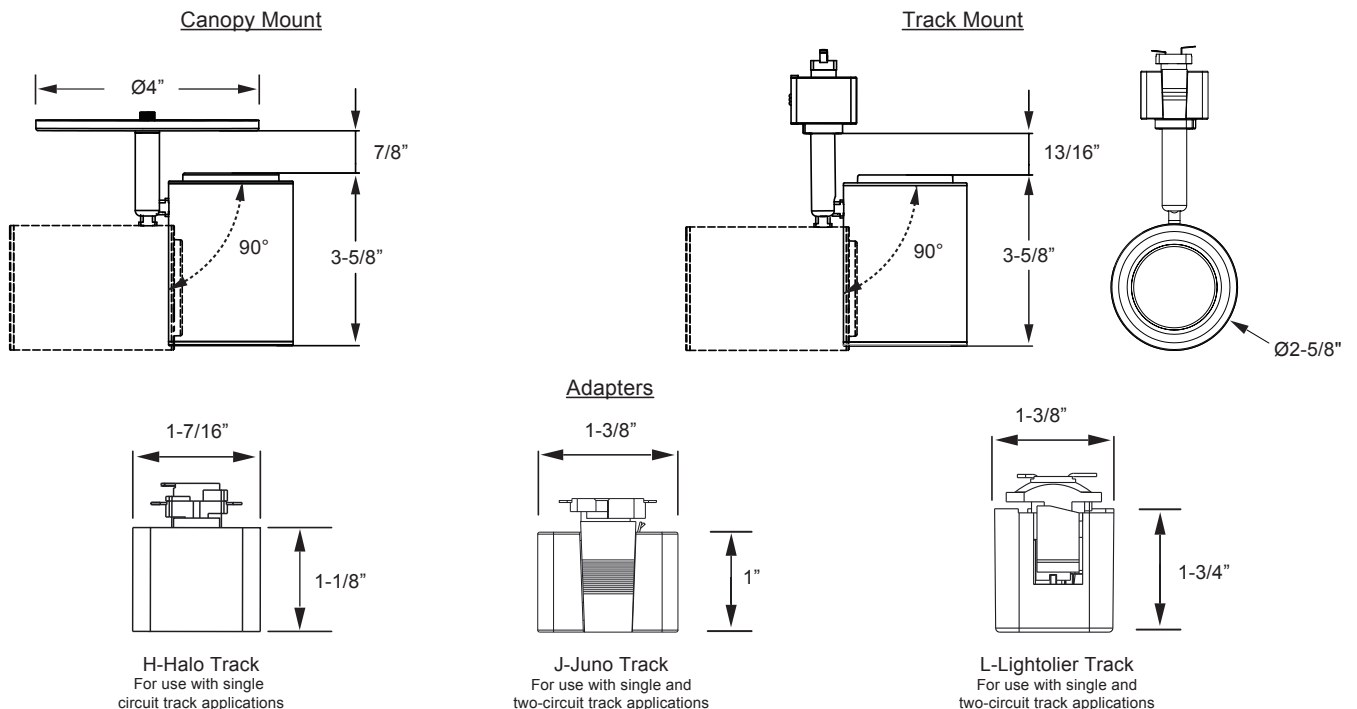



ATOM TRACK HEAD

ORDERING EXAMPLE

A complete fixture consists of Output, Adapter, CCT, Beam and Finish Selected

ATM6/930/NR/DIM120V/H/BL

ORDERING INFORMATION

Series	Output	CRI	CCT	Beam	DRIVER	Adapter	Finish
<input checked="" type="checkbox"/> ATM Atom Track Series	<input type="checkbox"/> 6 650 lumens	<input checked="" type="checkbox"/> 9 CRI 90+	<input type="checkbox"/> 27 2700K	<input type="checkbox"/> NR Narrow 25°	<input checked="" type="checkbox"/> DIM120V 120V, 50/60 Hz, Forward and Reverse Phase Line Voltage Dimming to 10%	<input type="checkbox"/> H Halo	<input type="checkbox"/> BL Matte Black
	<input type="checkbox"/> 10 1,050 lumens		<input type="checkbox"/> 30 3000K	<input type="checkbox"/> FL Flood 35°		<input type="checkbox"/> J Juno	<input type="checkbox"/> WH Matte White
			<input type="checkbox"/> 35 3500K			<input type="checkbox"/> L Lightolier	
			<input type="checkbox"/> 40 4000K			<input type="checkbox"/> CM Canopy Mount	

TECHNICAL INFORMATION

Series	Dimming	Input Voltage	Input Frequency	Input Power	THD Power	Power Factor
ATM6	120V, Forward and reverse phase dimming to 10%	120V	50 / 60Hz	7W	<20%	>0.9
ATM10	120V, Forward and reverse phase dimming to 10%	120V	50 / 60Hz	11.5W	<20%	>0.9

PHOTOMETRY

ATM6/930/NR/DIM120V/xx/yy

Lumens: 696lm
Power: 7W
Efficacy: 102lm/W
CRI: 90
CBCP: 3,160cd
Beam Angle: 25°

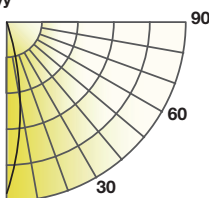

NARROW

Degree	Candela
0	3,160
5	3,578
15	2,109
25	262
35	77
45	18

ATM6/930/FL/DIM120V/xx/yy

Lumens: 688lm
Power: 7W
Efficacy: 101lm/W
CRI: 90
CBCP: 2,184cd
Beam Angle: 35°

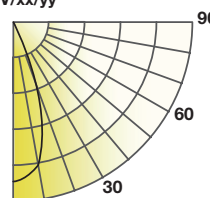

FLOOD

Degree	Candela
0	2,184
5	2,124
15	1,265
25	257
35	84
45	23

ATM10/930/NR/DIM120V/xx/yy

Lumens: 1,109lm
Power: 11W
Efficacy: 98lm/W
CRI: 90
CBCP: 5,171cd
Beam Angle: 25°

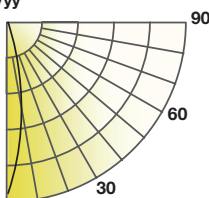

NARROW

Degree	Candela
0	5,171
5	4,678
15	1,328
25	374
35	131
45	44

ATM10/930/FL/DIM120V/xx/yy

Lumens: 1,105lm
Power: 11W
Efficacy: 98lm/W
CRI: 90
CBCP: 3,118cd
Beam Angle: 35°

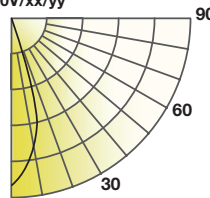

FLOOD

Degree	Candela
0	3,118
5	3,018
15	1,749
25	391
35	123
45	39

PERFORMANCE

CCT		2700K			3000K			3500K			4000K		
Series	Beam Angle	Output (lm)	Efficacy (lm/W)	CBCP (cd)	Output (lm)	Efficacy (lm/W)	CBCP (cd)	Output (lm)	Efficacy (lm/W)	CBCP (cd)	Output (lm)	Efficacy (lm/W)	CBCP (cd)
ATM6	Narrow 25°	651	95	3,250	696	102	3,160	696	102	3,160	699	102	3,739
	Flood 35°	672	98	2,112	688	101	2,184	688	101	2,184	719	105	2,316
ATM10	Narrow 25°	1,069	95	4,450	1,109	98	5,171	1,109	98	5,171	1,197	106	5,333
	Flood 35°	1,069	95	2,427	1,105	98	3,118	1,105	98	3,118	1,160	103	3,113



ATOM TRACK HEAD

PHOTOMETRY

Notes and Definitions:

D=Distance to floor or wall

FC=Footcandles on floor or wall at center beam location

L=Effective Visual Beam length in feet

W=Effective Visual Beam width in feet

X=In vertical aiming applications, (X) is the distance down to the center beam location

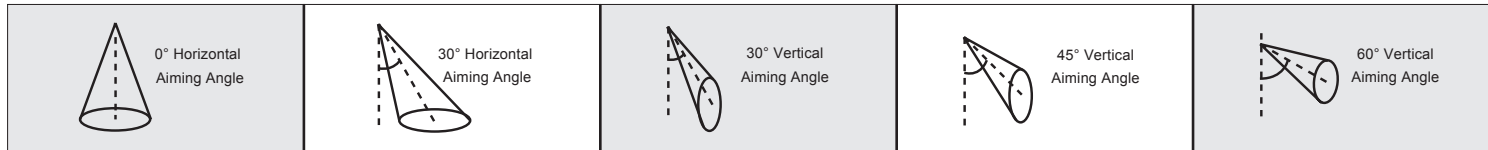
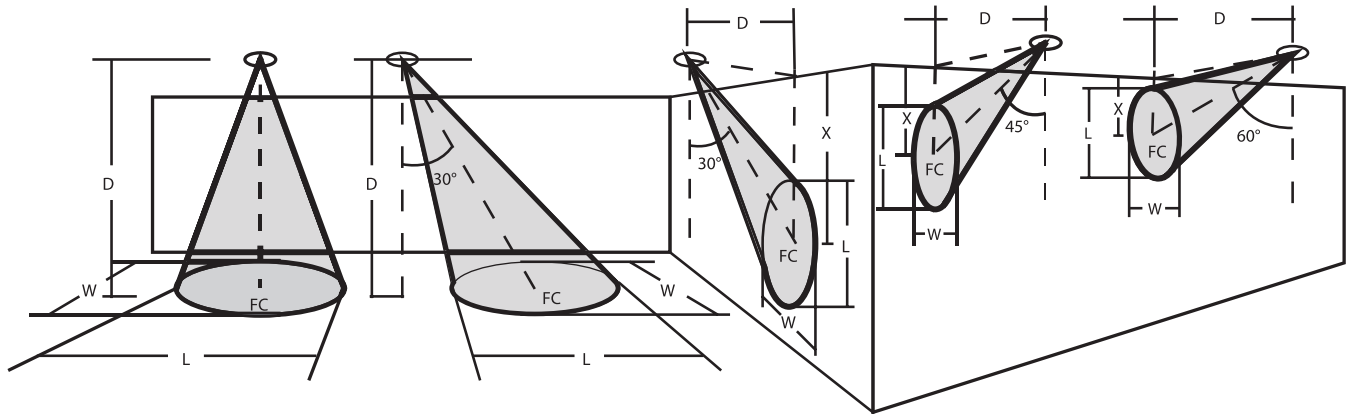

ATM6/930/NR/DIM120V/xx/yy Lumens: 696 Beam Angle: 25° CCT: 3000K CBCP: 3,160cd

D	FC	L	W	D	FC	L	W	D	X	FC	L	W	D	X	FC	L	W	D	X	FC	L	W
6	99	2.3	2.3	6	75	3.0	2.6	3	5.2	99	5.0	2.3	3	3.0	199	2.3	1.3	6	3.5	75	3.0	2.6
8	56	3.0	3.0	8	42	4.1	3.5	4	6.9	56	6.7	3.0	4	4.0	112	3.1	1.7	8	4.6	42	4.1	3.5
10	36	3.8	3.8	10	27	5.1	4.3	5	8.7	36	8.4	3.8	5	5.0	72	3.9	2.2	10	5.8	27	5.1	4.3
12	25	4.5	4.5	12	19	6.1	5.2	6	10.4	25	10.1	4.5	6	6.0	50	4.7	2.6	12	6.9	19	6.1	5.2
14	18	5.3	5.3	14	14	7.1	6.1	7	12.1	18	11.8	5.3	7	7.0	37	5.5	3.0	14	8.1	14	7.1	6.1

ATM6/930/FL/DIM120V/xx/yy Lumens: 688 Beam Angle: 35° CCT: 3000K CBCP: 2,184cd

D	FC	L	W	D	FC	L	W	D	X	FC	L	W	D	X	FC	L	W	D	X	FC	L	W
6	61	3.3	3.3	6	46	4.5	3.8	3	5.2	61	8.5	3.3	3	3.0	123	3.6	1.9	6	3.5	46	4.5	3.8
8	35	4.4	4.4	8	26	6.0	5.1	4	6.9	34	11.4	4.4	4	4.0	69	4.8	2.5	8	4.6	26	6.0	5.1
10	22	5.5	5.5	10	17	7.5	6.3	5	8.7	22	14.2	5.5	5	5.0	44	5.9	3.2	10	5.8	17	7.5	6.3
12	15	6.6	6.6	12	12	9.0	7.6	6	10.4	15	17.0	6.6	6	6.0	31	7.1	3.8	12	6.9	11	9.0	7.6
14	11	7.7	7.7	14	8	10.5	8.9	7	12.1	11	19.9	7.7	7	7.0	23	8.3	4.4	14	8.1	8	10.5	8.9

ATM10/930/NR/DIM120V/xx/yy Lumens: 1,109 Beam Angle: 25° CCT: 3000K CBCP: 5,171cd

D	FC	L	W	D	FC	L	W	D	X	FC	L	W	D	X	FC	L	W	D	X	FC	L	W
6	1145.8	2.2	2.2	6	109	2.9	2.5	3	5.2	146	4.8	2.2	3	3.0	292	2.2	1.2	6	3.5	109	2.9	2.5
8	82.0	2.9	2.9	8	62	3.9	3.3	4	6.9	82	6.4	2.9	4	4.0	164	3.0	1.7	8	4.6	62	3.9	3.3
10	52.5	3.6	3.6	10	39	4.9	4.2	5	8.7	52	8.0	3.6	5	5.0	105	3.7	2.1	10	5.8	39	4.9	4.2
12	36.5	4.3	4.3	12	27	5.8	5.0	6	10.4	36	9.6	4.3	6	6.0	73	4.5	2.5	12	6.9	27	5.8	5.0
14	26.8	5.0	5.0	14	20	6.8	5.8	7	12.1	27	11.2	5.0	7	7.0	54	5.2	2.9	14	8.1	20	6.8	5.8











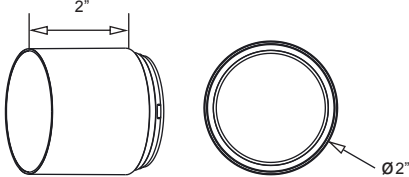

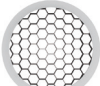
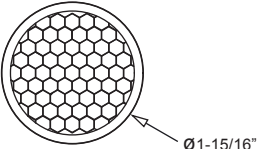

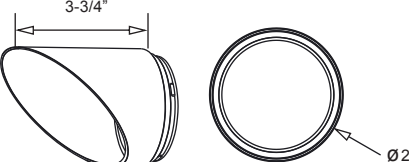

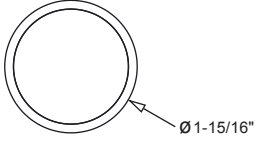

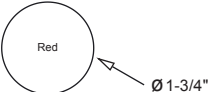
ATM10/930/FL/DIM120V/xx/yy Lumens: 1,105 Beam Angle: 35° CCT: 3000K CBCP: 3,118cd

D	FC	L	W	D	FC	L	W	D	X	FC	L	W	D	X	FC	L	W	D	X	FC	L	W
6	87	3.4	3.4	6	65	4.7	4.0	3	5.2	87	9.1	3.4	3	3.0	174	3.7	2.0	6	3.5	65	4.7	4.0
8	49	4.6	4.6	8	37	6.3	5.3	4	6.9	49	12.1	4.6	4	4.0	98	5.0	2.6	8	4.6	37	6.3	5.3
10	31	5.7	5.7	10	24	7.8	6.6	5	8.7	31	15.1	5.7	5	5.0	63	6.2	3.3	10	5.8	24	7.8	6.6
12	22	6.9	6.9	12	16	9.4	7.9	6	10.4	22	18.2	6.9	6	6.0	44	7.5	4.0	12	6.9	16	9.4	7.9
14	16	8.0	8.0	14	12	11.0	9.2	7	12.1	16	21.2	8.0	7	7.0	32	8.7	4.6	14	8.1	12	11.0	9.2





ATOM TRACK HEAD

ACCESSORY ORDERING INFORMATION

Product	Model	Description	Pictures	Dimensions
35037	ATM/A/SN/WH	Snoot: Matte White		
35038	ATM/A/SN/BL	Snoot: Matte Black		
35040	ATM/A/HC/WH	Honeycomb Louver: Matte White Ring		
35041	ATM/A/HC/BL	Honeycomb Louver: Matte Black Ring		
35043	ATM/A/WW/WH	Wall Wash: Matte White		
35044	ATM/A/WW/BL	Wall Wash: Matte Black		
36859	ATM/A/RING/WH	Lens Holder Ring Matte White		
36860	ATM/A/RING/BL	Lens Holder Ring Matte Black		
35811	MR/ACC/RED	Color lens - Red To be used with Lens Holder, Snoot, or Wall Wash		
35812	MR/ACC/GRE	Color lens - Green To be used with Lens Holder, Snoot, or Wall Wash		
35813	MR/ACC/BLE	Color lens - Blue To be used with Lens Holder, Snoot, or Wall Wash		
35814	MR/ACC/YLW	Color lens - Yellow To be used with Lens Holder, Snoot, or Wall Wash		
35818	MR/ACC/SQ2525	Square distribution lens 25° to use with NR Beam To be used with Lens Holder, Snoot, or Wall Wash		
35819	MR/ACC/SQ3636	Square distribution lens 36° to use with FL Beam To be used with Lens Holder, Snoot, or Wall Wash		

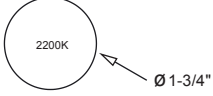
ATOM TRACK HEAD

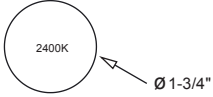
ACCESSORY ORDERING INFORMATION				
Product	Model	Description	Pictures	Dimenions
35809	MR/ACC/CCT22	Shift lens 2200K		
35810	MR/ACC/CCT24	Shift lens 2400K		

SQUARE LENS

Provides a square shaped light distribution.

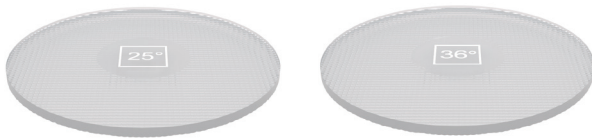

Product	Model	Lumen Transmissivity	CBCP	Field Angle
35818	MR/ACC/SQ2525	80%	19%	25°
35819	MR/ACC/SQ3636	80%	11%	36°



ILLUMINANCE & CANDELA DISTRIBUTION

ATM6/930/NR/DIM120V/xx/yy
+ ATM/A/RING/yy + MR/ACC/SQ2525

Lumens: 576lm
Power: 7W
Efficacy: 82lm/W
CRI: 90
CBCP: 1555cd
Beam Angle: 26°

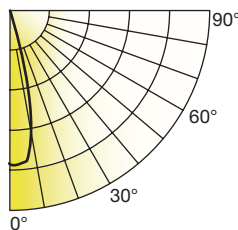

Angle (°)	Average (cd)
0	1,541
5	1,506
15	805
25	221
35	114
45	47

Note: All rights reserved. All sizes and specifications are subject to change at any time without notice.