

Project Name:	Type:
Part Number:	Date:



GREENCREATIVE

# HID POST TOP LAMP

## FEATURES

- Integral driver suitable for 120-277V
- Replaces 175W / 250W / 400W HID
- Fully omnidirectional 320° beam angle
- Field adjustable lumen output using integral rotary control
- Suitable for use in totally enclosed fixtures\*
- Suitable for damp locations
- Integral thermal sensor reduces power to the lamp in the event ambient temperature exceeds specified limitations
- Lamp ambient temperature: -4°F to 122°F (-20°C to 50°C)
- Fixture operating temperature: -13°F to 113°F (-25°C to 45°C)
- Rated lifetime (L70): 50,000hrs
- 5 year limited warranty\*\*
- Integral 6kV surge protector
- Supplied with safety cable to provide secondary support

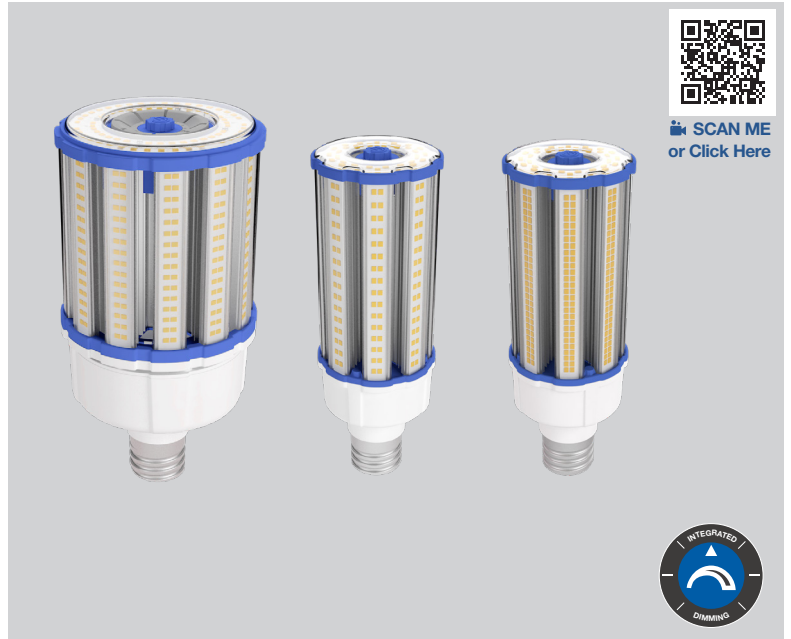

060523



## FOCUS FEATURE

Integral dimming control allows light output to be tailored to application requirements and can be adjusted from 0-100% with no additional wiring or controls needed.

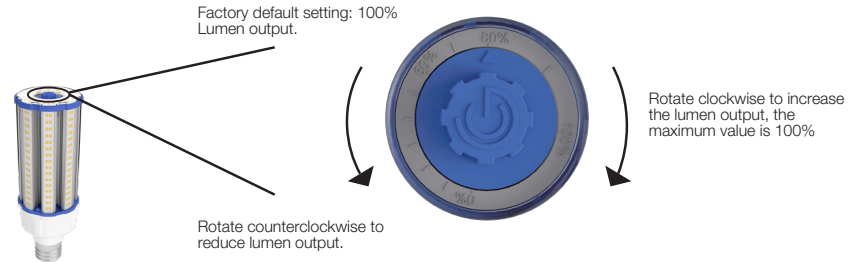

Model	CCT	Step Wattage	Lumen	LPW
54HID/8xx/277V/EX39/RC	4000K 5000K	60%-32.4W	4,620	143
		80%-43.2W	6,160	143
		100%-54W	7,700	143
63HID/8xx/277V/EX39/RC	4000K 5000K	60%-37.8W	5,700	151
		80%-50.4W	7,600	151
		100%-63W	9,500	151
100HID/8xx/277V/EX39/RC	4000K 5000K	60%-60W	8,700	145
		80%-80W	11,600	145
		100%-100W	14,500	145

Where xx means color temperature

## SPECIFICATIONS

Product	Model	Equiv. (HID)	Input Voltage	Wattage	Lumens (lm)	CCT	CRI	Efficacy (LPW)	Beam Angle	Power Factor	THD	Fixture Rating	DLC
35887	54HID/840/277V/EX39/RC	175-250W	120-277V	54	7,700	4000K	82	143	320°	0.9	<20%	Enclosed	✓
35888	54HID/850/277V/EX39/RC	175-250W	120-277V	54	7,700	5000K	82	143	320°	0.9	<20%	Enclosed	✓
35889	63HID/840/277V/EX39/RC	175-250W	120-277V	63	9,500	4000K	82	150	320°	0.9	<20%	Enclosed	✓
35890	63HID/850/277V/EX39/RC	175-250W	120-277V	63	9,500	5000K	82	150	320°	0.9	<20%	Enclosed	✓
35891	100HID/840/277V/EX39/RC	250-400W	120-277V	100	14,500	4000K	82	145	320°	0.9	<20%	Enclosed	✓
35892	100HID/850/277V/EX39/RC	250-400W	120-277V	100	14,500	5000K	82	145	320°	0.9	<20%	Enclosed	✓

\*\* Please visit [www.greencreative.com](http://www.greencreative.com) for Limited Warranty terms.



# HID POST TOP LAMP

## DIMENSION & WEIGHT

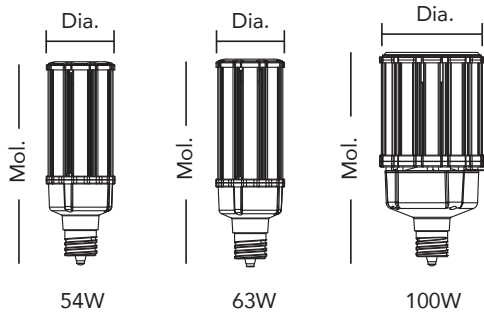

Model	Base	Mol.	Dia.	Weight
54HID/xxx/277V/EX39/RC	EX39	9-15/16"	3-5/16"	1.58 lb
63HID/xxx/277V/EX39/RC	EX39	10-1/4"	3-5/16"	1.60 lb
100HID/xxx/277V/EX39/RC	EX39	10-7/16"	5-1/8"	3.15 lb

Where xxx means 824-965 which indicates CRI and color temperature

## ORDERING INFORMATION

Product Series	Shipping Carton		
	Case Qty	Case Dimensions (LxWxH)	Case Weight
HID 54W EX39 Lamps	12PCS	15-1/8" x 11-13/16" x 12-1/4"	23.57 lb
HID 63W EX39 Lamps	12PCS	15-1/8" x 11-13/16" x 12-5/8"	23.96 lb
HID 100W EX39 Lamps	6PCS	16-9/16" x 11-7/16" x 12-5/8"	24.67 lb

## CERTIFICATION INFORMATION

Product	Model No.	General Application	DLC ID#
35887	54HID/840/277V/EX39/RC	Mid Output	PLGL1N8K4MK4
35888	54HID/850/277V/EX39/RC	Mid Output	PL60SLIB9P17
35889	63HID/840/277V/EX39/RC	Mid Output	PL7TXNCOG0ZN
35890	63HID/850/277V/EX39/RC	Mid Output	PLB5KMAWS9IR
35891	100HID/840/277V/EX39/RC	High-Bay	PL8KQXEK9GHB
35891	100HID/840/277V/EX39/RC	High Output	PL3PDO4NZ12D
35892	100HID/850/277V/EX39/RC	High-Bay	PL0ETEJXIH6J
35892	100HID/850/277V/EX39/RC	High Output	PLMX54A77AUD

## \*MINIMUM COMPARTMENT DIMENSIONS ( FOR ENCLOSED FIXTURES )



Vertical Installation	Model	Length	Width	Height
	54HID/xxx/277V/EX39/RC	9-1/16"	9-1/16"	26-1/2"
	63HID/xxx/277V/EX39/RC	10-1/4"	10-1/4"	27-1/4"
	100HID/xxx/277V/EX39/RC	10-1/4"	10-1/4"	27-1/4"
Horizontal Installation	Model	Length	Width	Height
	54HID/xxx/277V/EX39/RC	16-15/16"	9-1/16"	11-1/16"
	63HID/xxx/277V/EX39/RC	16-15/16"	9-1/16"	11-1/16"
	100HID/xxx/277V/EX39/RC	16-15/16"	9-1/16"	11-1/16"

\*Installing lamp in a fixture that does not have the minimum compartment dimensions will void the warranty and could cause product failures.

## SUPPLIED ACCESSORY

Description	Picture	Length
Safety Cable		11-7/8"

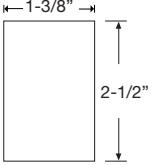
# HID POST TOP LAMP

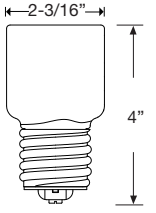
OPTIONAL ACCESSORY ORDERING INFORMATION				
Product	Model	Description	Picture	Dimensions
97718	10SURGE/277V	10KV Surge Protector Recommended for use in Area light retrofits and other applications subject to high surge conditions.		
35050	E39 EXTENDER	EX39 Lamp Extender Adds 1-11/16" to Lamp Height		

Note: All rights reserved. All sizes and specifications are subject to change at any time without notice.