

Project Name:	Type:
Part Number:	Date:

SINGLE CIRCUIT J-TYPE TRACK SYSTEM

SPECIFICATION FEATURES

- Mechanical** - Extruded aluminum, I-beam construction for strength and rigidity in pendant or suspended applications. One-piece integrated thermoplastic insulator. Two 12 gauge solid copper conductors. One injection molded polycarbonate dead-end with set screw provided with each track section. Stainless steel toggle bolts included with each track section for surface mount installation. Field-cutable for custom lengths. Comes in White, Black or Silver finish.
- Electrical** - Rated for 20A at 120V, 60Hz. Maximum power rating is 2.4kW. NEC allows 80% of full capacity or 1.92kW. Mechanical polarity with a visual indicator simplifies installation, mounting and proper connection.
- Compliance and Warranty** - All track and track components are cULus listed for dry location. RoHS-compliant. Compatible with ATOM and ORBIT GREEN CREATIVE track fixture, Single Circuit, J-type adapter. 1 year parts warranty for complete system.

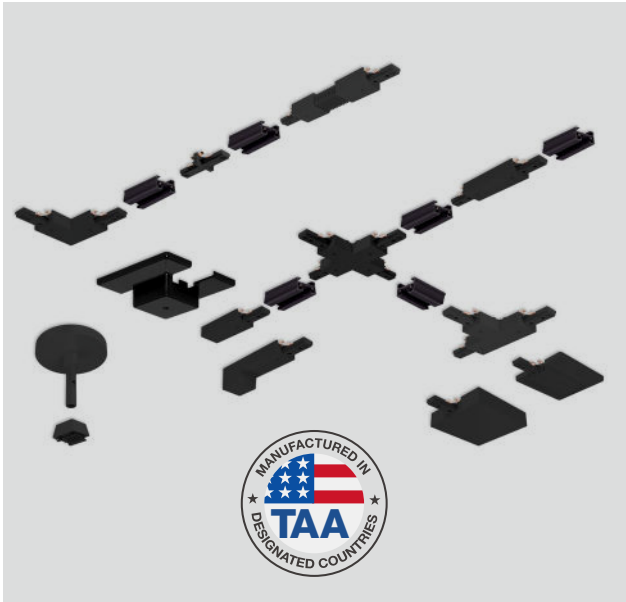

042123

BENEFITS

- GREEN CREATIVE Single Circuit J-Type Track System is compatible with all GREEN CREATIVE Track Fixtures with J-type adapter.
- Compatible with a full range of feed and connector to complete virtually any configuration.
- A full set of mounting accessories are available for surface or pendant mounting to fit any type of ceiling.

APPLICATIONS

- Retail
- Commercial
- Museum and Art Galleries
- Showrooms
- Residential

ORDERING INFORMATION

Series	Length	Circuit	Finish
<input checked="" type="checkbox"/> TRKJ Track J-type	<input type="checkbox"/> 24 24in. (2ft) Length	<input checked="" type="checkbox"/> 1C Single Circuit	<input type="checkbox"/> BL Black
	<input type="checkbox"/> 48 48in. (4ft) Length		<input type="checkbox"/> WH White
	<input type="checkbox"/> 96 96in. (8ft) Length		<input type="checkbox"/> SV Silver

LINE DRAWINGS

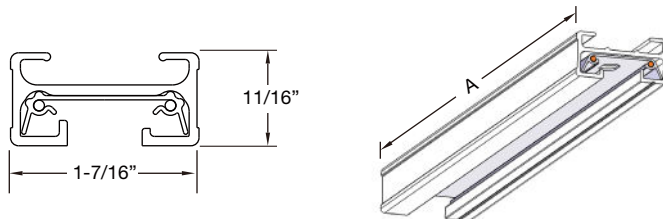

Nominal Length	Exact Length A
24in. / 2ft.	20-1/8"
48in. / 4ft.	44-1/8"
96in. / 8ft.	92-1/8"



SINGLE CIRCUIT J-TYPE TRACK SYSTEM

SINGLE CIRCUIT J-TYPE TRACK SYSTEM - POWER FEEDS

Top Access End Feed:

Ordering example: TRKJ/ENDF/1C/WH

For direct wiring through ceiling with junction box or end feed in suspension, cover plate is required over junction box. Accepts 3/8" or 1/2" (trade size) electrical fittings.



Series	Type	Circuit	Finish
<input checked="" type="checkbox"/> TRKJ Track J-type	<input checked="" type="checkbox"/> ENDF Live End Feed	<input checked="" type="checkbox"/> 1C Single Circuit	<input type="checkbox"/> BL Black
			<input type="checkbox"/> WH White
			<input type="checkbox"/> SV Silver

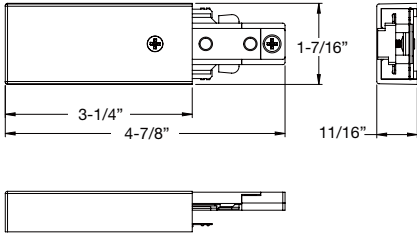

Surface Conduit End Feed:

Ordering example: TRKJ/SCF/1C/WH

For surface conduit wiring. Accepts 3/8" or 1/2" (trade size) electrical fittings.



Series	Type	Circuit	Finish
<input checked="" type="checkbox"/> TRKJ Track J-type	<input checked="" type="checkbox"/> SCF Surface Conduit Feed	<input checked="" type="checkbox"/> 1C Single Circuit	<input type="checkbox"/> BL Black
			<input type="checkbox"/> WH White
			<input type="checkbox"/> SV Silver

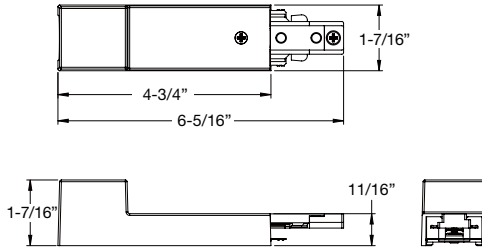

End Feed with Cover:

Ordering example: TRKJ/ENDFCOV/1C/WH

For Wiring through junction box, located at one end of the track section. Built-in junction box cover.



Series	Type	Circuit	Finish
<input checked="" type="checkbox"/> TRKJ Track J-type	<input checked="" type="checkbox"/> ENDFCOV End Feed with Cover	<input checked="" type="checkbox"/> 1C Single Circuit	<input type="checkbox"/> BL Black
			<input type="checkbox"/> WH White
			<input type="checkbox"/> SV Silver

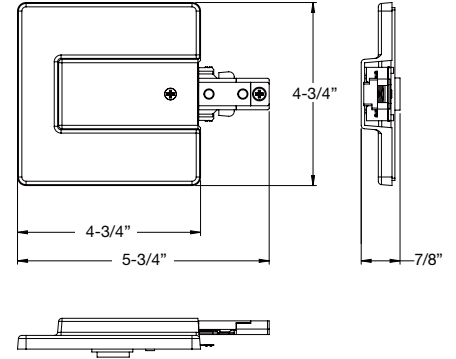

Floating Canopy Feed:

Ordering example: TRKJ/FCPY/1C/WH

For wiring through junction box. Can be located anywhere along track section.



Series	Type	Circuit	Finish
<input checked="" type="checkbox"/> TRKJ Track J-type	<input checked="" type="checkbox"/> FCPY Floating Canopy Feed	<input checked="" type="checkbox"/> 1C Single Circuit	<input type="checkbox"/> BL Black
			<input type="checkbox"/> WH White
			<input type="checkbox"/> SV Silver

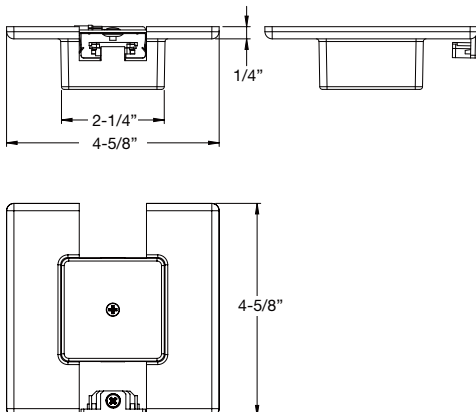

T-Bar End Feed:

Ordering example: TRKJ/TBENDF/1C/WH

Direct wiring through ceiling tile with junction box when T-Bar is directly above track. Accepts 3/8" or 1/2" (trade size) electrical fittings.



Series	Type	Circuit	Finish
<input checked="" type="checkbox"/> TRKJ Track J-type	<input checked="" type="checkbox"/> TBENDF T-Bar End Feed	<input checked="" type="checkbox"/> 1C Single Circuit	<input type="checkbox"/> BL Black
			<input type="checkbox"/> WH White
			<input type="checkbox"/> SV Silver

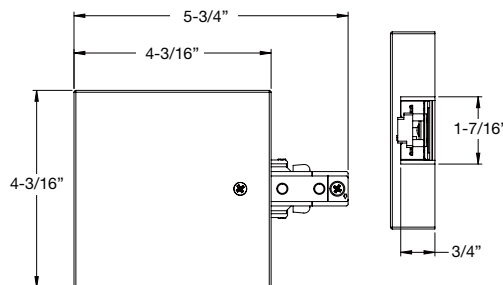

End Cap:

Ordering example: TRKJ/END/1C/WH

Covers end of track section. One included with each track section.



Series	Type	Circuit	Finish
<input checked="" type="checkbox"/> TRKJ Track J-type	<input checked="" type="checkbox"/> END End Cap	<input checked="" type="checkbox"/> 1C Single Circuit	<input type="checkbox"/> BL Black
			<input type="checkbox"/> WH White
			<input type="checkbox"/> SV Silver

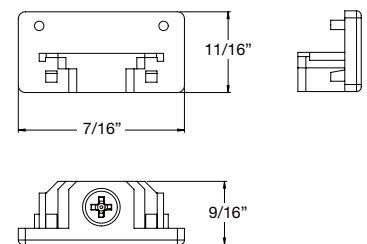



SINGLE CIRCUIT J-TYPE TRACK SYSTEM

SINGLE CIRCUIT J-TYPE TRACK SYSTEM - CONNECTORS

Mini I Connector:

Ordering example: TRKJ/MIC/1C/BL
Connects two track sections end to end.
Low profile design for a clean continuous run.
Cannot be used as feed point.



I Connector:

Ordering example: TRKJ/IC/1C/BL
Connects two track sections end to end.
May be used as feed point, cover plate is
required over junction box.



I Flexible Connector:

Ordering example: TRKJ/IFC/1C/BL
Connects two track sections end to end.
May be used as feed point, cover plate is
required over junction box.



Series	Type	Circuit	Finish
<input checked="" type="checkbox"/> TRKJ Track J-type	<input checked="" type="checkbox"/> MIC Mini I Connector	<input checked="" type="checkbox"/> 1C Single Circuit	<input type="checkbox"/> BL Black
			<input type="checkbox"/> WH White
			<input type="checkbox"/> SV Silver

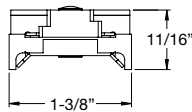
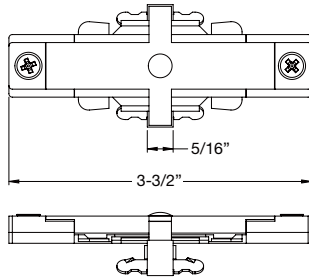

Series	Type	Circuit	Finish
<input checked="" type="checkbox"/> TRKJ Track J-type	<input checked="" type="checkbox"/> IC I Connector	<input checked="" type="checkbox"/> 1C Single Circuit	<input type="checkbox"/> BL Black
			<input type="checkbox"/> WH White
			<input type="checkbox"/> SV Silver

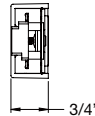
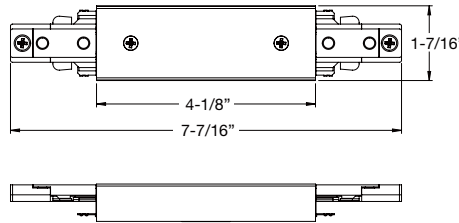

Series	Type	Circuit	Finish
<input checked="" type="checkbox"/> TRKJ Track J-type	<input checked="" type="checkbox"/> IFC I Flex Connector	<input checked="" type="checkbox"/> 1C Single Circuit	<input type="checkbox"/> BL Black
			<input type="checkbox"/> WH White
			<input type="checkbox"/> SV Silver

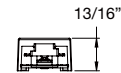
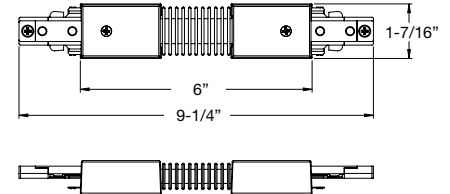

L Connector:

Ordering example: TRKJ/LC/1C/BL
Connects two track sections end to end in
a 90° angle configuration. May be used as
feed point, cover plate is required over
junction box.



T Connector:

Ordering example: TRKJ/TC/1C/BL
Connects three track sections in a T
shape configuration. Reverse polarity
available (*R*). May be used as feed
point, cover plate is required over
junction box.



X Connector:

Ordering example: TRKJ/XC/1C/BL
Connects four track sections in an X
configuration. Factory wired for two
separate 90° runs. May be field wired for
one run. May be used as feed point,
cover plate is required over junction box.



Series	Type	Circuit	Finish
<input checked="" type="checkbox"/> TRKJ Track J-type	<input checked="" type="checkbox"/> LC L Connector	<input checked="" type="checkbox"/> 1C Single Circuit	<input type="checkbox"/> BL Black
			<input type="checkbox"/> WH White
			<input type="checkbox"/> SV Silver

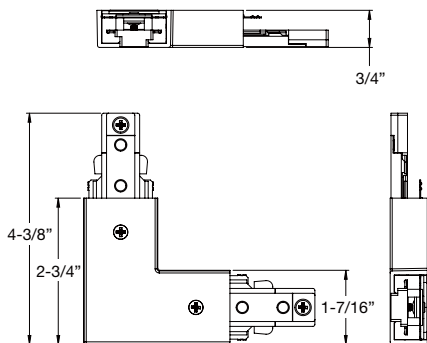

Series	Type	Circuit	Finish
<input checked="" type="checkbox"/> TRKJ Track J-type	<input type="checkbox"/> TC T Connector	<input checked="" type="checkbox"/> 1C Single Circuit	<input type="checkbox"/> BL Black
	<input type="checkbox"/> TCR T Connector Reverse Polarity		<input type="checkbox"/> WH White
			<input type="checkbox"/> SV Silver

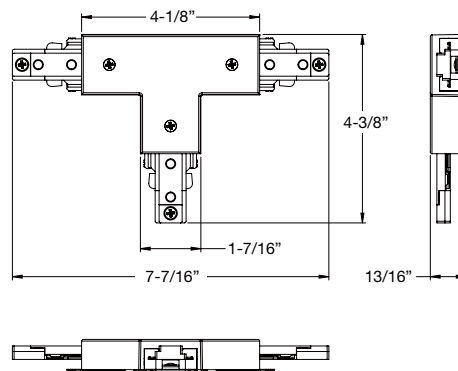

Series	Type	Circuit	Finish
<input checked="" type="checkbox"/> TRKJ Track J-type	<input checked="" type="checkbox"/> XC X Connector	<input checked="" type="checkbox"/> 1C Single Circuit	<input type="checkbox"/> BL Black
			<input type="checkbox"/> WH White
			<input type="checkbox"/> SV Silver

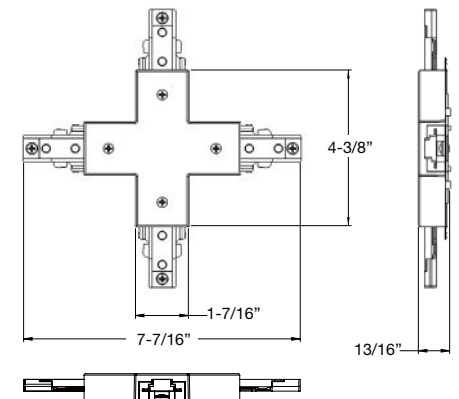



SINGLE CIRCUIT J-TYPE TRACK SYSTEM

SINGLE CIRCUIT J-TYPE TRACK SYSTEM - COVER PLATE

Square Cover Plate:

Ordering example: TRK/COVPLATE/BL
 Square Cover Plate with threaded center access hole. Includes ground washer, threaded nipple and nut. For use with I, L, T and X connectors.
 Covers standard 4" octagonal J-Box.

Series	Type	Finish
<input checked="" type="checkbox"/> TRK Track	<input checked="" type="checkbox"/> COVPLATE Square cover plate	<input type="checkbox"/> BL Black
		<input type="checkbox"/> WH White
		<input type="checkbox"/> SV Silver

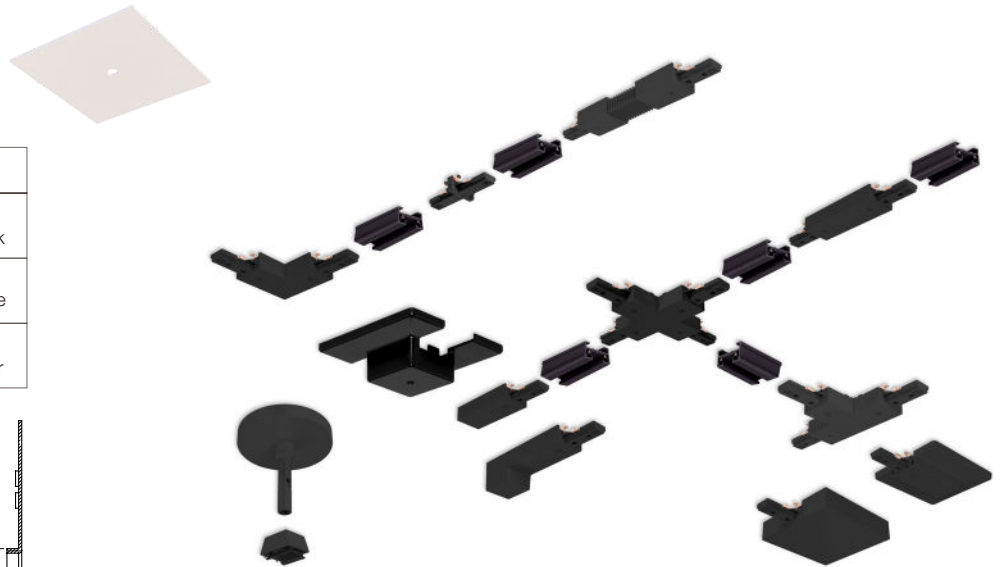
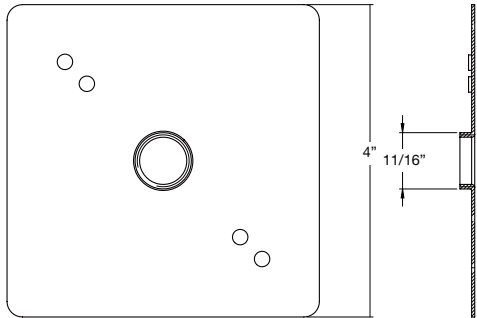

SINGLE CIRCUIT J-TYPE TRACK SYSTEM - MOUNTING AND SUSPENSION

Suspension Canopy:

Ordering example: TRK/STCPY/BL
 Suspend track from ceiling or junction box. Includes canopy and track bracket. Stem not included. Suspension stem available to be ordered separately.



Series	Type	Finish
<input checked="" type="checkbox"/> TRK Track	<input checked="" type="checkbox"/> STCPY Stem Canopy	<input type="checkbox"/> BL Black
		<input type="checkbox"/> WH White
		<input type="checkbox"/> SV Silver

Slope Ceiling Canopy:

Ordering example: TRK/STEMSLOPECPY/BL
 Suspend track from slope ceiling or junction box. Includes canopy, swivel adapter and track bracket. Stem not included. Suspension stem available to be ordered separately.



Series	Type	Finish
<input checked="" type="checkbox"/> TRK Track	<input checked="" type="checkbox"/> STEMSLOPECPY Stem Slope Ceiling Canopy	<input type="checkbox"/> BL Black
		<input type="checkbox"/> WH White
		<input type="checkbox"/> SV Silver

Stem:

Ordering example: STEM/1-4/12/BL
 1/4" IPS Suspension Stems (Iron Pipe Standard). 1/2" O.D. 3/4" x 3/4"
 Threaded at each end. 18 Threads per Inch, 16 Gauge. May be extended using stem coupling.



Series	IPS	Type	Finish
<input checked="" type="checkbox"/> STEM	<input checked="" type="checkbox"/> 1-4 1/4" IPS	<input type="checkbox"/> 12 12" long	<input type="checkbox"/> BL Black
		<input type="checkbox"/> 24 24" long	<input type="checkbox"/> WH White
		<input type="checkbox"/> 36 36" long	<input type="checkbox"/> SV Silver
		<input type="checkbox"/> 48 48" long	

*Silver stem might be subjected to longer lead time, please contact us for lead time inquiry.

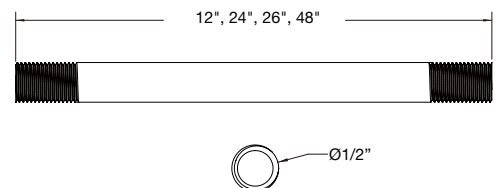
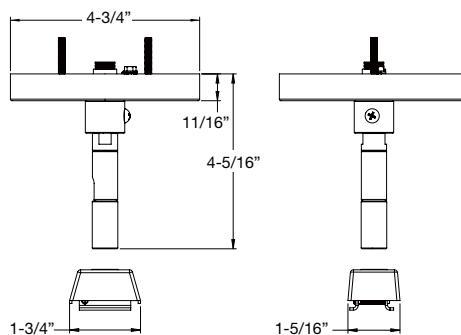
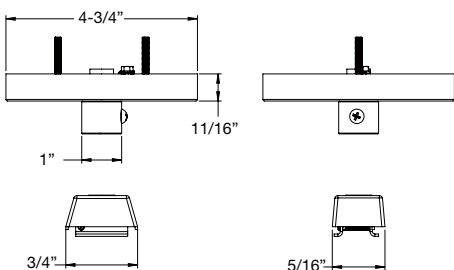



SINGLE CIRCUIT J-TYPE TRACK SYSTEM

SINGLE CIRCUIT J-TYPE TRACK SYSTEM - MOUNTING AND SUSPENSION

Stem Coupling:

Ordering example: STEM1-4/COUPLING/BL
Connects two suspension 1-4 IPS stems to extend the drop.



Wire Way Cover:

Ordering example: TRK/SWIRCOV/BL
Conceals electrical feed wire from stem to end feed.



T-Bar Mounting Clip:

Ordering example: TRK/TBMOUNTCLIP
Slide-on Type T-Bar Mounting Clip for flush tile ceiling. Use two for 2ft or 4ft section. Use 3 for 8ft.



Series	Type	Finish
<input checked="" type="checkbox"/> STEM1-4 1/4" IPS Stem	<input checked="" type="checkbox"/> COUPLING Coupling Extender	<input type="checkbox"/> BL Black
		<input type="checkbox"/> WH White
		<input type="checkbox"/> SV* Silver

Series	Type	Finish
<input checked="" type="checkbox"/> TRK Track	<input checked="" type="checkbox"/> SWIRCOV Wire Way Cover	<input type="checkbox"/> BL Black
		<input type="checkbox"/> WH White
		<input type="checkbox"/> SV Silver

Series	Type
<input checked="" type="checkbox"/> TRK Track	<input checked="" type="checkbox"/> TBMOUNTCLIP Slide-on T-bar mounting clip

*Silver stem coupling might be subjected to longer lead time, please contact us for lead time inquiry.

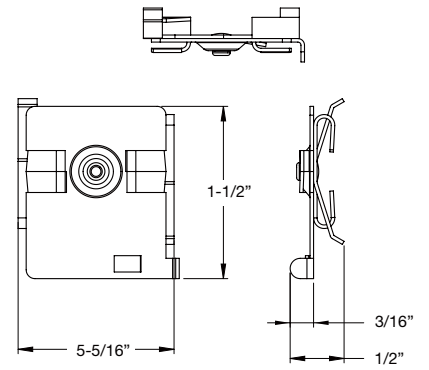
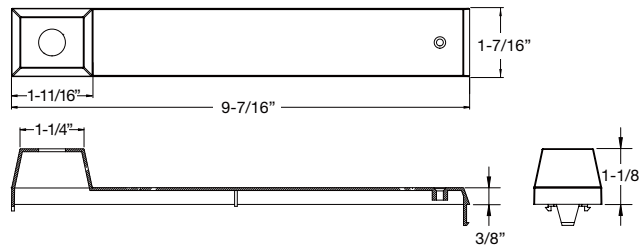
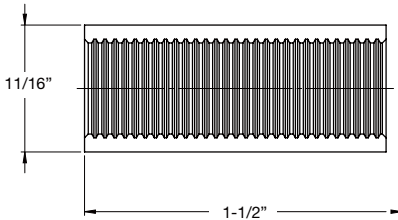

EXAMPLE OF TRACK SYSTEM INSTALLATION (TOP PLAN VIEW)

Shaded area: Hot side of track system

- : Straight section of track (TRKJ/xx/1C/yy)
- : End Cap of track section (TRKJ/END/1C/yy)

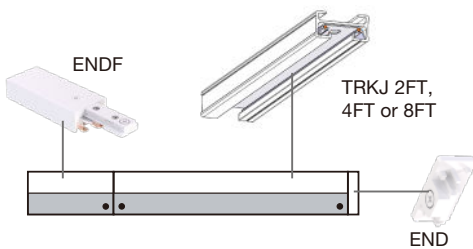

Linear run with end feed connection

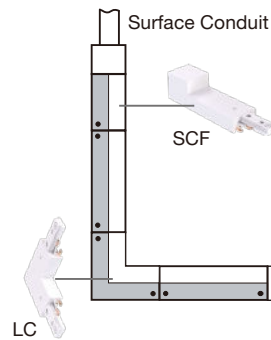

L type run with surface conduit connection

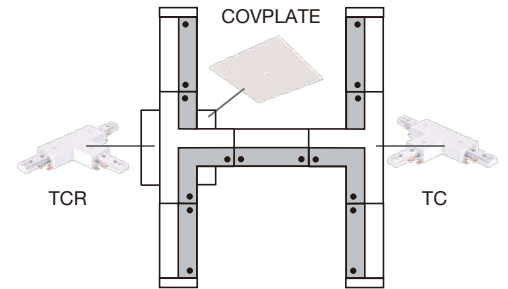

H type run connection from T connector

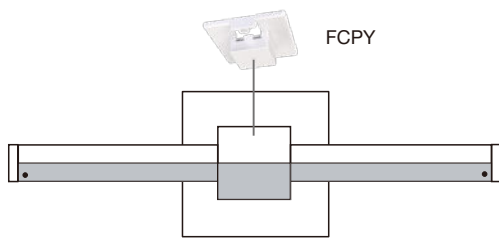

Linear run connection with middle connection through Jbox

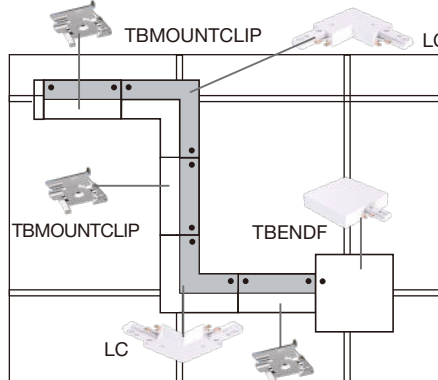

S type run with T-bar ceiling end feed

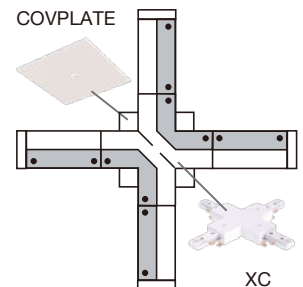

Cross type run with connection from X connector



SINGLE CIRCUIT J-TYPE TRACK SYSTEM

EXAMPLE OF TRACK SYSTEM INSTALLATION (TOP PLAN VIEW)

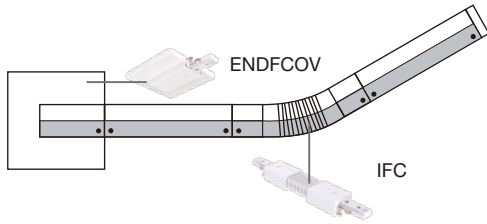

Curved run with surface Jbox connection

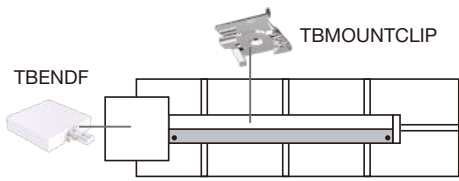

Linear run with T-Bar ceiling end feed

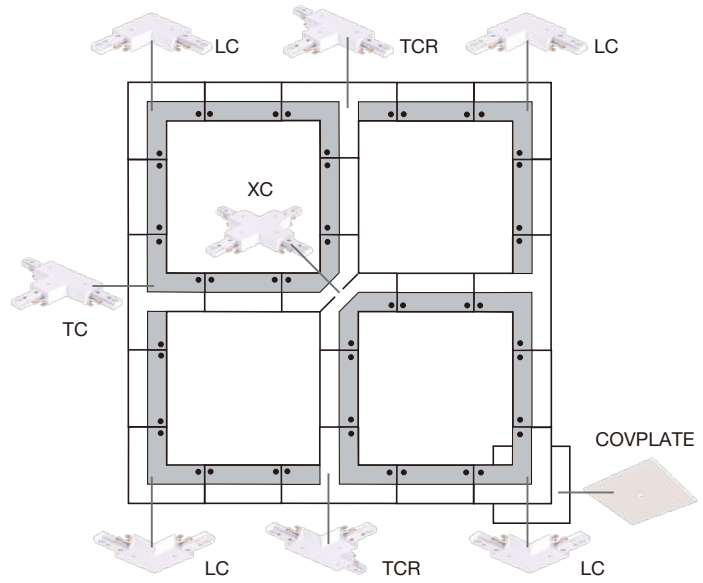

Loop type run with connection from L connector

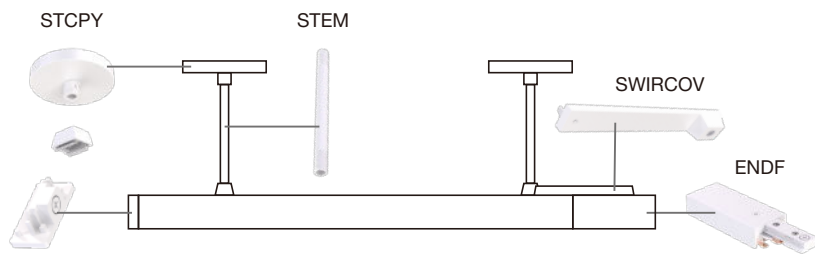

Pendant Mount Installation - Straight Ceiling (side view)

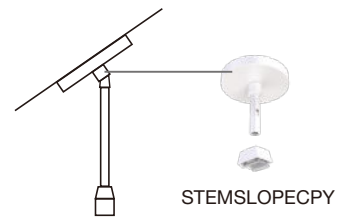

Pendant Mount Installation - Slope Ceiling (front side view)



SINGLE CIRCUIT J-TYPE TRACK SYSTEM











ORDERING GUIDE

Product	Model	Description	Picture
35716	TRKJ/24/1C/WH	24" Single Circuit J-Type Track, White	
35719	TRKJ/48/1C/WH	48" Single Circuit J-Type Track, White	
35725	TRKJ/96/1C/WH	96" Single Circuit J-Type Track, White	
35717	TRKJ/24/1C/BL	24" Single Circuit J-Type Track, Black	
35720	TRKJ/48/1C/BL	48" Single Circuit J-Type Track, Black	
35726	TRKJ/96/1C/BL	96" Single Circuit J-Type Track, Black	
35718	TRKJ/24/1C/SV	24" Single Circuit J-Type Track, Silver	
35721	TRKJ/48/1C/SV	48" Single Circuit J-Type Track, Silver	
35727	TRKJ/96/1C/SV	96" Single Circuit J-Type Track, Silver	
35728	TRKJ/MIC/1C/WH	Single Circuit J-Type Track Mini-I Connector, White	
35729	TRKJ/MIC/1C/BL	Single Circuit J-Type Track Mini-I Connector, Black	
35730	TRKJ/MIC/1C/SV	Single Circuit J-Type Track Mini-I Connector, Silver	
35731	TRKJ/IC/1C/WH	Single Circuit J-Type Track I Connector, White	
35732	TRKJ/IC/1C/BL	Single Circuit J-Type Track I Connector, Black	
35733	TRKJ/IC/1C/SV	Single Circuit J-Type Track I Connector, Silver	
35755	TRKJ/IFC/1C/WH	Single Circuit J-Type Track Flexible I Connector, White	
35756	TRKJ/IFC/1C/BL	Single Circuit J-Type Track Flexible I Connector, Black	
35757	TRKJ/IFC/1C/SV	Single Circuit J-Type Track Flexible I Connector, Silver	
35734	TRKJ/LC/1C/WH	Single Circuit J-Type Track L Connector, White	
35735	TRKJ/LC/1C/BL	Single Circuit J-Type Track L Connector, Black	
35736	TRKJ/LC/1C/SV	Single Circuit J-Type Track L Connector, Silver	
35737	TRKJ/TC/1C/WH	Single Circuit J-Type Track T Connector, White	
35738	TRKJ/TC/1C/BL	Single Circuit J-Type Track T Connector, Black	
35739	TRKJ/TC/1C/SV	Single Circuit J-Type Track T Connector, Silver	
35740	TRKJ/TCR/1C/WH	Single Circuit J-Type Track Reverse T Connector, White	
35741	TRKJ/TCR/1C/BL	Single Circuit J-Type Track Reverse T Connector, Black	
35742	TRKJ/TCR/1C/SV	Single Circuit J-Type Track Reverse T Connector, Silver	
35743	TRKJ/XC/1C/WH	Single Circuit J-Type Track X Connector, White	
35744	TRKJ/XC/1C/BL	Single Circuit J-Type Track X Connector, Black	
35745	TRKJ/XC/1C/SV	Single Circuit J-Type Track X Connector, Silver	
35746	TRKJ/FCPY/1C/WH	Single Circuit J-Type Floating Canopy Feed, White	
35747	TRKJ/FCPY/1C/BL	Single Circuit J-Type Floating Canopy Feed, Black	
35748	TRKJ/FCPY/1C/SV	Single Circuit J-Type Floating Canopy Feed, Silver	
35749	TRKJ/SCF/1C/WH	Single Circuit J-Type Surface Conduit Feed, White	
35750	TRKJ/SCF/1C/BL	Single Circuit J-Type Surface Conduit Feed, Black	
35751	TRKJ/SCF/1C/SV	Single Circuit J-Type Surface Conduit Feed, Silver	
35761	TRKJ/ENDF/1C/WH	Single Circuit J-Type End Feed, White	
35762	TRKJ/ENDF/1C/BL	Single Circuit J-Type End Feed, Black	
35763	TRKJ/ENDF/1C/SV	Single Circuit J-Type End Feed, Silver	
35846	TRKJ/ENDFCOV/1C/WH	Single Circuit J-Type End Feed w/Cover, White	
35847	TRKJ/ENDFCOV/1C/BL	Single Circuit J-Type End Feed w/Cover, Black	
35848	TRKJ/ENDFCOV/1C/SV	Single Circuit J-Type End Feed w/Cover, Silver	
35852	TRKJ/TBENDF/1C/WH	Single Circuit J-Type T-Bar End Feed, White	
35853	TRKJ/TBENDF/1C/BL	Single Circuit J-Type T-Bar End Feed, Black	
35854	TRKJ/TBENDF/1C/SV	Single Circuit J-Type T-Bar End Feed, Silver	



SINGLE CIRCUIT J-TYPE TRACK SYSTEM

ORDERING GUIDE

Product	Model	Description	Picture
35831	TRK/COVPLATE/WH	Single Circuit J-Type Cover Plate, White For use with L, T & X Connectors.	
35832	TRK/COVPLATE/BL	Single Circuit J-Type Cover Plate, Black For use with L, T & X Connectors.	
35833	TRK/COVPLATE/SV	Single Circuit J-Type Cover Plate, Silver For use with L, T & X Connectors.	
35758	TRKJ/END/1C/WH	Single Circuit J-Type End Cap, White	
35759	TRKJ/END/1C/BL	Single Circuit J-Type End Cap, Black	
35760	TRKJ/END/1C/SV	Single Circuit J-Type End Cap, Silver	
35864	TRK/TBMOUNTCLIP	T-Bar Mounting Clip	
35858	TRK/SWIRCOV/WH	Wireway Cover for Stem Mount, White	
35859	TRK/SWIRCOV/BL	Wireway Cover for Stem Mount, Black	
35860	TRK/SWIRCOV/SV	Wireway Cover for Stem Mount, Silver	
35861	TRK/STCPY/WH	Stem Mount Canopy Kit, White	
35862	TRK/STCPY/BL	Stem Mount Canopy Kit, Black	
35863	TRK/STCPY/SV	Stem Mount Canopy Kit, Silver	
35865	TRK/STEMSLOPECPY/WH	Sloped Ceiling Stem Mount Canopy Kit, White	
35866	TRK/STEMSLOPECPY/BL	Sloped Ceiling Stem Mount Canopy Kit, Black	
35867	TRK/STEMSLOPECPY/SV	Sloped Ceiling Stem Mount Canopy Kit, Silver	
35868	STEM1-4/COUPLING/WH	1/4" IPS Stem Coupling, White	
35869	STEM1-4/COUPLING/BL	1/4" IPS Stem Coupling, Black	
35870	STEM1-4/COUPLING/SV	1/4" IPS Stem Coupling, Silver	
35943	STEM1-4/12/WH	12" Long -- 1/4" IPS Stem, White	
35944	STEM1-4/12/BL	12" Long -- 1/4" IPS Stem, Black	
35945	STEM1-4/12/SV	12" Long -- 1/4" IPS Stem, Silver	
35946	STEM1-4/24/WH	24" Long -- 1/4" IPS Stem, White	
35947	STEM1-4/24/BL	24" Long -- 1/4" IPS Stem, Black	
35948	STEM1-4/24/SV	24" Long -- 1/4" IPS Stem, Silver	
35949	STEM1-4/36/WH	36" Long -- 1/4" IPS Stem, White	
35950	STEM1-4/36/BL	36" Long -- 1/4" IPS Stem, Black	
35951	STEM1-4/36/SV	36" Long -- 1/4" IPS Stem, Silver	
35952	STEM1-4/48/WH	48" Long -- 1/4" IPS Stem, White	
35953	STEM1-4/48/BL	48" Long -- 1/4" IPS Stem, Black	
35954	STEM1-4/48/SV	48" Long -- 1/4" IPS Stem, Silver	

Note: All rights reserved. All sizes and specifications are subject to change at any time without notice.