

Project Name:	Type:
Part Number:	Date:

ORBIT TRACK HEAD S

SPECIFICATION FEATURES

- **Mechanical** - Compact fixture body made from die cast aluminum and polycarbonate lens design provide high quality light to compliment any space. Polycarbonate fixture lens holder design allows accessories to easily hold or snap in place. Fixture bodies and matching accessories are available in matte black, matte white and silver.
- **Electrical** - Field select from 2 lumen outputs using SelectDrive technology. Universal 120V only, 50/60 Hz drivers available. 120V drivers are dimmable to 5% using TRIAC or ELV dimmers.
- **Optical** - Fixture rotates 350° and tilts up to 120°. 15° Spot, 25° Narrow and 35° Flood beam angles available. Minimum 90 CRI with 2-step SDCM COB binning. Available in 2700K, 3000K, 3500K or 4000K CCT
- **Thermal** - Die cast heat sink maximizes passive thermal management and achieves a L70 rated lifetime of 50,000 hours. Ambient temperature rated from -22°F to 95°F (-30°C to 35°C).
- **Compliance and Warranty** - ETL Listed for dry locations. Complies with FCC 47CFR Part 15B consumer limits for EMI/RFI emissions. 5 year parts warranty for complete fixture.



030221

ASSOCIATED PRODUCTS
[TRACK SYSTEM](#)



BENEFITS

- Field selectable lumen output with SelectDrive technology.
- Compact cylindrical form factor compliments existing architecture.
- Matte black, white and silver finishes match existing track systems.
- H, J, and L track adapters with matching canopy mount available.
- Field interchangeable optics and accessories.

APPLICATIONS

- Retail
- Residential
- Hospitality
- Commercial
- Libraries and museums

LINE DRAWINGS

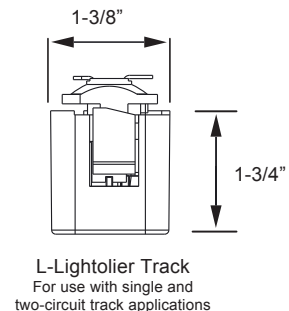
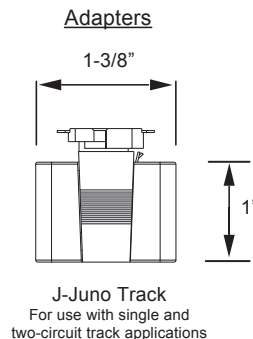
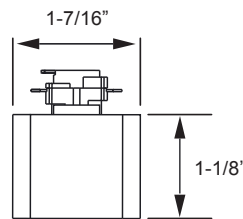
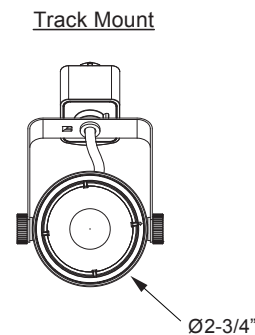
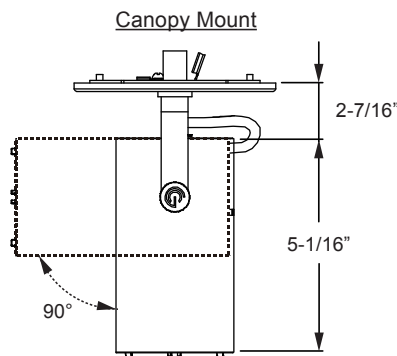



ORBIT TRACK HEAD S

ORDERING EXAMPLE

















A complete fixture consists of Output, Adapter, CCT, Beam and Finish Selected

ORB/S/930/NR/DIM120V/H/BL

ORDERING INFORMATION

Series	Lumen	CRI	CCT	Beam Angle	DRIVER	Adapter	Finish
<input checked="" type="checkbox"/> ORB ORBIT	<input checked="" type="checkbox"/> S Small 700 / 1,000 lumens	<input checked="" type="checkbox"/> 9 CRI 90+	<input type="checkbox"/> 27 2700K	<input type="checkbox"/> FL Flood 35°	<input checked="" type="checkbox"/> DIM120V 120V, 50/60 Hz, Forward and Reverse Phase Line Voltage Dimming to 5%	<input type="checkbox"/> H Halo	<input type="checkbox"/> WH White
			<input type="checkbox"/> 30 3000K	<input type="checkbox"/> NR Narrow 25°		<input type="checkbox"/> J Juno	<input type="checkbox"/> BL Black
			<input type="checkbox"/> 35 3500K	<input type="checkbox"/> SP Spot 15°		<input type="checkbox"/> L Lightolier	<input type="checkbox"/> SV Silver
			<input type="checkbox"/> 40 4000K			<input type="checkbox"/> CM Canopy Mount	

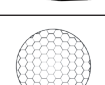
ACCESSORIES ORDERING INFORMATION

Product	Model	Description	Pictures	Product	Model	Description	Pictures
35365	ORB/ACC/S/SN/WH	Small Snoot White		35386	ORB/LENS/S/BLU	Small Lens Blue	
35366	ORB/ACC/S/SN/BL	Small Snoot Black		35387	ORB/LENS/S/RD	Small Lens Red	
35367	ORB/ACC/S/SN/SV	Small Snoot Silver		35388	ORB/LENS/S/YL	Small Lens Yellow	
35368	ORB/ACC/S/WW/WH	Small Wall Wash White		35389	ORB/LENS/S/LS	Small Lens Linear Spread	
35369	ORB/ACC/S/WW/BL	Small Wall Wash Black		35390	ORB/LENS/S/SOL	Small Lens Solite	
35370	ORB/ACC/S/WW/SV	Small Wall Wash Silver		35353	ORB/OPTIC/S/FL	Small Replacement Optic Flood 35°	
35371	ORB/ACC/S/BD/BL	Small Barn Doors Black		35354	ORB/OPTIC/S/NR	Small Replacement Optic Narrow 25°	
35362	ORB/ACC/S/HC ¹	Small Honeycomb Louver		35355	ORB/OPTIC/S/SP	Small Replacement Optic Spot 15°	

¹ HC only comes in black finish.

TECHNICAL INFORMATION

Dimming	Input Voltage	Input Frequency	Input Current	Input Power	THD Power	Power Factor
120V, Forward and reverse phase dimming to 5%	120V	50 / 60Hz	150 / 200mA	7 / 10W	<20%	>0.9



ORBIT TRACK HEAD S

PHOTOMETRY

Notes and Definitions:

- D=Distance to floor or wall
- FC=Footcandles on floor or wall at center beam location
- L=Effective Visual Beam length in feet
- W=Effective Visual Beam width in feet
- X=In vertical aiming applications, (X) is the distance down to the center beam location

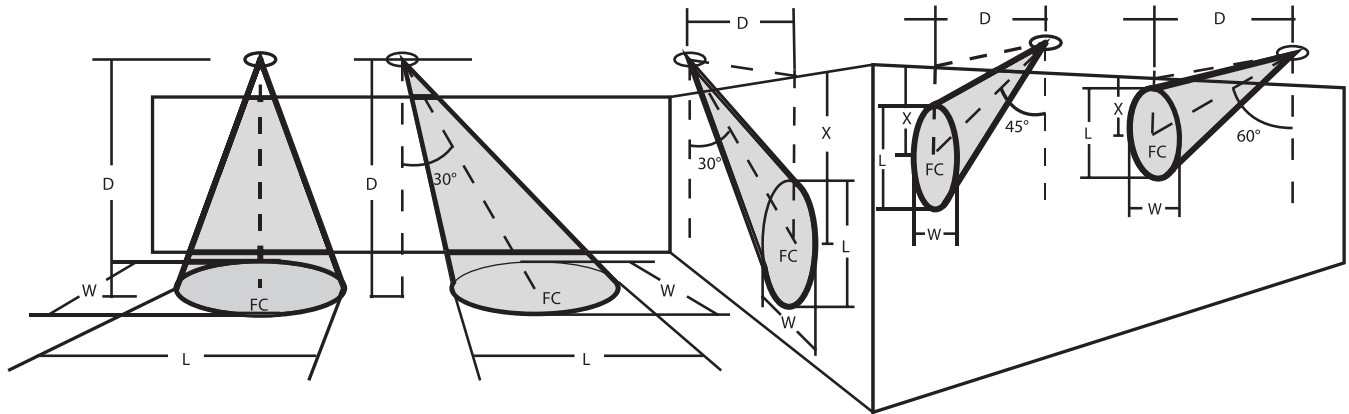

 0° Horizontal Aiming Angle				 30° Horizontal Aiming Angle				 30° Vertical Aiming Angle				 45° Vertical Aiming Angle				 60° Vertical Aiming Angle			
ORB/S/930/SP/DIM120V/xx/yy High Output (6.6W) Lumens: 645 Beam Angle: SPOT 17° CCT: 3000K CBCP: 5,079																			
D	FC	L	W	D	FC	L	W	D	FC	L	W	D	FC	L	W	D	FC	L	W
6	141.1	1.8	1.8	6	105.8	2.4	2.1	3	141.1	3.8	1.8	3	282.2	1.8	1.0	3	105.8	2.4	2.1
8	79.4	2.4	2.4	8	59.5	3.2	2.8	4	79.4	5.1	2.4	4	158.7	2.4	1.4	4	59.5	3.2	2.8
10	50.8	3.0	3.0	10	38.1	4.0	3.5	5	50.8	6.4	3.0	5	101.6	3.1	1.7	5	38.1	4.0	3.5
12	35.3	3.6	3.6	12	26.5	4.8	4.1	6	35.3	7.7	3.6	6	70.5	3.7	2.1	6	26.5	4.8	4.1
14	25.9	4.2	4.2	14	19.4	5.6	4.8	7	25.9	9.0	4.2	7	51.8	4.3	2.4	7	19.4	5.6	4.8
ORB/S/930/NR/DIM120V/xx/yy Low Output (6.6W) Lumens: 643 Beam Angle: NARROW 27° CCT: 3000K CBCP: 2,482																			
D	FC	L	W	D	FC	L	W	D	FC	L	W	D	FC	L	W	D	FC	L	W
6	68.9	2.9	2.9	6	51.7	3.9	3.3	3	68.9	7.0	2.9	3	137.9	3.1	1.7	3	51.7	3.9	3.3
8	38.8	3.9	3.9	8	29.1	5.2	4.5	4	38.8	9.3	3.9	4	77.6	4.1	2.2	4	29.1	5.2	4.5
10	24.8	4.8	4.8	10	18.6	6.6	5.6	5	24.8	11.7	4.8	5	49.6	5.1	2.8	5	18.6	6.6	5.6
12	17.2	5.8	5.8	12	12.9	7.9	6.7	6	17.2	14.0	5.8	6	34.5	6.1	3.3	6	12.9	7.9	6.7
14	12.7	6.7	6.7	14	9.5	9.2	7.8	7	12.7	16.3	6.7	7	25.3	7.2	3.9	7	9.5	9.2	7.8
ORB/S/930/FL/DIM120V/xx/yy Low Output (6.6W) Lumens: 650 Beam Angle: FLOOD 35° CCT: 3000K CBCP: 1,719																			
D	FC	L	W	D	FC	L	W	D	FC	L	W	D	FC	L	W	D	FC	L	W
6	47.8	3.8	3.8	6	35.8	5.2	4.4	3	47.7	10.8	3.8	3	95.5	4.2	2.2	3	35.8	5.2	4.4
8	26.9	5.1	5.1	8	20.1	7.0	5.8	4	26.9	14.5	5.1	4	53.7	5.6	2.9	4	20.1	7.0	5.8
10	17.2	6.3	6.3	10	12.9	8.7	7.3	5	17.2	18.1	6.3	5	34.4	7.0	3.7	5	12.9	8.7	7.3
12	11.9	7.6	7.6	12	9.0	10.5	8.8	6	11.9	21.7	7.6	6	23.9	8.4	4.4	6	9.0	10.5	8.8
14	8.8	8.9	8.9	14	6.6	12.2	10.2	7	8.8	25.3	8.9	7	17.5	9.8	5.1	7	6.6	12.2	10.2
ORB/S/930/SP/DIM120V/xx/yy Low Output (10W) Lumens: 981.65 Beam Angle: SPOT 17° CCT: 3000K CBCP: 7,923																			
D	FC	L	W	D	FC	L	W	D	FC	L	W	D	FC	L	W	D	FC	L	W
6	220.1	1.8	1.8	6	165.1	2.4	2.1	3	220.1	3.8	1.8	3	440.1	1.8	1.0	3	165.1	2.41	2.07
8	123.8	2.4	2.4	8	92.8	3.2	2.8	4	123.8	5.1	2.4	4	247.6	2.4	1.4	4	92.8	3.21	2.76
10	79.2	3.0	3.0	10	59.4	4.0	3.5	5	79.2	6.4	3.0	5	158.5	3.1	1.7	5	59.4	4.02	3.45
12	55.0	3.6	3.6	12	41.3	4.8	4.1	6	55.0	7.7	3.6	6	110.0	3.7	2.1	6	41.3	4.82	4.14
14	40.4	4.2	4.2	14	30.3	5.6	4.8	7	40.4	9.0	4.2	7	80.8	4.3	2.4	7	30.3	5.62	4.83



ORBIT TRACK HEAD S

PHOTOMETRY

ORB/S/930/NR/DIM120V/xx/yy				High Output (10W)				Lumens: 959.35				Beam Angle: NARROW 27°				CCT: 3000K				CBCP: 3,444			
D	FC	L	W	D	FC	L	W	D	FC	L	W	D	FC	L	W	D	FC	L	W	D	FC	L	W
6	95.7	2.9	2.9	6	71.8	3.9	3.3	3	95.7	7.0	2.9	3	191.3	3.1	1.7	3	71.7	3.9	3.3				
8	53.8	3.9	3.9	8	40.4	5.2	4.5	4	53.8	9.3	3.9	4	107.6	4.1	2.2	4	40.4	5.2	4.5				
10	34.4	4.8	4.8	10	25.8	6.6	5.6	5	34.4	11.7	4.8	5	68.9	5.1	2.8	5	25.8	6.6	5.6				
12	23.9	5.8	5.8	12	17.9	7.9	6.7	6	23.9	14.0	5.8	6	47.8	6.1	3.3	6	17.9	7.9	6.7				
14	17.6	6.7	6.7	14	13.2	9.2	7.8	7	17.6	16.3	6.7	7	35.1	7.2	3.9	7	13.2	9.2	7.8				

ORB/S/930/FL/DIM120V/xx/yy				High Output (10W)				Lumens: 963.71				Beam Angle: FLOOD 35°				CCT: 3000K				CBCP: 2,522			
D	FC	L	W	D	FC	L	W	D	FC	L	W	D	FC	L	W	D	FC	L	W	D	FC	L	W
6	70.1	3.8	3.8	6	52.5	5.2	4.4	3	70.1	10.9	3.8	3	140.1	4.2	2.2	3	52.6	5.2	4.4				
8	39.4	5.1	5.1	8	29.6	7.0	5.9	4	39.4	14.5	5.1	4	78.8	5.6	2.9	4	29.6	7.0	5.8				
10	25.2	6.3	6.3	10	18.9	8.7	7.3	5	25.2	18.1	6.3	5	50.4	7.0	3.7	5	18.9	8.7	7.3				
12	17.5	7.6	7.6	12	13.1	10.5	8.8	6	17.5	21.7	7.6	6	35.0	8.4	4.4	6	13.1	10.5	8.8				
14	12.9	8.9	8.9	14	9.7	12.2	10.2	7	12.9	25.3	8.9	7	25.7	9.8	5.1	7	9.7	12.2	10.2				

ORB/S/930/SP/DIM120V/xx/yy Low Output (7W)

Lumens: 645lm
CBCP: 5,079cd
Power: 6.6W
Efficacy: 97.7lm/W
CRI: 90
Spacing Criteria: 0.3
Beam Angle: 17°

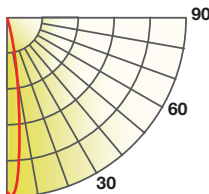

SPOT

Degree	Candela
0	5,079
15	696
25	139
35	29
45	14

ORB/S/930/SP/DIM120V/xx/yy High Output (10W)

Lumens: 982lm
CBCP: 7,923cd
Power: 10W
Efficacy: 100lm/W
CRI: 90
Spacing Criteria: 0.28
Beam Angle: 17°

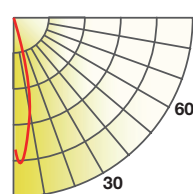

SPOT

Degree	Candela
0	7,923
15	1,056
25	188
35	36
45	18

ORB/S/930/NR/DIM120V/xx/yy Low Output (7W)

Lumens: 643lm
CBCP: 2,482cd
Power: 6.6W
Efficacy: 97.3lm/W
CRI: 90
Spacing Criteria: 0.42
Beam Angle: 27.1°

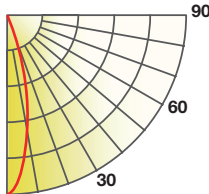

NARROW

Degree	Candela
0	2,482
15	922
25	199
35	68
45	30

ORB/S/930/NR/DIM120V/xx/yy High Output (10W)

Lumens: 959lm
CBCP: 3,444cd
Power: 10W
Efficacy: 98lm/W
CRI: 90
Spacing Criteria: 0.44
Beam Angle: 27.1°

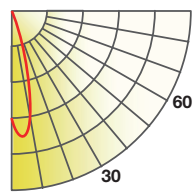

NARROW

Degree	Candela
0	3,444
15	1,471
25	316
35	108
45	32

ORB/S/930/FL/DIM120V/xx/yy Low Output (7W)

Lumens: 650lm
CBCP: 1,719cd
Power: 6.6W
Efficacy: 98.48lm/W
CRI: 90
Spacing Criteria: 0.54
Beam Angle: 35.1°

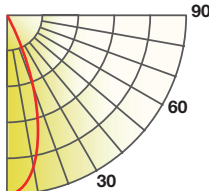

FLOOD

Degree	Candela
0	1,719
15	1,037
25	272
35	68
45	27

ORB/S/930/FL/DIM120V/xx/yy High Output (10W)

Lumens: 964lm
CBCP: 2,522cd
Power: 10W
Efficacy: 99lm/W
CRI: 90
Spacing Criteria: 0.53
Beam Angle: 35.1°

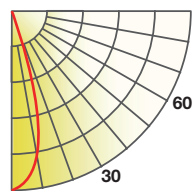

FLOOD

Degree	Candela
0	2,522
15	1,576
25	416
35	96
45	37

PERFORMANCE

Series	Beam Angle	2700K			3000K			3500K			4000K		
		Output (lm)	Efficacy (lm/W)	CBCP (cd)	Output (lm)	Efficacy (lm/W)	CBCP (cd)	Output (lm)	Efficacy (lm/W)	CBCP (cd)	Output (lm)	Efficacy (lm/W)	CBCP (cd)
ORBIT S Low Output	Spot 15°	658	94	4,935	700	100	5,250	728	104	5,460	735	105	5,512
	Narrow 25°	658	94	2,303	700	100	2,450	728	104	2,548	735	105	2,572
	Flood 35°	658	94	1,711	700	100	1,820	728	104	1,893	735	105	1,911
ORBIT S High Output	Spot 15°	940	94	7,050	1000	100	7,500	1040	104	7,800	1050	105	7,875
	Narrow 25°	940	94	3,290	1000	100	3,500	1040	104	3,640	1050	105	3,675
	Flood 35°	940	94	2,444	1000	100	2,600	1040	104	2,704	1050	105	2,730

Note: All rights reserved. All sizes and specifications are subject to change at any time without notice.