

Project Name:	Type:
Part Number:	Date:

# ORBIT TRACK HEAD M

## SPECIFICATION FEATURES

- **Mechanical** - Compact fixture body made from die cast aluminum and polycarbonate lens design provide high quality light to compliment any space. Polycarbonate fixture lens holder design allows accessories to easily hold or snap in place. Fixture bodies and matching accessories are available in matte black, matte white and silver.
- **Electrical** - Field select from 2 lumen outputs using SelectDrive technology. Universal 120V only, 50/60 Hz drivers available. 120V drivers are dimmable to 5% using TRIAC or ELV dimmers.
- **Optical** - Fixture rotates 350° and tilts up to 120°. 15° Spot, 25° Narrow and 35° Flood beam angles available. Minimum 90 CRI with 2-step SDCM COB binning. Available in 2700K, 3000K, 3500K or 4000K CCT
- **Thermal** - Die cast heat sink maximizes passive thermal management and achieves a L70 rated lifetime of 50,000 hours. Ambient temperature rated from -22°F to 95°F (-30°C to 35°C).
- **Compliance and Warranty** - ETL Listed for dry locations. Complies with FCC 47CFR Part 15B consumer limits for EMI/RFI emissions. 5 year parts warranty for complete fixture. ENERGY STAR® listed. JA8 Certified to meet CA Title 24 requirements.



060223



ASSOCIATED PRODUCTS  
[TRACK SYSTEM](#)

## BENEFITS

- Field selectable lumen output with SelectDrive technology.
- Compact cylindrical form factor compliments existing architecture.
- Matte black, white and silver finishes match existing track systems.
- H, J, and L track adapters with matching canopy mount available.
- Field interchangeable optics and accessories.

## APPLICATIONS

- Retail
- Residential
- Hospitality
- Commercial
- Libraries and museums

## LINE DRAWINGS

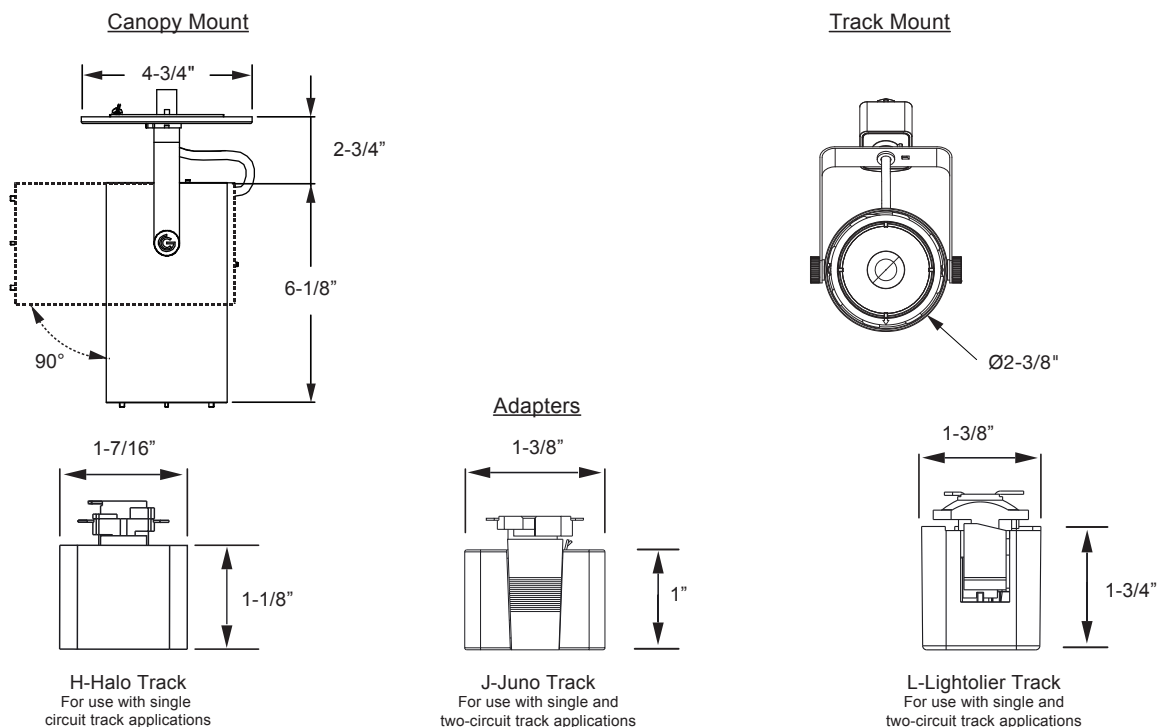



# ORBIT TRACK HEAD M

## ORDERING EXAMPLE



















A complete fixture consists of Output, Adapter, CCT, Beam and Finish Selected

ORB/M/930/NR/DIM120V/H/BL

## ORDERING INFORMATION

Series	Lumen	CRI	CCT	Beam Angle	DRIVER	Adapter	Finish
<input checked="" type="checkbox"/> <b>ORB</b> ORBIT	<input checked="" type="checkbox"/> <b>M</b> Medium 1,500 / 2,000 lumens	<input checked="" type="checkbox"/> <b>9</b> CRI 90+	<input type="checkbox"/> <b>27</b> 2700K	<input type="checkbox"/> <b>FL</b> Flood 35°	<input checked="" type="checkbox"/> <b>DIM120V</b> 120V, 50/60 Hz, Forward and Reverse Phase Line Voltage Dimming to 5%	<input type="checkbox"/> <b>H</b> Halo	<input type="checkbox"/> <b>WH</b> White
			<input type="checkbox"/> <b>30</b> 3000K	<input type="checkbox"/> <b>NR</b> Narrow 25°		<input type="checkbox"/> <b>J</b> Juno	<input type="checkbox"/> <b>BL</b> Black
			<input type="checkbox"/> <b>35</b> 3500K	<input type="checkbox"/> <b>SP</b> Spot 15°		<input type="checkbox"/> <b>L</b> Lightolier	<input type="checkbox"/> <b>SV</b> Silver
			<input type="checkbox"/> <b>40</b> 4000K			<input type="checkbox"/> <b>CM</b> Canopy Mount	

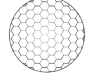
## ACCESSORIES ORDERING INFORMATION

Product	Model	Description	Pictures	Product	Model	Description	Pictures
35372	ORB/ACC/M/SN/WH	Medium Snoot White		35394	ORB/LENS/M/LS	Medium Lens Linear Spread	
35373	ORB/ACC/M/SN/BL	Medium Snoot Black		35395	ORB/LENS/M/SOL	Medium Lens Solite	
35374	ORB/ACC/M/SN/SV	Medium Snoot Silver		37053	ORB/LENS/M/SQ3636	Medium - Square lens 36°x36°	 
35375	ORB/ACC/M/WW/WH	Medium Wall Wash White		36915	ORB/LENS/M/CCT22	Medium - CCT Shift Lens 2700K to 2200K	 
35376	ORB/ACC/M/WW/BL	Medium Wall Wash Black		36916	ORB/LENS/M/CCT24	Medium - CCT Shift Lens 2700K to 2400K	 
35377	ORB/ACC/M/WW/SV	Medium Wall Wash Silver		35356	ORB/OPTIC/M/FL	Medium Replacement Optic Flood 35°	
35378	ORB/ACC/M/BD/BL	Medium Barn Doors Black		35357	ORB/OPTIC/M/NR	Medium Replacement Optic Narrow 25°	
35363	ORB/ACC/M/HC <sup>1</sup>	Medium Honeycomb Louver		35358	ORB/OPTIC/M/SP	Medium Replacement Optic Spot 15°	

<sup>1</sup> HC only comes in black finish.

## TECHNICAL INFORMATION

Dimming	Input Voltage	Input Frequency	Input Current	Input Power	THD Power	Power Factor
120V, Forward and reverse phase dimming to 5%	120V	50 / 60Hz	150 / 200mA	15 / 20W	<20%	>0.9



# ORBIT TRACK HEAD M

## PHOTOMETRY

Notes and Definitions:

- D=Distance to floor or wall
- FC=Footcandles on floor or wall at center beam location
- L=Effective Visual Beam length in feet
- W=Effective Visual Beam width in feet
- X=In vertical aiming applications, (X) is the distance down to the center beam location

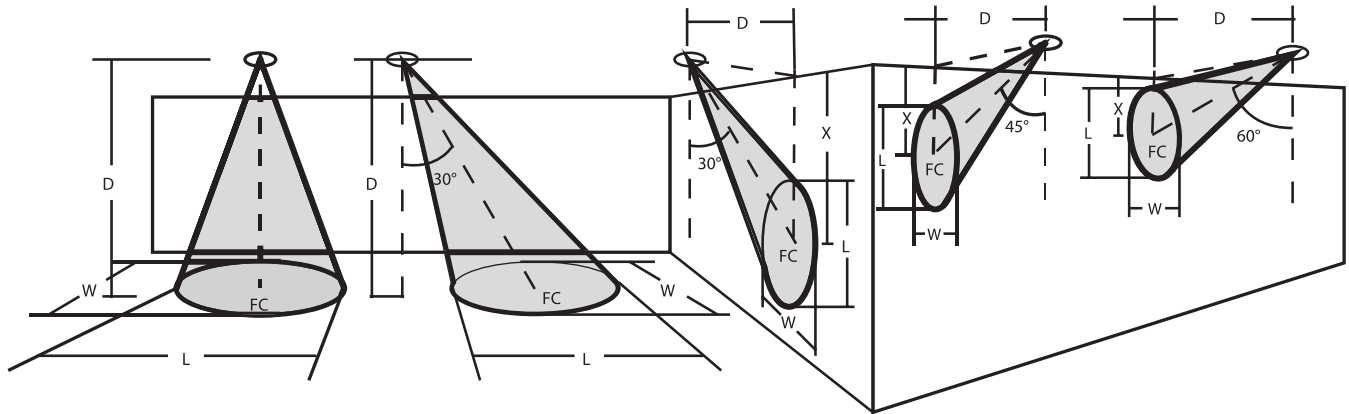

0° Horizontal Aiming Angle				30° Horizontal Aiming Angle				30° Vertical Aiming Angle				45° Vertical Aiming Angle				60° Vertical Aiming Angle			
ORB/M/930/SP/DIM120V/xx/yy Low Output (14.8W)				Lumens: 1,436				Beam Angle: SPOT 15.5°				CCT: 3000K				CBCP: 1,387			
D	FC	L	W	D	FC	L	W	D	FC	L	W	D	FC	L	W	D	FC	L	W
6	385.3	1.6	1.6	6	289.0	2.2	1.9	3	385.3	3.5	1.6	3	770.5	1.7	0.9	3	288.9	2.2	1.9
8	216.7	2.2	2.2	8	162.5	2.9	2.5	4	216.7	4.6	2.2	4	433.4	2.2	1.3	4	162.5	2.9	2.5
10	138.7	2.7	2.7	10	104.0	3.7	3.1	5	138.7	5.8	2.7	5	277.4	2.8	1.6	5	104.0	3.7	3.1
12	96.3	3.3	3.3	12	72.2	4.4	3.8	6	96.3	6.9	3.3	6	192.6	3.3	1.9	6	72.2	4.4	3.8
14	70.8	3.8	3.8	14	53.1	5.1	4.4	7	70.8	8.1	3.8	7	141.5	3.9	2.2	7	53.1	5.1	4.4
ORB/M/930/NR/DIM120V/xx/yy Low Output (14.8W)				Lumens: 1,482				Beam Angle: NARROW 22.3°				CCT: 3000K				CBCP: 7,926			
D	FC	L	W	D	FC	L	W	D	FC	L	W	D	FC	L	W	D	FC	L	W
6	220.2	2.4	2.4	6	165.1	3.2	2.7	3	220.2	5.4	2.4	3	440.3	2.5	1.4	3	165.1	3.2	2.7
8	123.8	3.2	3.2	8	92.9	4.3	3.6	4	123.8	7.1	3.2	4	247.7	3.3	1.8	4	92.9	4.3	3.6
10	79.3	3.9	3.9	10	59.4	5.3	4.6	5	79.3	8.9	3.9	5	158.5	4.1	2.3	5	59.4	5.3	4.6
12	55.0	4.7	4.7	12	41.3	6.4	5.5	6	55.0	10.7	4.7	6	110.1	4.9	2.7	6	41.3	6.4	5.5
14	40.4	5.5	5.5	14	30.3	7.5	6.4	7	40.4	12.5	5.5	7	80.9	5.7	3.2	7	30.3	7.5	6.4
ORB/M/930/FL/DIM120V/xx/yy Low Output (14.8W)				Lumens: 1,480				Beam Angle: FLOOD 32.9°				CCT: 3000K				CBCP: 4,799			
D	FC	L	W	D	FC	L	W	D	FC	L	W	D	FC	L	W	D	FC	L	W
6	133.3	3.5	3.5	6	100.0	4.9	4.1	3	133.3	9.6	3.5	3	266.6	3.9	2.0	3	100.0	4.9	4.1
8	75.0	4.7	4.7	8	56.2	6.5	5.5	4	75.0	12.8	4.7	4	150.0	5.2	2.7	4	56.2	6.5	5.5
10	48.0	5.9	5.9	10	36.0	8.1	6.8	5	48.0	16.0	5.9	5	96.0	6.5	3.4	5	36.0	8.1	6.8
12	33.3	7.1	7.1	12	25.0	9.7	8.2	6	33.3	19.2	7.1	6	66.6	7.8	4.1	6	25.0	9.7	8.2
14	24.5	8.3	8.3	14	18.4	11.4	9.5	7	24.5	22.4	8.3	7	49.0	9.1	4.8	7	18.4	11.4	9.5
ORB/M/930/SP/DIM120V/xx/yy High Output (21W)				Lumens: 1,904				Beam Angle: SPOT 13.8°				CCT: 3000K				CBCP: 20,379			
D	FC	L	W	D	FC	L	W	D	FC	L	W	D	FC	L	W	D	FC	L	W
6	566.1	1.5	1.5	6	424.6	1.9	1.7	3	566.1	3.0	1.5	3	1132.1	1.5	0.8	3	424.5	1.9	1.7
8	318.4	1.9	1.9	8	238.8	2.6	2.2	4	318.4	4.1	1.9	4	636.8	2.0	1.1	4	238.8	2.6	2.2
10	203.8	2.4	2.4	10	152.8	3.2	2.8	5	203.8	5.1	2.4	5	407.6	2.5	1.4	5	152.8	3.2	2.8
12	141.5	2.9	2.9	12	106.1	3.9	3.4	6	141.5	6.1	2.9	6	283.0	2.9	1.7	6	106.1	3.9	3.4
14	104.0	3.4	3.4	14	78.0	4.5	3.9	7	104.0	7.1	3.4	7	207.9	3.4	2.0	7	78.0	4.5	3.9



# ORBIT TRACK HEAD M

## PHOTOMETRY

ORB/M/930/NR/DIM120V/xx/yy				High Output (21W)				Lumens: 1,925				Beam Angle: NARROW 22.3°				CCT: 3000K				CBCP: 10,371			
D	FC	L	W	D	FC	L	W	D	FC	L	W	D	FC	L	W	D	FC	L	W	D	FC	L	W
6	288.1	2.4	2.4	6	216.1	3.2	2.7	3	288.1	5.4	2.4	3	576.1	2.5	1.4	3	216.1	3.2	2.7				
8	162.0	3.2	3.2	8	121.5	4.3	3.6	4	162.0	7.1	3.2	4	324.1	3.3	1.8	4	121.5	4.3	3.6				
10	103.7	3.9	3.9	10	77.8	5.3	4.6	5	103.7	8.9	3.9	5	207.4	4.1	2.3	5	77.8	5.3	4.6				
12	72.0	4.7	4.7	12	54.0	6.4	5.5	6	72.0	10.7	4.7	6	144.0	4.9	2.7	6	54.0	6.4	5.5				
14	52.9	5.5	5.5	14	39.7	7.5	6.4	7	52.9	12.5	5.5	7	105.8	5.7	3.2	7	39.7	7.5	6.4				

ORB/M/930/FL/DIM120V/xx/yy				High Output (21W)				Lumens: 1,919				Beam Angle: FLOOD 32.8°				CCT: 3000K				CBCP: 5,958			
D	FC	L	W	D	FC	L	W	D	FC	L	W	D	FC	L	W	D	FC	L	W	D	FC	L	W
6	165.5	3.5	3.5	6	124.1	4.8	4.1	3	165.5	9.5	3.5	3	331.0	3.9	2.0	3	124.1	4.8	4.1				
8	93.1	4.7	4.7	8	69.8	6.5	5.4	4	93.1	12.7	4.7	4	186.2	5.2	2.7	4	69.8	6.5	5.4				
10	59.6	5.9	5.9	10	44.7	8.1	6.8	5	59.6	15.9	5.9	5	119.2	6.4	3.4	5	44.7	8.1	6.8				
12	41.4	7.1	7.1	12	31.0	9.7	8.2	6	41.4	19.1	7.1	6	82.7	7.7	4.1	6	31.0	9.7	8.2				
14	30.4	8.2	8.2	14	22.8	11.3	9.5	7	30.4	22.3	8.2	7	60.8	9.0	4.8	7	22.8	11.3	9.5				

ORB/M/930/SP/DIM120V/xx/yy Low Output (14.8W)

Lumens: 1,436lm  
CBCP: 13,870cd  
Power: 14.8W  
Efficacy: 97lm/W  
CRI: 90  
Spacing Criteria: 0.26  
Beam Angle: 15.5°

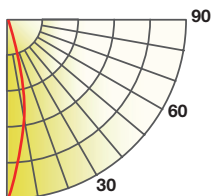

SPOT

Degree	Candela
0	13,870
15	1,339
25	258
35	65
45	33

ORB/M/930/SP/DIM120V/xx/yy High Output (21W)

Lumens: 1,904lm  
CBCP: 20,379cd  
Power: 21W  
Efficacy: 90lm/W  
CRI: 90  
Spacing Criteria: 0.24  
Beam Angle: 13.8°

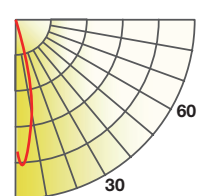

SPOT

Degree	Candela
0	20,379
15	1,684
25	343
35	86
45	44

ORB/M/930/NR/DIM120V/xx/yy Low Output (14.8W)

Lumens: 1,482lm  
CBCP: 7,926cd  
Power: 14.8W  
Efficacy: 100lm/W  
CRI: 90  
Spacing Criteria: 0.38  
Beam Angle: 22.3°

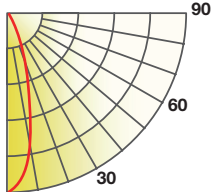

NARROW

Degree	Candela
0	7,926
15	2,345
25	279
35	63
45	29

ORB/M/930/NR/DIM120V/xx/yy High Output (21W)

Lumens: 1,925lm  
CBCP: 10,371cd  
Power: 21W  
Efficacy: 92lm/W  
CRI: 90  
Spacing Criteria: 0.42  
Beam Angle: 22.3°

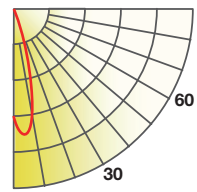

NARROW

Degree	Candela
0	10,371
15	3,043
25	364
35	81
45	37

ORB/M/930/FL/DIM120V/xx/yy Low Output (14.8W)

Lumens: 1,480lm  
CBCP: 4,799cd  
Power: 14.8W  
Efficacy: 100lm/W  
CRI: 90  
Spacing Criteria: 0.54  
Beam Angle: 32.9°

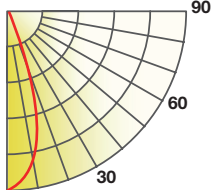

FLOOD

Degree	Candela
0	4,799
15	2,758
25	495
35	53
45	22

ORB/M/930/FL/DIM120V/xx/yy High Output (21W)

Lumens: 1,919lm  
CBCP: 6,314cd  
Power: 21W  
Efficacy: 92lm/W  
CRI: 90  
Spacing Criteria: 0.51  
Beam Angle: 32.8°

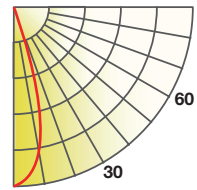

FLOOD

Degree	Candela
0	6,314
15	3,449
25	653
35	69
45	16

## PERFORMANCE

CCT		2700K			3000K			3500K			4000K		
Series	Beam Angle	Output (lm)	Efficacy (lm/W)	CBCP (cd)	Output (lm)	Efficacy (lm/W)	CBCP (cd)	Output (lm)	Efficacy (lm/W)	CBCP (cd)	Output (lm)	Efficacy (lm/W)	CBCP (cd)
ORBIT M Low Output	Spot 15°	1,350	90	14,715	1,425	95	14,962	1,485	99	15,592	1,500	100	15,750
	Narrow 25°	1,350	90	7,155	1,425	95	7,552	1,485	99	7,870	1,500	100	7,950
	Flood 35°	1,350	90	4,050	1,425	95	4,175	1,485	99	4,455	1,500	100	4,500
ORBIT M High Output	Spot 15°	1,800	90	18,900	1,900	95	19,950	1,980	99	20,790	2,000	100	21,000
	Narrow 25°	1,800	90	9,540	1,900	95	10,070	1,980	99	10,494	2,000	100	10,600
	Flood 35°	1,800	90	5,400	1,900	95	5,700	1,980	99	5,940	2,000	100	6,000

Note: All rights reserved. All sizes and specifications are subject to change at any time without notice.