

Project Name:	Type:
Part Number:	Date:

HID LOW / HIGH BAY LAMP

FEATURES

- Integral driver suitable for 120-277V
- Integral surge protector:
35W/65W: 4kV
90W/120W/135W: 6kV
- Integral thermal sensor reduces power to the lamp in the event ambient temperature exceeds specified limitations (except 35W)
- Replaces up to a 400W HID
- Suitable for damp locations, not suitable for use in totally enclosed fixtures*
- Lamp ambient temperature: -4°F to 140°F (-20°C to 60°C)
- Fixture operating temperature:
35W/65W/90W/120W: -4°F to 113°F (-20°C to 45°C)
135W: -4°F to 122°F (-20°C to 50°C)
- Rated lifetime (L70): 50,000hrs
- 5 years limited warranty*
- Supplied with safety support cable
- Lamp CCT falls within 5 SDCM for consistent CCT



040821



SPECIFICATIONS

Product	Model	Equiv. (HID)	Input Voltage	Wattage	Lumens	CCT	CRI	Efficacy (LPW)	Beam Angle	Power Factor	THD	Fixture Rating	DLC
35089	35HIDLB/840/BYP/E26/R	175W	120-277V	35	4,550	4000K	82	130	110°	0.9	<20%	Non-Enclosed	N.A.
35090	35HIDLB/850/BYP/E26/R	175W	120-277V	35	4,650	5000K	82	133	110°	0.9	<20%	Non-Enclosed	N.A.
35087	35HIDLB/840/BYP/EX39/R	175W	120-277V	35	4,550	4000K	82	130	110°	0.9	<20%	Non-Enclosed	√
35088	35HIDLB/850/BYP/EX39/R	175W	120-277V	35	4,650	5000K	82	133	110°	0.9	<20%	Non-Enclosed	√
35091	65HIDHB/840/BYP/EX39/R	250W	120-277V	65	8,970	4000K	82	138	110°	0.9	<20%	Non-Enclosed	√
35092	65HIDHB/850/BYP/EX39/R	250W	120-277V	65	9,100	5000K	82	140	110°	0.9	<20%	Non-Enclosed	√
35093	90HIDHB/840/BYP/EX39/R	400W	120-277V	90	12,420	4000K	82	138	110°	0.9	<20%	Non-Enclosed	√
35094	90HIDHB/850/BYP/EX39/R	400W	120-277V	90	12,600	5000K	82	140	110°	0.9	<20%	Non-Enclosed	√
35059	120HIDHB/840/BYP/EX39	400W	120-277V	120	17,760	4000K	82	148	110°	0.9	<20%	Non-Enclosed	√
35060	120HIDHB/850/BYP/EX39	400W	120-277V	120	18,000	5000K	82	150	110°	0.9	<20%	Non-Enclosed	√
34985	135HIDHB/840/BYP/EX39	400W	120-277V	135	20,000	4000K	82	148	120°	0.9	<20%	Non-Enclosed	√
34986	135HIDHB/850/BYP/EX39	400W	120-277V	135	20,000	5000K	82	148	120°	0.9	<20%	Non-Enclosed	√
35011	135HIDHBSSEN/840/BYP/EX39	400W	120-277V	135	20,000	4000K	82	148	120°	0.9	<20%	Non-Enclosed	√
35012	135HIDHBSSEN/850/BYP/EX39	400W	120-277V	135	20,000	5000K	82	148	120°	0.9	<20%	Non-Enclosed	√

* Please visit www.greencreative.com for Limited Warranty terms.



HID LOW / HIGH BAY LAMP

DIMENSION & WEIGHT

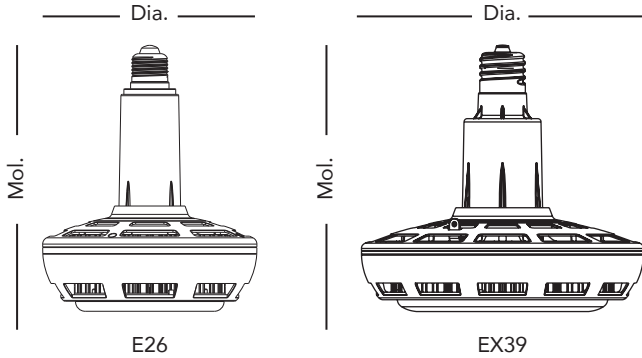

Model	Base	Mol.	Dia.	Weight
35HIDLB/xxx/BYP/E26/R	E26	7-11/16"	6-1/8"	1.7 lb
35HIDLB/xxx/BYP/EX39/R	EX39	7-11/16"	6-1/8"	1.7 lb
65HIDHB/xxx/BYP/EX39/R	EX39	8-1/4"	7-11/16"	2.67 lb
90HIDHB/xxx/BYP/EX39/R	EX39	9-1/4"	9-1/2"	3.57 lb
120HIDHB/xxx/BYP/EX39	EX39	9-1/4"	9-1/2"	3.59 lb
135HIDHB/xxx/BYP/EX39	EX39	10-7/8"	9-13/16"	3.64 lb
135HIDHBM/xxx/BYP/EX39	EX39	10-7/8"	9-13/16"	3.64 lb

Where xxx means 824-965 which indicates CRI and color temperature

*MINIMUM COMPARTMENT DIMENSIONS

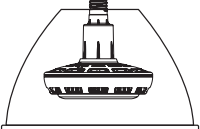
	Model	Diameter	Height	Maximum Lamps in Luminaire
35W HID 	35HIDLB/xxx/BYP/E26/R	10-1/2"	6-1/4"	1
	35HIDLB/xxx/BYP/EX39/R	10-1/2"	6-1/4"	1
65W / 90W / 120W / 135W HID 	65HIDHB/xxx/BYP/EX39/R	13-13/16"	8-1/4"	1
	90HIDHB/xxx/BYP/EX39/R	13-13/16"	8-1/4"	1
	120HIDHB/xxx/BYP/EX39	13-13/16"	8-1/4"	1
	135HIDHB/xxx/BYP/EX39	13-13/16"	8-1/4"	1
	135HIDHBM/xxx/BYP/EX39	13-13/16"	8-1/4"	1

*Installing lamp in a fixture that does not have the minimum compartment dimensions will void the warranty and could cause product failures.
Where xxx means 824-965 which indicates CRI and color temperature

TEMPERATURE

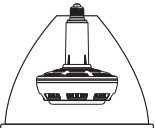
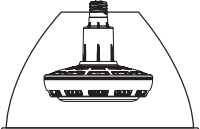
	Model	Fixture operating temperature	Lamp ambient temperature
35W HID 	35HIDLB/xxx/BYP/E26/R	-4°F to 113°F (-20°C to 45°C)	-4°F to 140°F (-20°C to 60°C)
	35HIDLB/xxx/BYP/EX39/R		
65W / 90W / 120W / 135W HID 	65HIDHB/xxx/BYP/EX39/R	-4°F to 122°F (-20°C to 50°C)	-4°F to 140°F (-20°C to 60°C)
	90HIDHB/xxx/BYP/EX39/R		
	120HIDHB/xxx/BYP/EX39		
	135HIDHB/xxx/BYP/EX39		
	135HIDHBM/xxx/BYP/EX39		





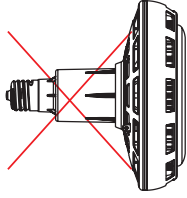
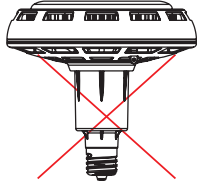
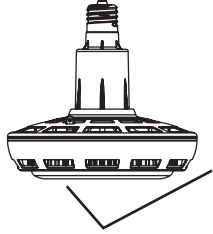

Where xxx means 824-965 which indicates CRI and color temperature

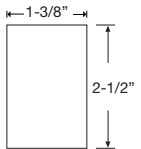

HID LOW / HIGH BAY LAMP

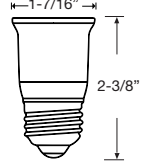
MOUNTING ORIENTATION	
Horizontal Installation	Vertical Installation
	 

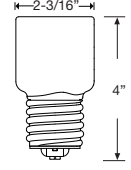
SUPPLIED ACCESSORY		
Description	Picture	Dimensions
Safety Cable		31-1/2"

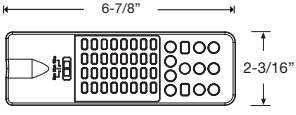
OPTIONAL ACCESSORY ORDERING INFORMATION				
Product	Model	Description	Picture	Dimensions
97718	10SURGE/277V	10 kV Surge Protector for use in outdoor and other applications subject to high surge conditions.		
16325	E26 EXTENDER	E26 Lamp Extender adds 1-5/16" to lamp height.		
35050	E39 EXTENDER	EX39 Lamp Extender adds 1-11/16" to lamp height.		
35521	HID-SEN-REMOTE	Commissioning remote for 135HIDHBSN/xxx/BYP/EX39. One remote required for all 135HIDHBSN/xxx/BYP/EX39 orders.		

Note: All rights reserved. All sizes and specifications are subject to change at any time without notice.