

Project Name:	Type:
Part Number:	Date:



GREENCREATIVE

REFINE PAR FAMILY

FEATURES

- Suitable to replace 50W, 75W, 120W halogen lamps
- Powered by TRUE CHROMA: delivers best in class color accuracy and consistency
- Proprietary designed optic maximizes output, efficacy, color fidelity, and visual comfort
- High CRI and R values (R9 85, R13 95) deliver richer reds and healthier skin tones
- Smooth dimming with existing dimmers*
- Compact size 1:1 halogen form factor
- Spot, Narrow, Flood beam angles
- Suitable for damp locations and totally enclosed fixtures
- Fixture operating temperature: -4°F to 95°F (-20°C to 35°C)
- Lamp ambient temperature: -4°F to 113°F (-20°C to 45°C)
- Rated Lifetime (L70): 50,000hrs
- 5 year limited warranty**



SCAN ME or Click Here

060523



SPECIFICATIONS

Product	Model	Equiv.	Wattage (W)	CCT	Lumens	Efficacy (LPW)	Input Voltage	Beam Angle	CBPCP (cd)	CRI	Dim.*	Power Factor	Base	Fixture Rating	TRUE CHROMA	ES / JA8 / T20
34890	6.5PAR20DIM/927SP15	50W	6.5	2700K	520	80	120V	15°	5,000	95	Yes	0.9	E26	Enclosed	C	√/√/√
34891	6.5PAR20DIM/927NF25	50W	6.5	2700K	560	86	120V	25°	1,800	95	Yes	0.9	E26	Enclosed	C	√/√/√
34892	6.5PAR20DIM/927FL40	50W	6.5	2700K	560	86	120V	40°	1,100	95	Yes	0.9	E26	Enclosed	C	√/√/√
34893	6.5PAR20DIM/930SP15	50W	6.5	3000K	550	85	120V	15°	5,300	95	Yes	0.9	E26	Enclosed	C	√/√/√
34894	6.5PAR20DIM/930NF25	50W	6.5	3000K	580	89	120V	25°	1,900	95	Yes	0.9	E26	Enclosed	C	√/√/√
34895	6.5PAR20DIM/930FL40	50W	6.5	3000K	580	89	120V	40°	1,200	95	Yes	0.9	E26	Enclosed	C	√/√/√
34896	6.5PAR20DIM/940FL40	50W	6.5	4000K	600	92	120V	40°	1,300	95	Yes	0.9	E26	Enclosed	NO	√/√/√
34897	6.5PAR20DIM/930FL40/B	50W	6.5	3000K	580	89	120V	40°	1,200	95	Yes	0.9	E26	Enclosed	C	√/√/√
34898	11PAR30DIM/927SP15	75W	11	2700K	950	86	120V	15°	10,000	95	Yes	0.9	E26	Enclosed	C	√/√/√
34899	11PAR30DIM/927NF25	75W	11	2700K	950	86	120V	25°	4,500	95	Yes	0.9	E26	Enclosed	C	√/√/√
34900	11PAR30DIM/927FL40	75W	11	2700K	950	86	120V	40°	1,700	95	Yes	0.9	E26	Enclosed	C	√/√/√
34901	11PAR30DIM/930SP15	75W	11	3000K	990	90	120V	15°	10,600	95	Yes	0.9	E26	Enclosed	C	√/√/√
34902	11PAR30DIM/930NF25	75W	11	3000K	990	90	120V	25°	4,700	95	Yes	0.9	E26	Enclosed	C	√/√/√
34903	11PAR30DIM/930FL40	75W	11	3000K	990	90	120V	40°	1,750	95	Yes	0.9	E26	Enclosed	C	√/√/√
34904	11PAR30DIM/940FL40	75W	11	4000K	1,030	94	120V	40°	1,850	95	Yes	0.9	E26	Enclosed	NO	√/√/√
34905	11PAR30DIM/930FL40/B	75W	11	3000K	990	90	120V	40°	1,750	95	Yes	0.9	E26	Enclosed	C	√/√/√
34906	11PAR30SNDIM/927SP15	75W	11	2700K	950	86	120V	15°	10,000	95	Yes	0.9	E26	Enclosed	C	√/√/√
34907	11PAR30SNDIM/927NF25	75W	11	2700K	950	86	120V	25°	4,500	95	Yes	0.9	E26	Enclosed	C	√/√/√
34908	11PAR30SNDIM/927FL40	75W	11	2700K	950	86	120V	40°	1,700	95	Yes	0.9	E26	Enclosed	C	√/√/√
34909	11PAR30SNDIM/930SP15	75W	11	3000K	990	90	120V	15°	10,600	95	Yes	0.9	E26	Enclosed	C	√/√/√
34910	11PAR30SNDIM/930NF25	75W	11	3000K	990	90	120V	25°	4,700	95	Yes	0.9	E26	Enclosed	C	√/√/√
35939	11PAR30SNDIM/930NF25/B	75W	11	3000K	990	90	120V	25°	4,700	95	Yes	0.9	E26	Enclosed	C	√/√/√
34911	11PAR30SNDIM/930FL40	75W	11	3000K	990	90	120V	40°	1,750	95	Yes	0.9	E26	Enclosed	C	√/√/√
34912	11PAR30SNDIM/940FL40	75W	11	4000K	1,030	94	120V	40°	1,850	95	Yes	0.9	E26	Enclosed	NO	√/√/√
34913	11PAR30SNDIM/930FL40/B	75W	11	3000K	990	90	120V	40°	1,750	95	Yes	0.9	E26	Enclosed	C	√/√/√



REFINE PAR FAMILY

SPECIFICATIONS																
Product	Model	Equiv.	Wattage (W)	CCT	Lumens	Efficacy (LPW)	Input Voltage	Beam Angle	CBCP (cd)	CRI	Dim.*	Power Factor	Base	Fixture Rating	TRUE CHROMA	ES/JA8/T20
34916	15.5PAR38DIM/927SP15	120W	15.5	2700K	1,320	85	120V	15°	14,000	95	Yes	0.9	E26	Enclosed		√/√/√
34917	15.5PAR38DIM/927NF25	120W	15.5	2700K	1,320	85	120V	25°	6,750	95	Yes	0.9	E26	Enclosed		√/√/√
34918	15.5PAR38DIM/927FL40	120W	15.5	2700K	1,320	85	120V	40°	2,800	95	Yes	0.9	E26	Enclosed		√/√/√
34919	15.5PAR38DIM/930SP15	120W	15.5	3000K	1,370	88	120V	15°	14,700	95	Yes	0.9	E26	Enclosed		√/√/√
34920	15.5PAR38DIM/930NF25	120W	15.5	3000K	1,370	88	120V	25°	7,000	95	Yes	0.9	E26	Enclosed		√/√/√
34921	15.5PAR38DIM/930FL40	120W	15.5	3000K	1,370	88	120V	40°	2,900	95	Yes	0.9	E26	Enclosed		√/√/√
34922	15.5PAR38DIM/940FL40	120W	15.5	4000K	1,420	92	120V	40°	3,000	95	Yes	0.9	E26	Enclosed	NO	√/√/√
34923	15.5PAR38DIM/930NF25/B	120W	15.5	3000K	1,370	88	120V	25°	7,000	95	Yes	0.9	E26	Enclosed		√/√/√
34924	15.5PAR38DIM/930FL40/B	120W	15.5	3000K	1,370	88	120V	40°	2,900	95	Yes	0.9	E26	Enclosed		√/√/√
34925	15.5PAR38DIM/930FL40/GU24	120W	15.5	3000K	1,370	88	120V	40°	2,900	95	Yes	0.9	GU24	Enclosed		√/√/√
34914	11PAR30/930FL40/277V	75W	11	3000K	990	90	120-277V	40°	1,750	95	No	0.9	E26	Enclosed		√/NA./√
34915	11PAR30/940FL40/277V	75W	11	4000K	1,030	94	120-277V	40°	1,850	95	No	0.9	E26	Enclosed	NO	√/NA./√
34926	15.5PAR38/930FL40/277V	120W	15.5	3000K	1,370	88	120-277V	40°	2,900	95	No	0.9	E26	Enclosed		√/NA./√
34927	15.5PAR38/940FL40/277V	120W	15.5	4000K	1,420	92	120-277V	40°	3,000	95	No	0.9	E26	Enclosed	NO	√/NA./√

*This lamp might not be compatible with all dimmers. Please visit www.greencreative.com for compatibility information.

**Please visit www.greencreative.com for Limited Warranty terms.

DIMENSIONS & WEIGHT

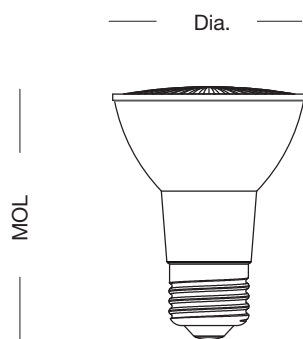

Model	Base	MOL	Dia.	Weight
6.5PAR20DIM/927SP15	E26	3-1/4"	2-1/2"	0.18lb
6.5PAR20DIM/927NF25	E26	3-1/4"	2-1/2"	0.18lb
6.5PAR20DIM/927FL40	E26	3-1/4"	2-1/2"	0.18lb
6.5PAR20DIM/930SP15	E26	3-1/4"	2-1/2"	0.18lb
6.5PAR20DIM/930NF25	E26	3-1/4"	2-1/2"	0.18lb
6.5PAR20DIM/930FL40	E26	3-1/4"	2-1/2"	0.18lb
6.5PAR20DIM/940FL40	E26	3-1/4"	2-1/2"	0.18lb
6.5PAR20DIM/930FL40/B	E26	3-1/4"	2-1/2"	0.18lb

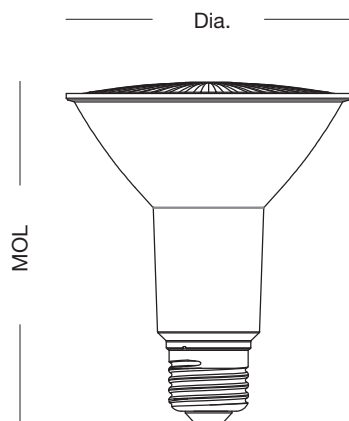

Model	Base	MOL	Dia.	Weight
11PAR30DIM/927SP15	E26	4-7/16"	3-11/16"	0.31lb
11PAR30DIM/927NF25	E26	4-7/16"	3-11/16"	0.31lb
11PAR30DIM/927FL40	E26	4-7/16"	3-11/16"	0.31lb
11PAR30DIM/930SP15	E26	4-7/16"	3-11/16"	0.31lb
11PAR30DIM/930NF25	E26	4-7/16"	3-11/16"	0.31lb
11PAR30DIM/930FL40	E26	4-7/16"	3-11/16"	0.31lb
11PAR30DIM/940FL40	E26	4-7/16"	3-11/16"	0.31lb
11PAR30DIM/930FL40/B	E26	4-7/16"	3-11/16"	0.31lb
11PAR30/930FL40/277V	E26	4-7/16"	3-11/16"	0.33lb
11PAR30/940FL40/277V	E26	4-7/16"	3-11/16"	0.33lb



REFINE PAR FAMILY

DIMENSIONS & WEIGHT

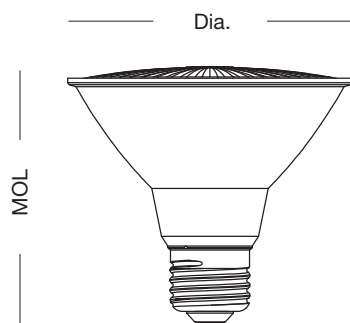

Model	Base	MOL	Dia.	Weight
11PAR30SNDIM/927SP15	E26	3-1/4"	3-11/16"	0.3lb
11PAR30SNDIM/927NF25	E26	3-1/4"	3-11/16"	0.3lb
11PAR30SNDIM/927FL40	E26	3-1/4"	3-11/16"	0.3lb
11PAR30SNDIM/930SP15	E26	3-1/4"	3-11/16"	0.3lb
11PAR30SNDIM/930NF25	E26	3-1/4"	3-11/16"	0.3lb
11PAR30SNDIM/930NF25/B	E26	3-1/4"	3-11/16"	0.3lb
11PAR30SNDIM/930FL40	E26	3-1/4"	3-11/16"	0.3lb
11PAR30SNDIM/940FL40	E26	3-1/4"	3-11/16"	0.3lb
11PAR30SNDIM/930FL40/B	E26	3-1/4"	3-11/16"	0.3lb

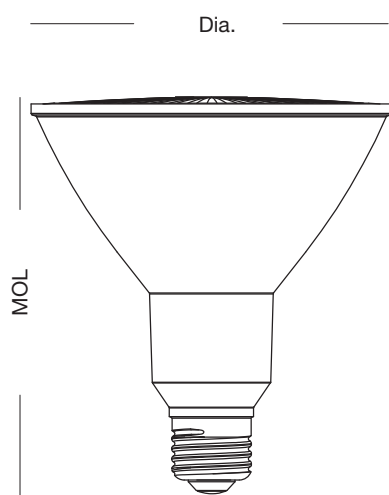

Model	Base	MOL	Dia.	Weight
15.5PAR38DIM/927SP15	E26	5-1/8"	4-5/8"	0.52lb
15.5PAR38DIM/927NF25	E26	5-1/8"	4-5/8"	0.52lb
15.5PAR38DIM/927FL40	E26	5-1/8"	4-5/8"	0.52lb
15.5PAR38DIM/930SP15	E26	5-1/8"	4-5/8"	0.52lb
15.5PAR38DIM/930NF25	E26	5-1/8"	4-5/8"	0.52lb
15.5PAR38DIM/930FL40	E26	5-1/8"	4-5/8"	0.52lb
15.5PAR38DIM/940FL40	E26	5-1/8"	4-5/8"	0.52lb
15.5PAR38DIM/930NF25/B	E26	5-1/8"	4-5/8"	0.52lb
15.5PAR38DIM/930FL40/B	E26	5-1/8"	4-5/8"	0.52lb
15.5PAR38DIM/930FL40/GU24	GU24	5-1/8"	4-5/8"	0.54lb
15.5PAR38/930FL40/277V	E26	5-1/8"	4-5/8"	0.52lb
15.5PAR38/940FL40/277V	E26	5-1/8"	4-5/8"	0.52lb

MINIMUM COMPARTMENT DIMENSIONS

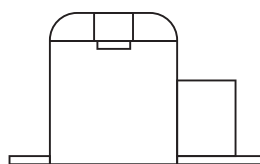

Enclosed Fixture

Diameter	Height
6"	8-1/2"



REFINE PAR FAMILY

ILLUMINANCE & CANDELA DISTRIBUTION

6.5PAR20DIM/930SP15

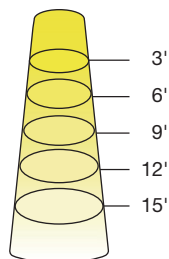

Diameter	Footcandles
0.8	589
1.6	147
2.4	65
3.2	37
3.9	24

6.5PAR20DIM/930NF25

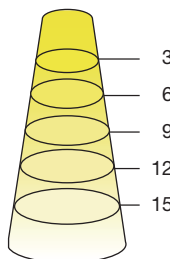

Diameter	Footcandles
1.3	211
2.7	53
4.0	23
5.3	13
6.7	8

6.5PAR20DIM/930FL40

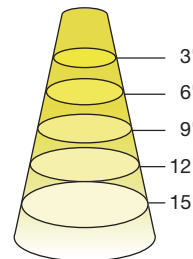

Diameter	Footcandles
2.2	133
4.4	33
6.6	15
8.7	8
10.9	5

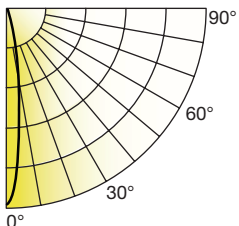

Degree	Candela
0	5300
5	3488
15	564
25	170
35	74
45	40

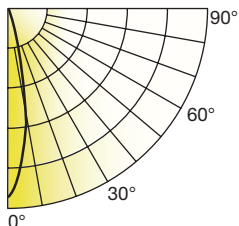

Degree	Candela
0	1900
5	1589
15	638
25	219
35	94
45	51

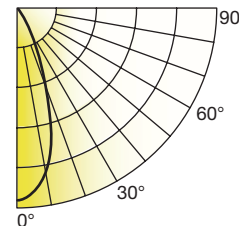

Degree	Candela
0	1200
5	1100
15	725
25	365
35	174
45	76

11PAR30DIM/930SP15

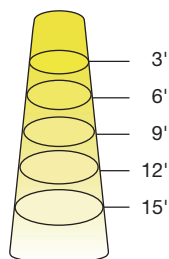

Diameter	Footcandles
0.8	1,178
1.6	294
2.4	131
3.2	74
3.9	47

11PAR30DIM/930NF25

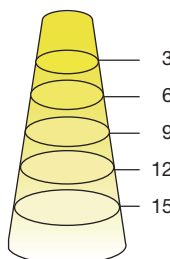

Diameter	Footcandles
1.3	522
2.7	131
4.0	58
5.3	33
6.7	21

11PAR30DIM/930FL40

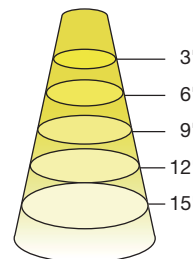

Diameter	Footcandles
2.2	194
4.4	49
6.6	22
8.7	12
10.9	8

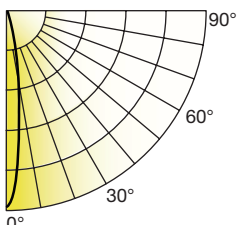

Degree	Candela
0	10,600
5	7,008
15	958
25	174
35	102
45	68

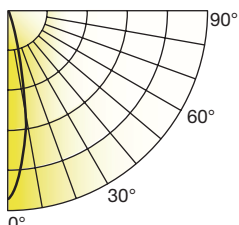

Degree	Candela
0	4,700
5	3,841
15	1,157
25	213
35	81
45	56

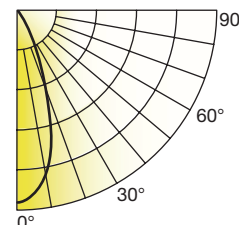

Degree	Candela
0	1,750
5	1,636
15	991
25	592
35	217
45	64



REFINE PAR FAMILY

ILLUMINANCE & CANDELA DISTRIBUTION

11PAR30SNDIM/930SP15

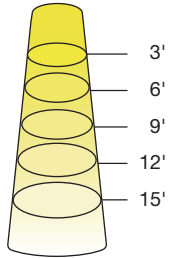

Diameter	Footcandles
0.8	1,178
1.6	294
2.4	131
3.2	74
3.9	47

11PAR30SNDIM/930NF25

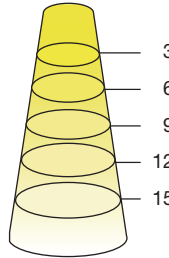

Diameter	Footcandles
1.3	522
2.7	131
4.0	58
5.3	33
6.7	21

11PAR30SNDIM/930FL40

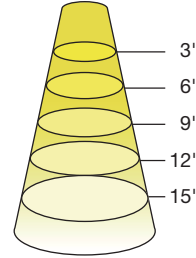

Diameter	Footcandles
2.2	194
4.4	49
6.6	22
8.7	12
10.9	8

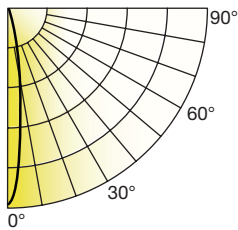

Degree	Candela
0	10,600
5	7,008
15	958
25	174
35	102
45	68

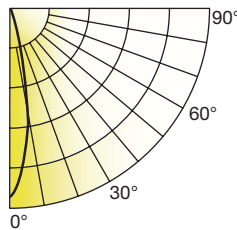

Degree	Candela
0	4,700
5	3,841
15	1,157
25	213
35	81
45	56

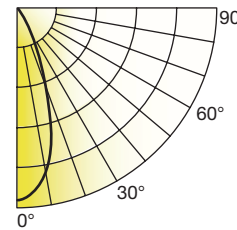

Degree	Candela
0	1,750
5	1,636
15	991
25	592
35	217
45	64

15.5PAR38DIM/930SP15

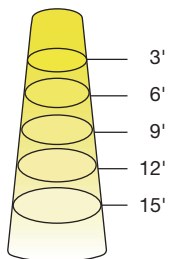

Diameter	Footcandles
0.8	1,633
1.6	408
2.4	181
3.2	102
3.9	65

15.5PAR38DIM/930NF25

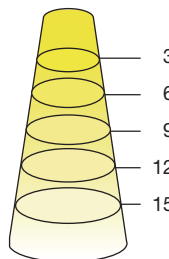

Diameter	Footcandles
1.3	778
2.7	194
4.0	86
5.3	49
6.7	31

15.5PAR38DIM/930FL40

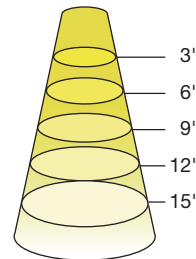

Diameter	Footcandles
2.2	322
4.4	81
6.6	36
8.7	20
10.9	13

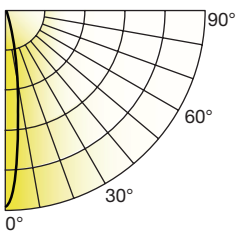

Degree	Candela
0	14,700
5	9,095
15	1,435
25	256
35	93
45	58

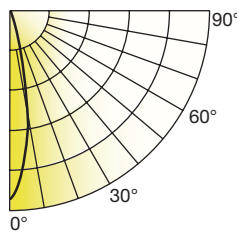

Degree	Candela
0	7,000
5	6,095
15	1,658
25	408
35	137
45	64

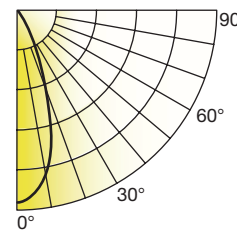

Degree	Candela
0	2,900
5	2,845
15	1,813
25	929
35	300
45	78

For other CCT use the following multiplier: 2700K .98, 4000K 1.02



REFINE PAR FAMILY

COLOR ACCURACY & SPECTRAL POWER DISTRIBUTION

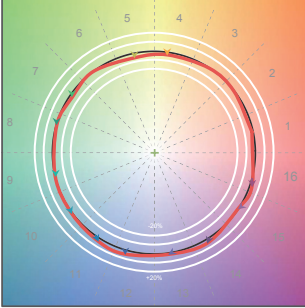
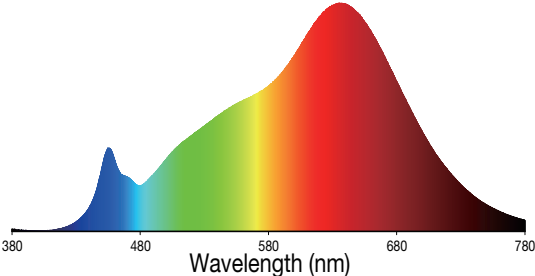
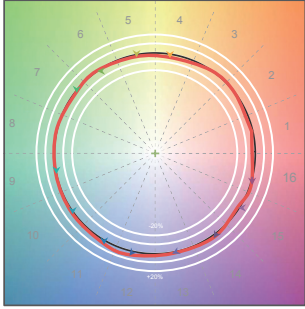
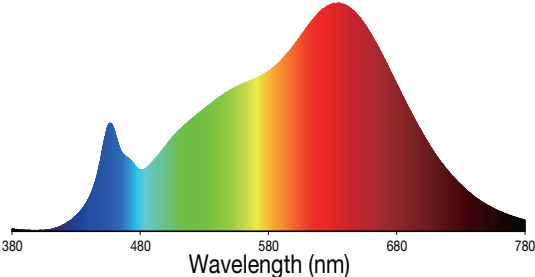
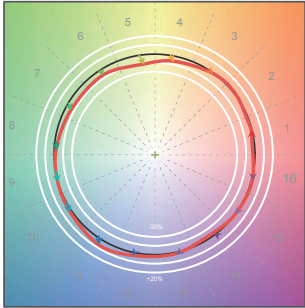
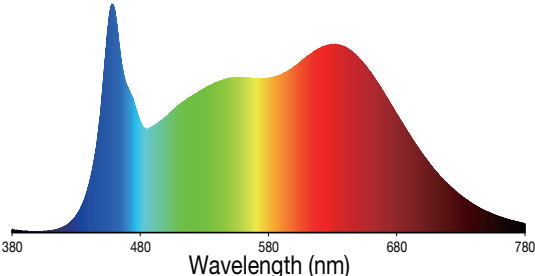
CCT	COLOR ACCURACY	SPECTRAL POWER DISTRIBUTION
2700K	 <p>Rr: 95, Rg: 100</p>	 <p>Wavelength (nm)</p>
3000K	 <p>Rr: 94, Rg: 99</p>	 <p>Wavelength (nm)</p>
4000K	 <p>Rr: 90, Rg: 97</p>	 <p>Wavelength (nm)</p>

Rf: TM-30 metric measuring color fidelity (whether colors are similar to those under natural light). Rf is a more accurate version of the CRI Ra. Rf is 100 for natural light.

Rg: TM-30 metric measuring color gamut (whether colors are more saturated than under natural light). Rg is 100 for natural light.



REFINE PAR FAMILY

ORDERING INFORMATION

Model	Master Carton			Shipping Carton		
	Case Qty	Case Dimensions (LxWxH)	Case Weight	Case Qty	Case Dimensions (LxWxH)	Case Weight
6.5PAR20DIM/xxxxyy	6	8-3/16" x 5-1/2" x 3-15/16"	1.54lb	24	11-7/16" x 8-3/4" x 8-7/8"	6.83lb
6.5PAR20DIM/930FL40/B	6	8-3/16" x 5-1/2" x 3-15/16"	1.54lb	24	11-7/16" x 8-3/4" x 8-7/8"	6.83lb
11PAR30DIM/927SP15	6	11-15/16" x 8-1/8" x 5-3/8"	2.65lb	24	16-7/16" x 12-1/4" x 11-13/16"	12.35lb
11PAR30DIM/930FL40/B	6	11-15/16" x 8-1/8" x 5-3/8"	2.65lb	24	16-7/16" x 12-1/4" x 11-13/16"	12.35lb
11PAR30SDIM/927SP15	6	11-15/16" x 8-1/8" x 5-3/8"	1.98lb	24	16-3/8" x 12-1/2" x 9-11/16"	11.46lb
11PAR30SDIM/930FL40/B	6	11-15/16" x 8-1/8" x 5-3/8"	1.98lb	24	16-3/8" x 12-1/2" x 9-11/16"	11.46lb
11PAR30/930FL40/277V	6	11-15/16" x 8-1/8" x 5-3/8"	2.65lb	24	16-7/16" x 12-1/4" x 11-13/16"	12.35lb
15.5PAR38DIM/927SP15	6	14-15/16" x 10-1/16" x 6-1/4"	4.41lb	24	20-7/16" x 15-7/16" x 13-5/8"	19.62lb
15.5PAR38DIM/xxxxyy/B	6	14-15/16" x 10-1/16" x 6-1/4"	4.41lb	24	20-7/16" x 15-7/16" x 13-5/8"	19.62lb
15.5PAR38DIM/xxxxyy/GU24	6	14-15/16" x 10-1/16" x 6-1/4"	4.41lb	24	20-7/16" x 15-7/16" x 13-5/8"	19.62lb
15.5PAR38/xxxxyy/277V	6	14-15/16" x 10-1/16" x 6-1/4"	4.41lb	24	20-7/16" x 15-7/16" x 13-5/8"	19.62lb
11PAR30SDIM/xxxxyy/B	6	11-15/16" x 8-1/8" x 9-3/8"	1.98lb	24	16-3/8" x 12-1/2" x 9-11/16"	11.46lb

Where xxx means 824-965 which indicates CRI and color temperature

Where yyyy means beam angle

Note: All rights reserved. All sizes and specifications are subject to change at any time without notice.