

TE223LED, 3-LIGHT TRIMLESS LED MULTIPLE RECESS

PRODUCT DETAILS

No.	:	TE223LED-35-2-01
Product Color	:	BLACK
Length	:	18.375"
Width	:	6.25"
Height	:	7"



LIGHT SOURCE DETAILS

Light Source Type	:	INTEGRATED LED
Input Voltage	:	120V
Bulb Voltage	:	120V
Socket Type	:	LED
Total Wattage	:	78W
Total Lumen	:	7500lm
Kelvin	:	3500K
CRI	:	90
Dimmable	:	Yes

Options Available

ITEM NO.	FINISH	SHADE
TE223LED-35-2-01	BLACK	
TE223LED-35-2-02	WHITE	

TECHNICAL DETAILS

Driver	:	Inventronics 35W Current Driver
Location	:	DRY
Approval	:	 ETL
Beam Angle	:	20
Cut Hole Length	:	18.625"
Cut Hole Width	:	6.5"

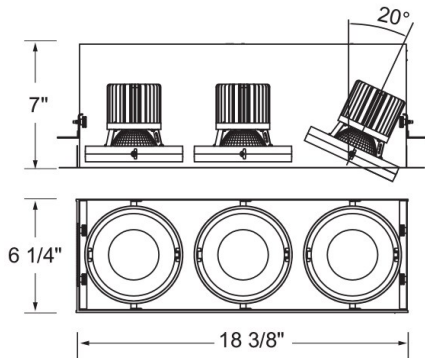

PROJECT INFORMATION

Job Name: Date: Type:

Comments: