

TE164ALED, 4-LIGHT LINEAR LED MULTIPLE RECESS

PRODUCT DETAILS

No.	:	TE164ALED-40-2-01
Product Color	:	BLACK
Shade / Accent Colour	:	BLACK
Length	:	18.375"
Width	:	6.125"
Height	:	6.3125"
Weight	:	6lbs



LIGHT SOURCE DETAILS

Light Source Type	:	INTEGRATED LED
Input Voltage	:	120V
Bulb Voltage	:	120V
Socket Type	:	LED
Total Wattage	:	60W
Total Lumen	:	5160lm
Kelvin	:	4000K
CRI	:	90
Dimmable	:	Yes

Options Available

ITEM NO.	FINISH	SHADE
TE164ALED-40-2-01	BLACK	BLACK
TE164ALED-40-2-02	WHITE	BLACK
TE164ALED-40-2-0N	PLATINUM	BLACK
TE164ALED-40-2-22	WHITE	WHITE

TECHNICAL DETAILS

Driver	:	ES 16.8W Current Driver
Location	:	DRY
Approval	:	
Beam Angle	:	20
Cut Hole Length	:	17.375"
Cut Hole Width	:	5.125"

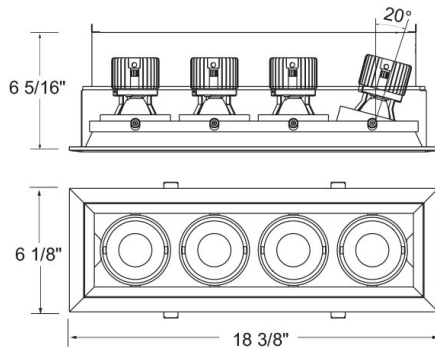

PROJECT INFORMATION

 Job Name: Date: Type:

 Comments: