

TE162LED, 2-LIGHT LED MULTIPLE RECESS



PRODUCT DETAILS

No.	:	TE162LED-40-4-01
Product Color	:	BLACK
Shade / Accent Colour	:	BLACK
Length	:	10.4375"
Width	:	6.125"
Height	:	6.3125"

LIGHT SOURCE DETAILS

Light Source Type	:	INTEGRATED LED
Input Voltage	:	120V
Bulb Voltage	:	120V
Socket Type	:	LED
Total Wattage	:	30W
Total Lumen	:	2580lm
Kelvin	:	4000K
CRI	:	90
Dimmable	:	Yes

Options Available

ITEM NO.	FINISH	SHADE
TE162LED-40-4-01	BLACK	BLACK
TE162LED-40-4-02	WHITE	BLACK
TE162LED-40-4-0N	PLATINUM	BLACK
TE162LED-40-4-22	WHITE	WHITE

TECHNICAL DETAILS

Driver	:	ES 16.8W Current Driver
Location	:	DRY
Approval	:	
Beam Angle	:	40
Cut Hole Length	:	9.5"
Cut Hole Width	:	5.125"

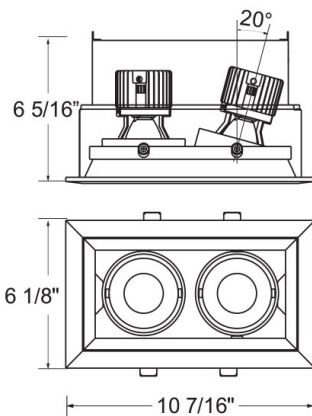

PROJECT INFORMATION

 Job Name: Date: Type:

 Comments: