

TE133LED, 3-LIGHT LED MULTIPLE RECESS

PRODUCT DETAILS

No.	:	TE133LED-40-4-02
Product Color	:	WHITE
Shade / Accent Colour	:	BLACK
Length	:	18.8125"
Width	:	7.75"
Height	:	7"
Weight	:	7lbs

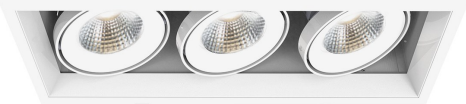

LIGHT SOURCE DETAILS

Light Source Type	:	INTEGRATED LED
Input Voltage	:	120V
Bulb Voltage	:	120V
Socket Type	:	LED
Total Wattage	:	78W
Initial Lumens	:	7500lm
Kelvin	:	4000K
CRI	:	90
Dimmable	:	Yes

OPTIONS AVAILABLE

ITEM NO.	FINISH	SHADE
TE133LED-40-4-01	BLACK	BLACK
TE133LED-40-4-02	WHITE	BLACK
TE133LED-40-4-0N	PLATINUM	BLACK
TE133LED-40-4-22	WHITE	WHITE

TECHNICAL DETAILS

Driver	:	Inventronics 35W Current Driver
Location	:	DRY
Approval	:	
Title 24	:	Yes
Beam Angle	:	40
Cut Hole Length	:	18"
Cut Hole Width	:	6.75"

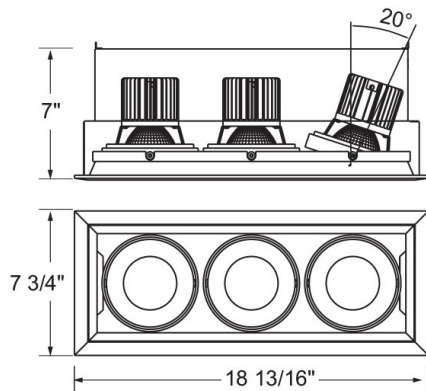

PROJECT INFORMATION

 Job Name: Date: Category:

 Comments: