

2-HEAD LED SECURITY LIGHT

MODEL# 51405144 | 2544LUMENS | 28W | 94LPW | 4000K



2-HEAD LED SECURITY LIGHT

SUPERIOR VALUE & PERFORMANCE



PRODUCT OVERVIEW

ETi SSL's 2-Head LED Security Light has a lumen boost function which can be used to increase lighting coverage from 1200 Lumens to 2400 Lumens for broad and fuller light intensity. The light showcases a sensor which detects light or lack of light in specific areas and will ensure safety and awareness, preventing possible injuries and increase property value. Its dusk-to-dawn function can be used to control the lights to automatically turn on or off, or the included photocell cover can be used to control the fixture by switch. The 2-Head Security LED Light emits 28-watts of energy-efficient and cool emissions of premium LED technology conserving electricity, the environment, and your wallet.

Installation is easy due to its mounting bracket, and it highlights a toolless adjustability, enabling you to point heads in a desired direction. The 2-Head Security LED Light is maintenance-free, so there is no need to climb ladders to replace bulbs. Because of its housing of lightweight aluminum, it is suitable for wet locations.

Our entire team takes great pride in our dedication to providing innovative in-stock lighting solutions that typically ship in 2-3 days with the product reliability and quality that you can always depend on from ETi SSL.

STOCK ORDERING INFORMATION (typical 2-3 day shipment lead time)¹

| Catalog Logic/PT# | Model # | UPC | Lumens ² | Wattage | LPW | CCT | CRI | Voltage | Dimming | Energy Star ³ |
|--------------------------|----------|--------------|---------------------|---------|-----|-------|----------|---------|---------|--------------------------|
| SC-2HD-2400LM-8-40K-SV-W | 51405144 | 849489065687 | 2544lm | 26.9 | 94 | 4000K | 80 (min) | 120V | Non-Dim | Yes |

Notes:

1. Stock SKUs typically ship in 24-48 hours upon receipt of an approved released order.

2. This unit has Lumen Boost settings from 50% (1200 nominal lumens) to 100% (2400 nominal lumens). This unit test results are for the highest setting (2544lm).

3. Search first 6-digits of the model # followed by '###' on the ENERGY STAR® website database...(Ex: '514051##') to view certifications.







SC Series

2-Head LED Security Light

Model# 51405144 | 2544 Lumens | 28W | 94LPW | 4000K | ENERGY STAR® | 5-yr Warranty

CATALOG LOGIC | PART# DECODER^{1,2,3}

SC-2HD-2400LM-8-40K-SV-W (Model # 51405144)

| | | | | | | |
|---|---|---|---|--|---|---|
|  |  |  |  |  |  |  |
| Series | Size | Lumens ³ | CRI | CCT | Voltage | White |
| SC Security Light | 2HD 2-Head | 2400LM Nominal Lumens | 8 80CRI (minimum) | 40K 4000K | SV Single Voltage (120V) | W White Finish |

Notes:

1. This product is not configurable, only designated 'Stock' SKUs are available.
2. Decoder is to help clarify Catalog Logic | Part # configurations only (see Stock & Rapid Ship Ordering Information for available SKUs).
3. Lumen values shown are nominal (see Stock Ordering Information or Photometric Details sections for additional performance details).

KEY DIMENSIONAL INFORMATION

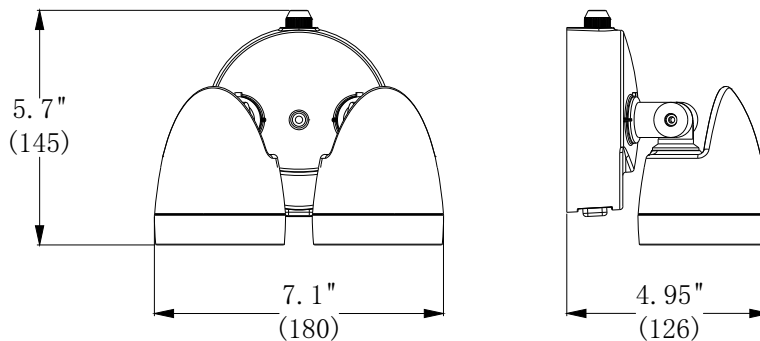

Note: All dimensions are shown in inches (millimeters).

MISCELLANEOUS PRODUCT SPECS & DETAILS

Load Information

| | |
|-----------------------|-----------------|
| Power Factor | > 0.9775 |
| THD | < 41% |
| Frequency | 60 Hz |
| Sound Rating | < 20 Dba |
| Low Temp Start | -40° C (-40° F) |
| Max Temp | 45° C (113° F) |
| Unit Weight | 1.92 lbs |

Lumen Maintenance

| Ambient Temperature | TM-21 Lumen Maintenance (60,000 hours) |
|---------------------|--|
| 25° C (77° F) | > 88.25% |
| Ambient Temperature | TM-21 Theoretical L70 (hours) |
| 25° C (77° F) | 168,000 |

Shipping Information*

| Size | Unit Weight ¹ | Pallet ² |
|-------------|--------------------------|---------------------|
| 2-Head Unit | 2.29 lbs | 84 units |

1. Case pack weighs 10.25lbs (4 units / per case pack).
2. There are 42 case packs per pallet.

PHOTOMETRIC DETAILS

Luminaire Data: SC-2HD-2400LM-8-40K-SV-W

| | |
|---------------------------------|------------------------------|
| IES File Name | 51405143_51405144.IES |
| CCT & CRI | 4000K, 80CRI minimum |
| Initial Delivered Lumens | 2,544 |
| Wattage | 26.97W |
| Efficacy | 94 |
| Beam Angle | 50% = 72° 10% = 120° |
| Spacing | 0° = 1.10 90° = 1.20 |

Photometric values based on tests performed in compliance with LM-63 & LM-79

Indoor Candela Plot

