

Trimless Surface Mount

The NEW EnVision LED Trimless Surface Mount is ultra thin, easy to install, and ideal for any residential or commercial recessed setting. The fixture has various mounting options making it easy to retrofit an existing fixture or install in a new construction setting. With our elegant and minimal design, which blends seamlessly into the ceiling, these trimless surface mounts are sure to turn some heads.



Applications:

- Residential or Commercial Lighting
- New Construction or Remodel Use
- General Recessed Lighting

Product Information:

- Stocked in 30K; other CCT available with lead time
- Di-cast aluminum housing for better heat dissipation
- Available in white, black, brushed nickel finish
- Closet Rated according to NEC Section 410.6 & 410.8
- Optional Emergency Backup Available: delivers full lumens in EM mode
- L70 @ 50,000 Hours lumen maintenance

Detail Specifications:

- Wet Location Rated
- CRI 90 LED Chip, R9>50
- 120V Driver
- 100° Beam Angle
- Operating Temperature: 0°F ~ +113°F
- PF >0.9
- Triac and ELV Dimmable Down to 5%

Mounting:

- Compatible with 3O or 4O J-Box (req's 0.7" room in box)
- Option recessed can converter accessories available: (5" works in 4" can / 7", 9", 11" works in 6" can)

Certifications:

- ETL Listed for USA and CA
- Energy Star
- IC Rated and ASTM-E283 Air-Tight
- CA Title 24 JA8-2019 CEC Listed
- FCC CFR 47, FCC Part 15, Subpart B:2017
- 5 Year EnVision LED Limited Warranty

What's Included:

- LED Fixture
- Junction Box Mounting Plate
- Mounting Screws
- Installation Guide
- Recessed can converter available for separate purchase

LED - TSM - Size/Wattage - **30K** - Finish - **EMB** - **5YR**

1 2 3 4 5 6

1 Product

LED-TSM Trimless Surface Mount

2 Size/Wattage

5-12W 5" - 12W (850 Lumens)
7-15W 7" - 15W (1,100 Lumens)
9-18W 9" - 18W (1,300 Lumens)
11-20W 11" - 20W (1,500 Lumens)

3 Color

30K 3000K

4 Finish

WH White
BLK Black
BN Brushed Nickel

5 EMB

(Blank) None
EMB Emergency Backup

6 Warranty

5YR 5 Years (Incl.)

Specs and model numbers are subject to change with or without notice. Customization of product is available.

Flawless Brilliance

Precisely optimized LED array delivers smooth, uniform illumination with no visible dark spots

Dimming Capability

This fixture is compatible with industry standard TRIAC/ELV dimmers, being able to dim from 10% - 100%

Clearly Different

Specilized lens transmit clear, beautiful light with a subtle diffusion

Designed to Disappear

Extends just 0.6" below the ceiling plane to minimize visual profile

Seamless Integration

Elegant, minimal design blends seamlessly into the ceiling

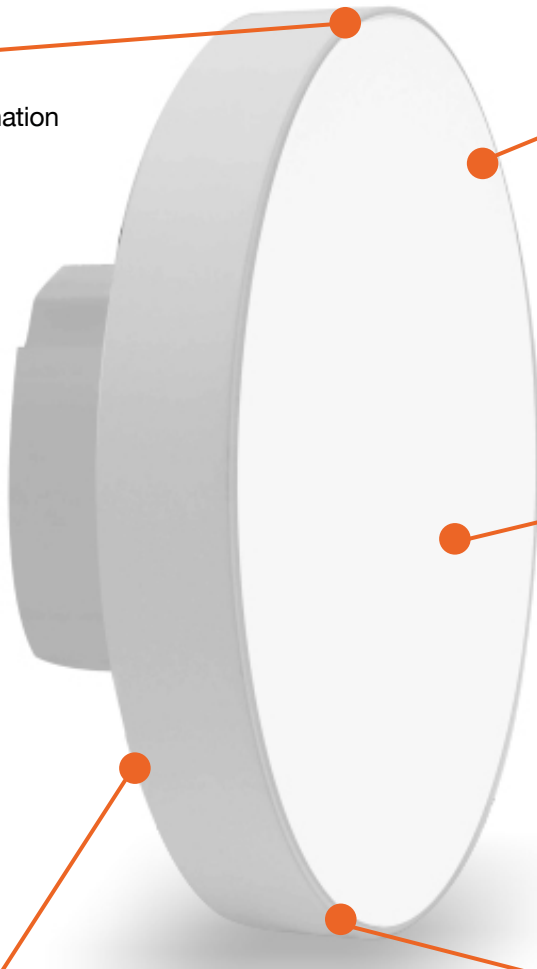

DIMENSIONS

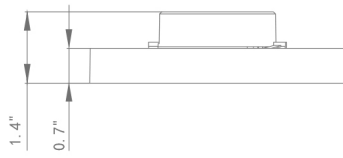
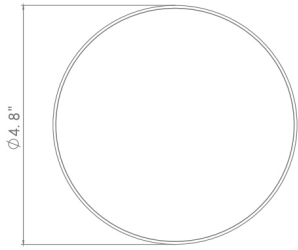

5in Round

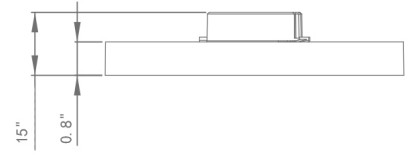
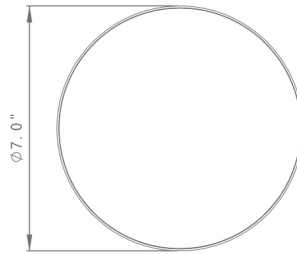

7in Round

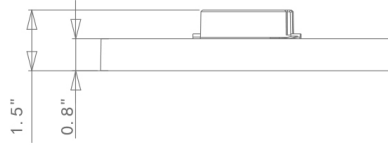
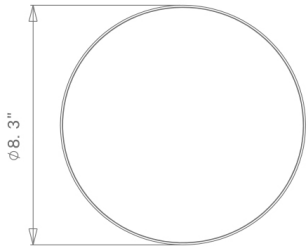

9in Round

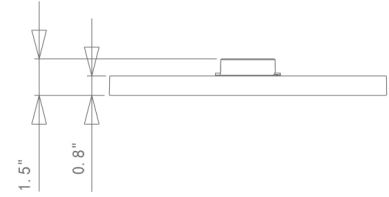
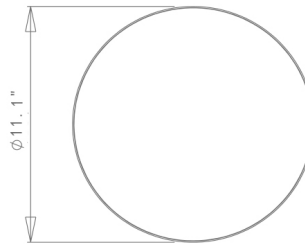

11in Round

DUAL INSTALLATION

3/4" J-Box (For all models)

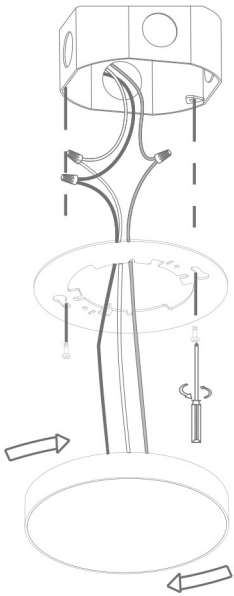

4" Housing (For 5 in model)

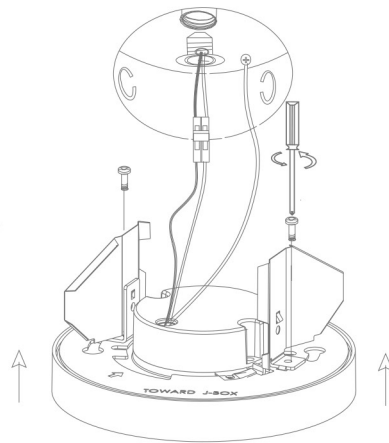

5"6" Housing (For 7/9/11 in model)

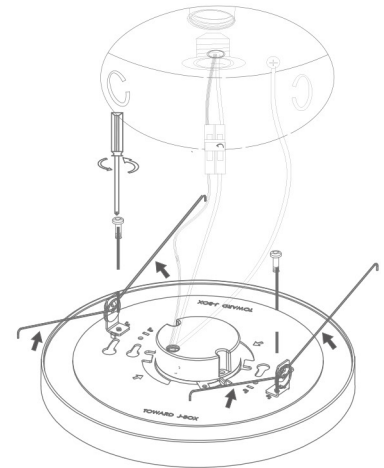

Accessories included:
Attach mounting bracket to J-box Click downlight into mounting bracket



E26 Adapter

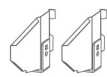

Mounting Clips for 5"

Accessories sold separately:
Connect E26 adapter to the LED adapter Insert mounting clips and push downlight up until flush with ceiling



Mounting Bracket



Wire Nuts



J-Box Screws



E26 Adapter

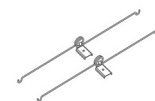

Mounting Clips for 7"/9"/11"



Mounting Bracket

FEATURES