



2x2



2x4

## Center Basket Troffer

The EnVision LED Center Basket Troffer Series are different from standard troffer in the market. The PC housing makes it unique because it is light, doesn't get damaged or get dings in transit or at the job site, and provides a much cleaner and uniformed light distribution when lit. In addition, EnVision's troffer features a u-shaped heat sink inside in order to spread the beam distribution and give the fixture backlight. Retrofit existing fluorescent troffers used in drop ceilings, enjoy minimal power consumption, long lifespan, and bright illumination.

### Applications:

- Commercial lighting
- Office lighting
- Fluorescent retrofitting
- Surface mount, Recessed lighting, T-Bar and lay-in

### Product Information:

- Flicker-Free 0-10V dimmable internal driver
- Up to 56% higher efficiency than fluorescent
- Emergency backup model allows for easy installation
- Three color temperature available: 3500k, 4000k and 5000k
- Variable color temperature & brightness model available: 3000k, 3500k, 4000k and 5000k

LED-CBT	Size	PC-CCT	CRI	Options	Warranty	Accessories
1	2	3	4	5	6	7

1 Product	2 Size	3 PC-CCT	4 CRI	5 Options	6 Warranty	7 Accessories
LED-CBT	2x2 24"x 24" 2x4 24"x48"	2x2 20W : 2,600lm 25W : 3,250lm 30W : 3,900lm 35W : 4,550lm  2x4 35W : 4,550lm 40W : 5,200lm 45W : 5,850lm 50W : 6,500lm CCT: 30/35/40/50K	Blank CRI-80 CRI90 CRI-90	BMS Bi-Level Motion Sensor EMB Emergency Back-Up BT Bluetooth	Blank 5 Years (Included)	(Blank) None 2X2-SM-3.5" 2X2 Surface Mount Frame 2X4-SM-3.5" 2X4 Surface Mount Frame LED-PNL-2X2-FLNG 2X2 Flange Drywall Kit LED-PNL-2X4-FLNG 2X4 Flange Drywall Kit FLX-WHIP-6'-5/6 6' Flexible Whip 5-Non EMB / 6 EMB

Specs and model numbers are subject to change with or without notice. Customization of product is available.

**DIMENSIONS**

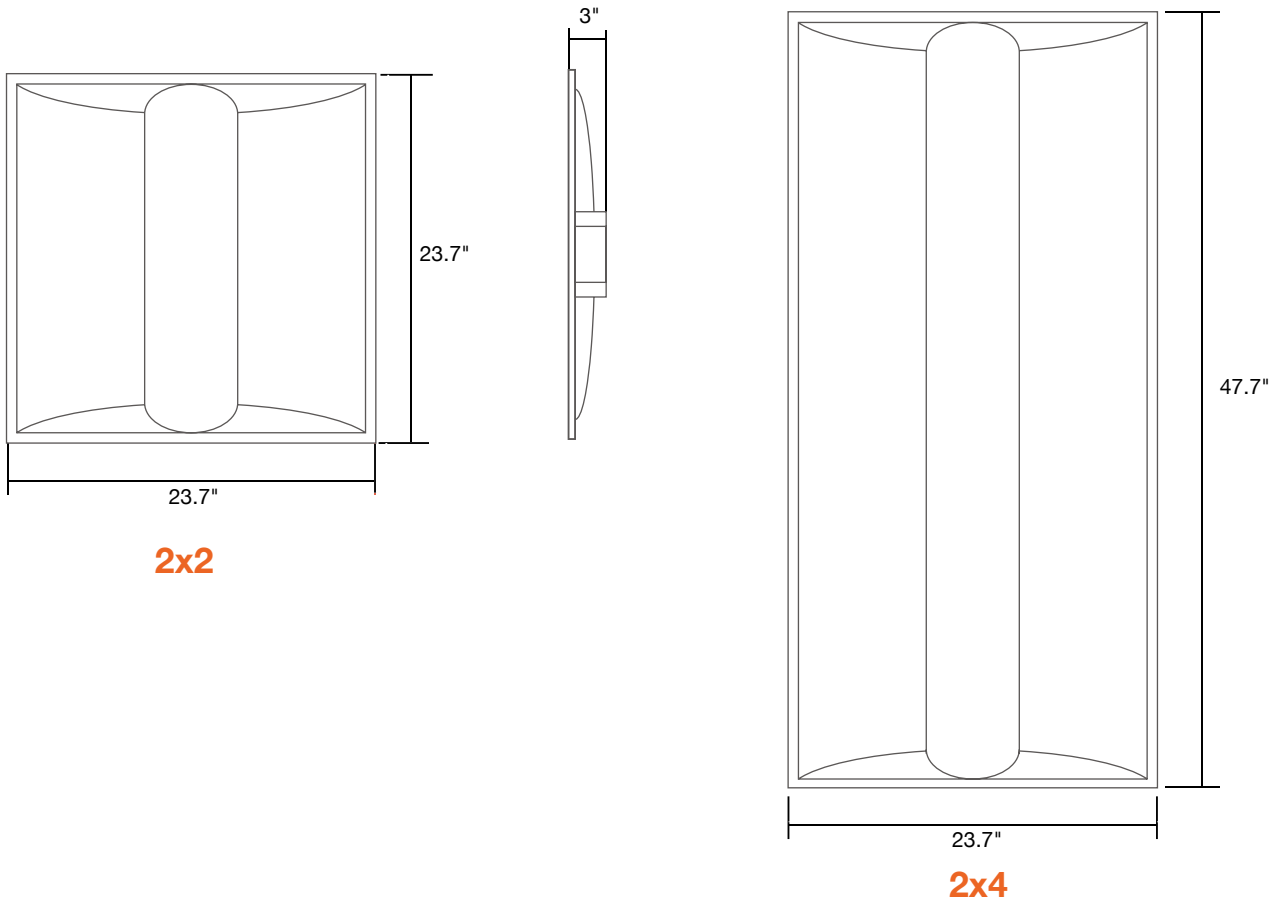

**FEATURES**

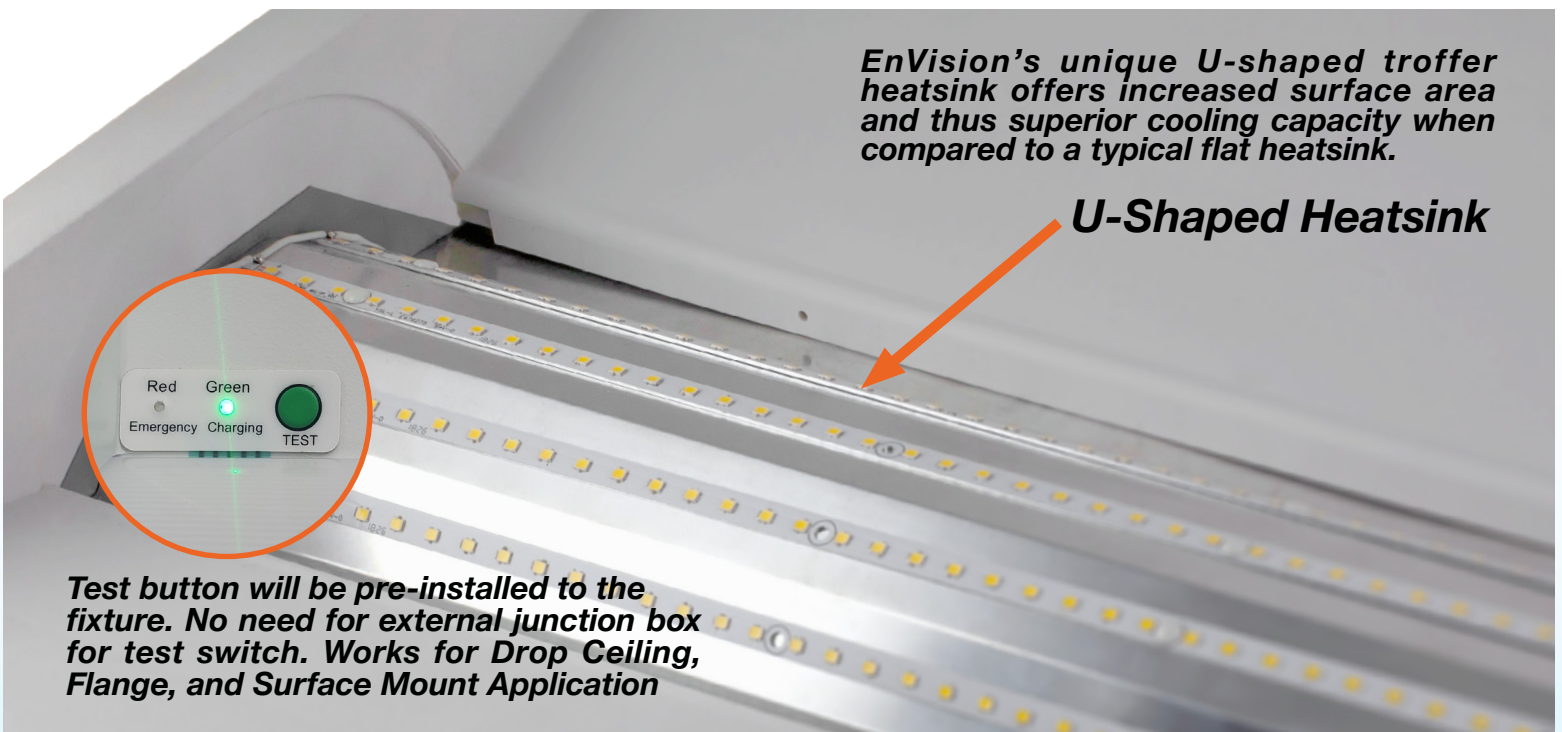

## ACCESSORIES



**EMB**  
Emergency Backup Battery



**BMS**  
Bi-Level Motion Sensor

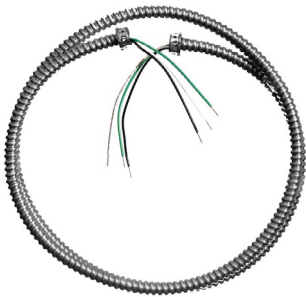

**FLX**  
Flexible Whip

## FIXTURE & ACCESSORY REFERENCE TABLE

Fixture Model	Voltage	Watts	Lumens	Color	CRI
LED-CBT-2X2-28W-50K-HL	120-277V	28w	3,640	5000K	>80
LED-CBT-2X2-28W-40K-HL	120-277V	28w	3,640	4000K	>80
LED-CBT-2X2-28W-35K-HL	120-277V	28w	3,640	3500K	>80
LED-CBT-2X2-35W-50K-HL	120-277V	35w	4,550	5000K	>80
LED-CBT-2X2-35W-40K-HL	120-277V	35w	4,550	4000K	>80
LED-CBT-2X2-35W-35K-HL	120-277V	35w	4,550	3500K	>80
LED-CBT-2X2-PC-CCT-HL	120-277V	20-40	Variable	Variable	>80
LED-CBT-2X4-35W-50K-HL	120-277V	35w	4,550	5000K	>80
LED-CBT-2X4-35W-40K-HL	120-277V	35w	4,550	4000K	>80
LED-CBT-2X4-35W-35K-HL	120-277V	35w	4,550	3500K	>80
LED-CBT-2X4-50W-50K-HL	120-277V	50w	6,500	5000K	>80
LED-CBT-2X4-50W-40K-HL	120-277V	50w	6,500	4000K	>80
LED-CBT-2X4-50W-35K-HL	120-277V	50w	6,500	3500K	>80
LED-CBT-2X4-PC-CCT-HL	120-277V	35-50	Variable	Variable	>80

Accessory Model	Description
LED-EMB-15W-LV	Emergency Backup Battery
2X2-SM-3.5"	2X2 Surface Mount Kit (3.5" Height)
2X4-SM-3.5"	2X4 Surface Mount Kit (3.5" Height)
LED-PNL-2X2-FLNG	2X2 Flange Mount Kit
LED-PNL-2X4-FLNG	2X4 Flange Mount Kit



**2x2**



**2x4**

**Surface Mount Frame**  
(3.5" Height)



**2x2**



**2x4**

**Flange Drywall Kit**



**5000k**

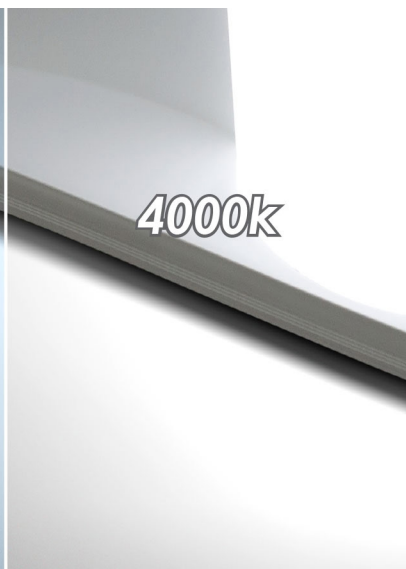

**4000k**



**3500k**

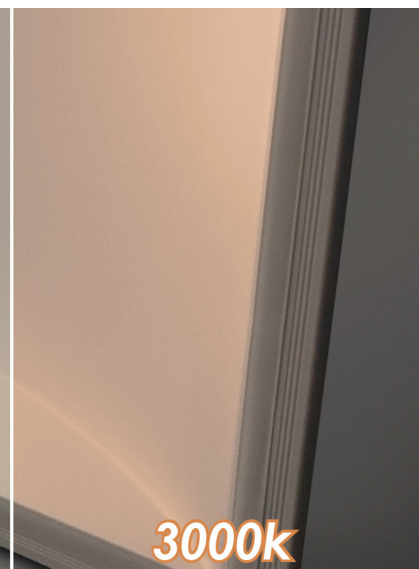

**3000k**

**WIRING DIAGRAM**

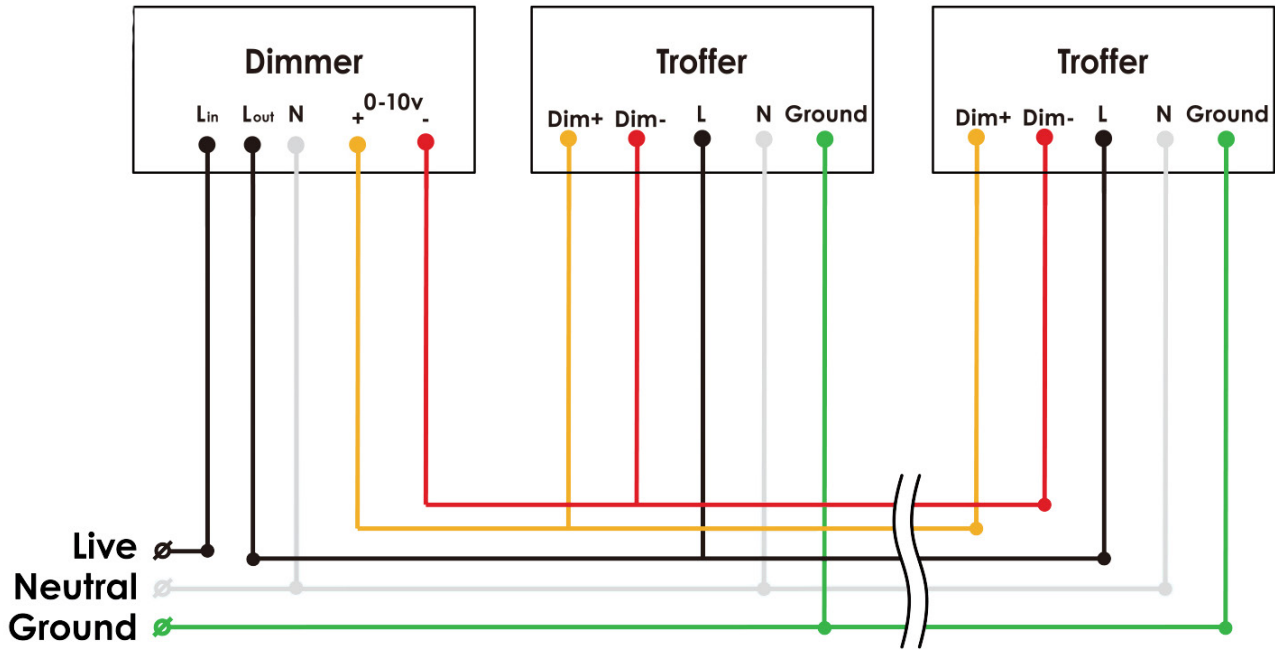

Change color temp. & lighting power (PW-CCT models only)

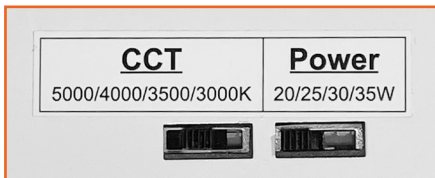

Power & luminosity settings vary by size

