



Large Area Lights Gen 2 3-Power + 3 CCT Selectable

Light up your outdoor area with the new EnVision Bolt Series, our latest line of Area Light fixtures with high lumen per watt efficacy combined with a stunning finish. The EnVision area flood lights are equipped with a die-cast aluminum housing, finished with a matte bronze powder coat paint, and anti-corrosion priming. The Large BOLT series are available in a trunion, yoke, slip fitter, or straight arm mount. Enjoy lighting up your outdoor are with over 140-145lm/w+ efficiency.

Applications:

- General outdoor lighting
- Landscape lighting
- Pathways, streets, loading areas, etc.
- Stadium lighting
- Ideal for exceptional lighting in car dealerships

Detail Specifications:

- Average life (L70) of 70,000 hours with the integration of Philips Lumileds 3030 chips
- Operating temperature -40 ~ 122 F°
- PF >0.9 / Input: .85A/ Output: 36-66V DC
- Built-in 10kv surge protector

Product Information:

- Area Light Gen 1 and Shoebox Fixtures combined into one
- Sturdy die-cast aluminum housing finished with corrosion free powder coat
- Suitable for wet location, professionally waterproofed IP67
- Type III optics standard/ Type I, II, IV, & V by request
- Slim and architectural fixture
- 1.5ft power cable cord provided
- 7 year limited warranty (refer to website for more info)

Certifications:

- UL Listed for USA and CA
- DLC Listed
- CA T24 Compliant

LED - ARL2 - **Watts** - **Color** - **Finish** - **Bracket** - **Voltage** - **Optics** - **Controls**

1 **2** **3** **4** **5** **6** **7** **8**

1 Product	2 Watts	3 Color	4 Finish	5 Bracket	6 Voltage	7 Optics	8 Controls
LED-ARL2 Large Area Light	3P100W 60W 8,700lm 80W 11,600lm 100W 14,500lm	TRI 3000K 4000K 5000K	BZ Bronze* BLK Black WH White GY Grey CS Custom	YK Yoke TR Trunion SF Slip Fitter SA Straight Arm SFA Slip Fitter and Straight Arm	UNV 100-277V HV* 277-480V * only available for the 3P150 and 3P300 model	II Type II III Type III (Standard) IV Type IV V Type V	(Blank) None BMSDL Daylight + Bi-Level Motion Sensor Combo (Internal) PC Photocell 120-277V PCHV Photocell 347-480V
	3P150W 120W 17,400lm 135W 19,575lm 150W 21,750lm						
	3P240W 180W 26,100lm 210W 30,450lm 240W 34,800lm						
	3P300W 260W 37,700lm 280W 40,600lm 300W 43,500lm						

40K Color only available in 150W* Bronze* is in stock. Other colors approx. 7 days Bronze* is a "Quick Ship"

Specs and model numbers are subject to change with or without notice

ACCESSORIES



Yoke

- Flood light bracket
- Ideal use on a wall
- Adjustable design to angle area light luminaire



Trunnion

- Flood light bracket
- Ideal use on a wall
- Can be used for shoebox
- Adjustable design to angle area light luminaire



Straight Arm Adjustable

- Shoebox fixture bracket
- For use with round or square poles
- Can be used for shoebox
- Adjustable design to angle area light luminaire



Slip Fitter

- Shoebox fixture bracket
- For use with round or square poles
- Adjustable design to angle area light luminaire
- Inner diameter of 2.5" to fit 2-2.4" poll

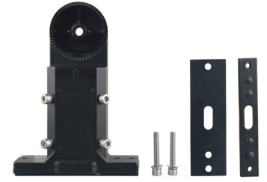

Slip Fitter & Straight Arm

- Flood light bracket
- For use with round or square poles
- Can be used for shoebox
- Adjustable design to angle area light luminaire

ACCESSORIES MODEL

Accessory Model	Accessory Description
LED-ARL-OPTICS-T-II	Type II Optical Lens
LED-ARL-OPTICS-T-IV	Type IV Optical Lens
LED-ARL-OPTICS-T-V	Type V Optical Lens
HB01DMS-A	Bi-Level Motion Sensor + Daylight Harvesting Sensor
HB01DMS-A-CTR	Controller for Sensor
LED-ARL-YK	Yoke Bracket
LED-ARL-TR	Trunnion Bracket
LED-ARL-SF	Slip Fitter Bracket
LED-ARL-SA/ADJ	Straight Arm Adjustable Bracket
LED-ARL-SFA	Slip Fitter and Straight Arm Bracket
SMART-MOD-BT	Bluetooth Control Module
SMART-MOD-BT-GTW	Bluetooth Control Gateway



Controller



3 Pin Photocell 120-277V



3Pin Receptacle



Optic Lenses

- 100 / 150W 1 Pieces Required
- 240 / 300W 2 Pieces Required



HB01DMS-A

- Bi-Level Motion Sensor and Daylight Harvesting Sensor

Mounting Configuration

100-150 EPA RATING

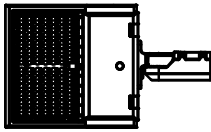

S Single
EPA: 0.55
Weight: 13.2 lbs

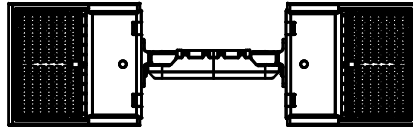

D180 Double 180°
EPA: 1.1
Weight: 26.4 lbs

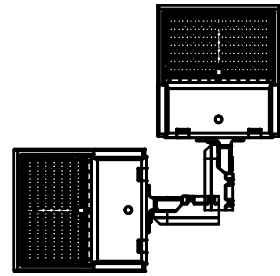

D90 Double 90°
EPA: 0.72
Weight: 26.4 lbs

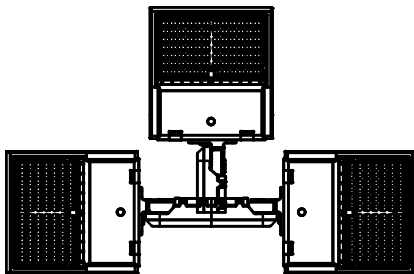

T90 Triple 90°
EPA: 1.1
Weight: 39.6 lbs

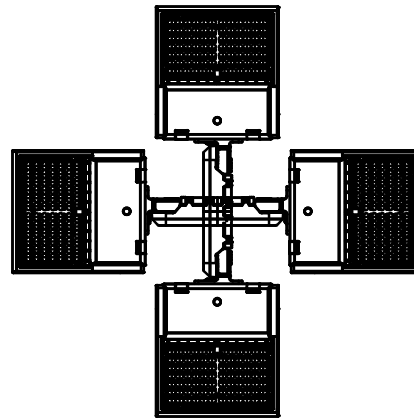

Q90 Quad 90°
EPA: 1.1
Weight: 52.8 lbs

240-300 EPA RATING

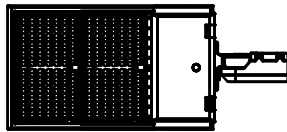

S Single
EPA: 0.75
Weight: 18.2 lbs

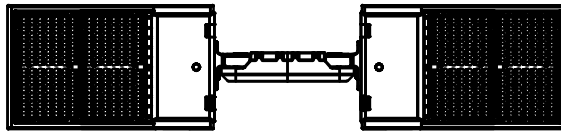

D180 Double 180°
EPA: 1.5
Weight: 36.4 lbs

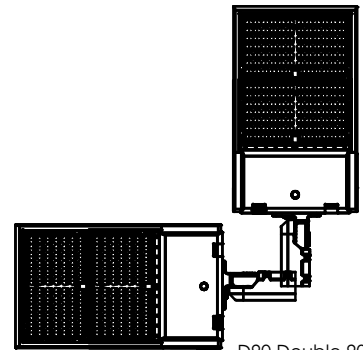

D90 Double 90°
EPA: 0.92
Weight: 36.4 lbs

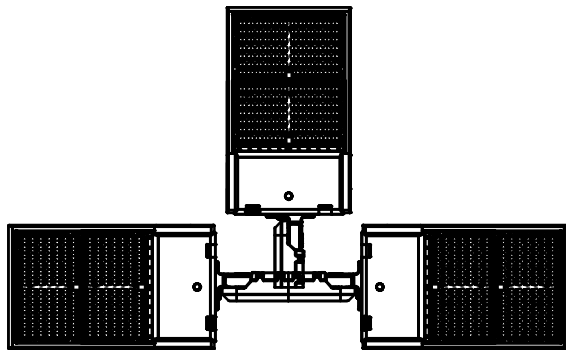

T90 Triple 90°
EPA: 1.5
Weight: 56.4 lbs

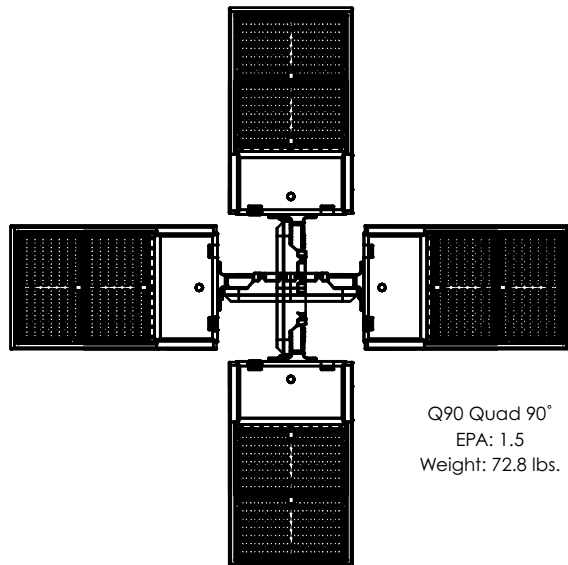

Q90 Quad 90°
EPA: 1.5
Weight: 72.8 lbs.

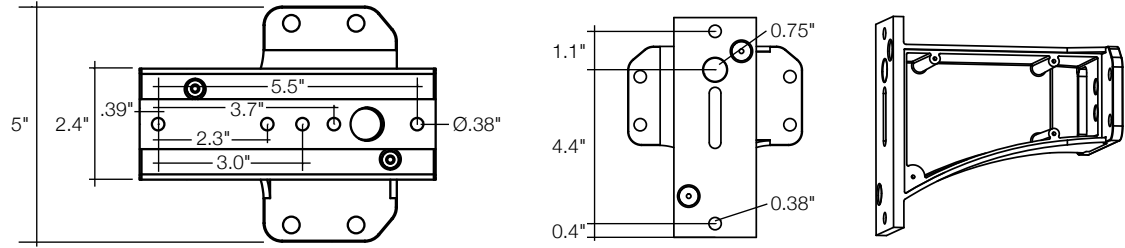

100/150W Dimensions

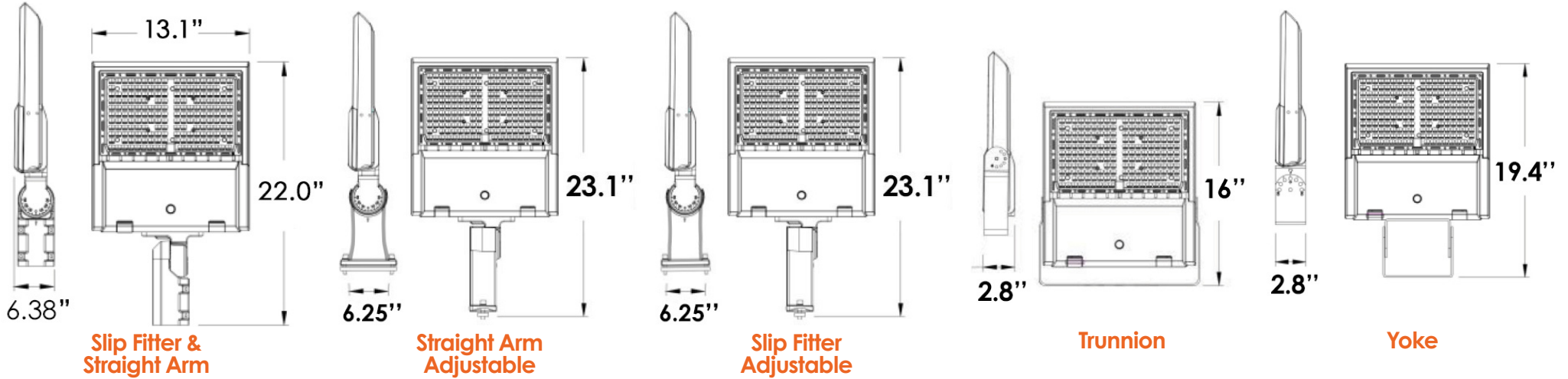

240/300W Dimensions

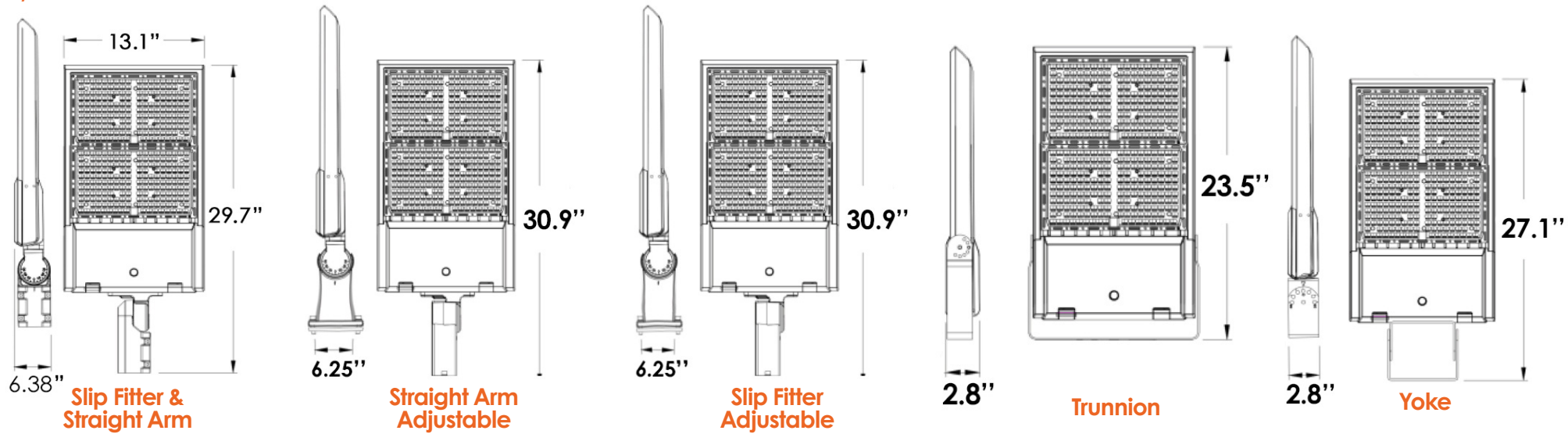

PHOTOMETRICS

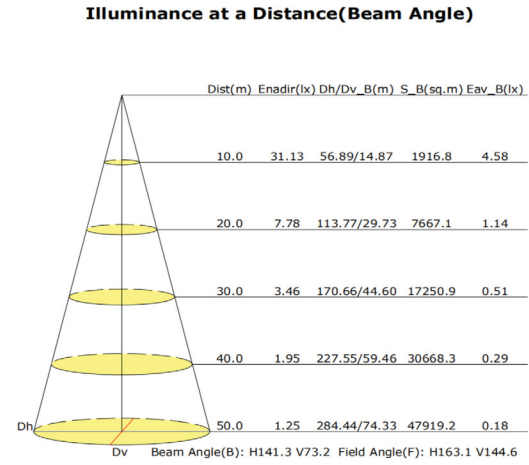
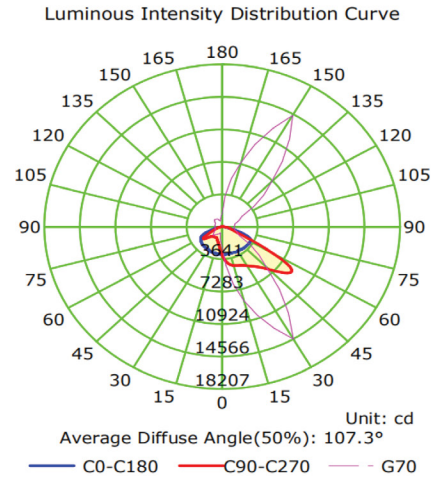

120W

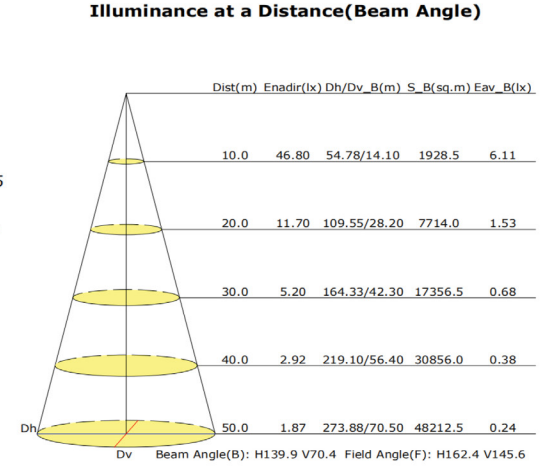
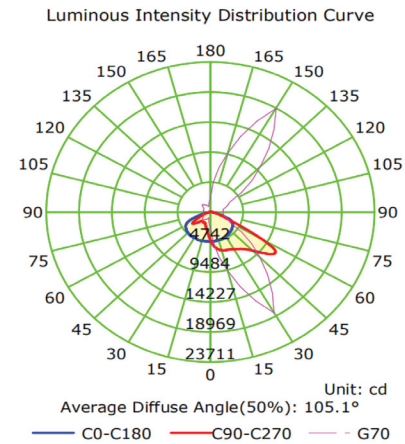

150W & 185W

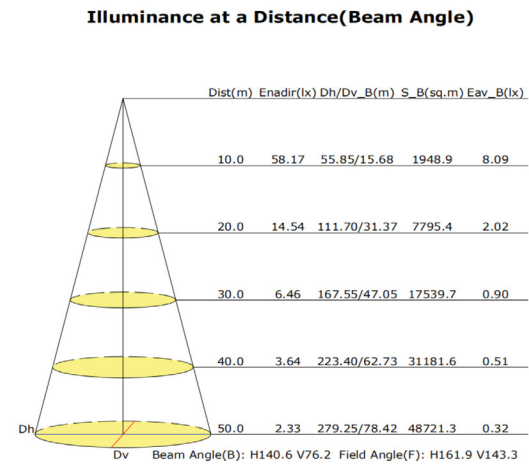
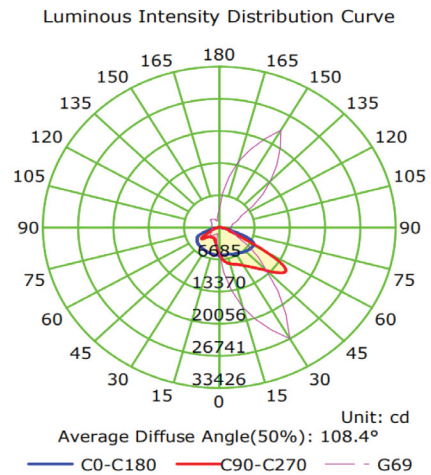

240W

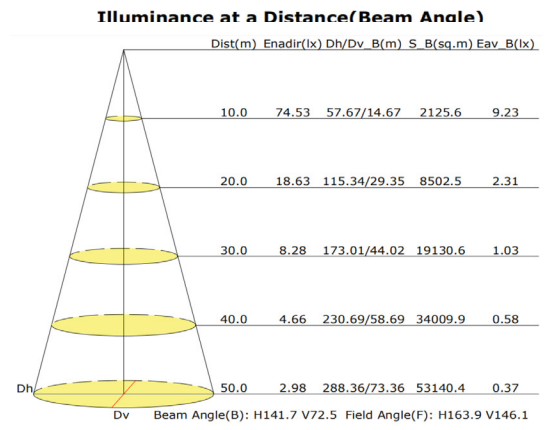
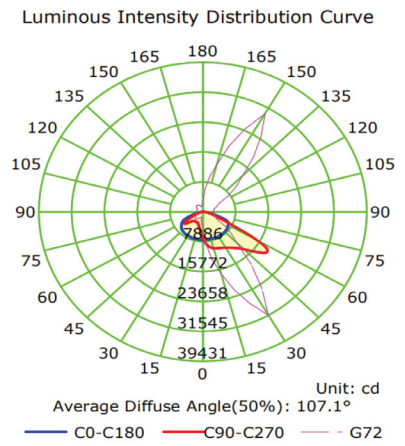

300W