



## Multi-Fire XHD™ 23" Plug-in Electric Firebox

XHD23G

Warm and Stylish with  
Installation Flexibility



The brilliant Multi-Fire® flame effect combined with a range of ambient light themes produce a soothing atmosphere. The XHD Series features intuitive multi-function control options with the added benefit of powerful heating. Create a unique, customizable fireplace that is sure to warm and impress in any space.

Multi-Fire XHD™















## Multi-Fire XHD™ 23" Plug-in Electric Firebox

## XHD23G



Built-in display and touch controls

### Features

-  **Multi-Fire XHD™ Flame Effect**  
High-contrast flames feature improved brightness and character for a dazzling, lifelike effect.
-  **Acrylic Ice Media Bed**  
Light plays through different size pieces and sparkle in a spectrum of colors.
-  **Customizable Flame**  
Adjust the flame speed and brightness to create the perfect atmosphere to suit your mood or room.
-  **Capacitive Touch Controls**  
Settings and temperature display are hidden when not in use.
-  **Media Accent Colors**  
Choose from a variety of brilliant color themes or cycle through a range of colors using the custom mode, freezing on the hue of your choice.
-  **Built-in Timer**  
Can be set to automatically turn the unit off after a maximum of 8 hours.
-  **LED Lighting**  
Flame and lights use brilliant, low-energy LED's that require zero maintenance.
-  **Powerful Heating**  
Powerful fan-forced heater provides on-demand heat for up to 1,000 sq. ft. Disable option is ideal where heat is not wanted or needed.
-  **Multi-function Remote**  
Control the fireplace features from the comfort of your chair.
-  **All-season Flames**  
Enjoy the unique charm of a fireplace 365 days a year using the flames without the heat.
-  **Economical**  
Economical to operate costing only pennies per hour.\*
-  **Low Carbon Footprint**  
The most sustainable fireplace option; no emissions and 100% efficient.
-  **Cool-touch Glass**  
Glass remains cool making it safe for children and pets.
-  **Just Plug It In**  
Simply plug into any standard household outlet for instant ambiance.



Also available with Realogs®: XHD23L

### Color Themes



Multi-function Remote

120 Volts | 1,465 Watts | 5,000 BTU

Model #	Description	Lbs / Kg (packaged)	UPC	Wty. <sup>1</sup>	Carton Dimensions (WxHxD)		Cube	
					Inches	cm	ft <sup>3</sup>	m <sup>3</sup>
XHD23G	23" Multi-Fire XHD Electric Firebox - Acrylic Ice	23 / 10.4 (29.1 / 13.2)	781052 115118	2 yr.	25-5/8 x 24 x 10-5/8	65.0 x 61.0 x 27.0	4.0	0.1
XHD23L	23" Multi-Fire XHD Electric Firebox - Realogs	23 / 10.4 (28.2 / 12.8)	781052 115125	2 yr.	25-5/8 x 24 x 10-5/8	65.0 x 61.0 x 27.0	4.0	0.1

Specifications, finishes and dimensions are subject to change. <sup>1</sup>Limited warranty. ©2022 Glen Dimplex Americas

\* Based on national average residential electricity rate. Rates vary.

SE-376-R07-040422

## Multi-Fire XHD™ 23" Plug-in Electric Firebox

### XHD23G

### Product Dimensions:

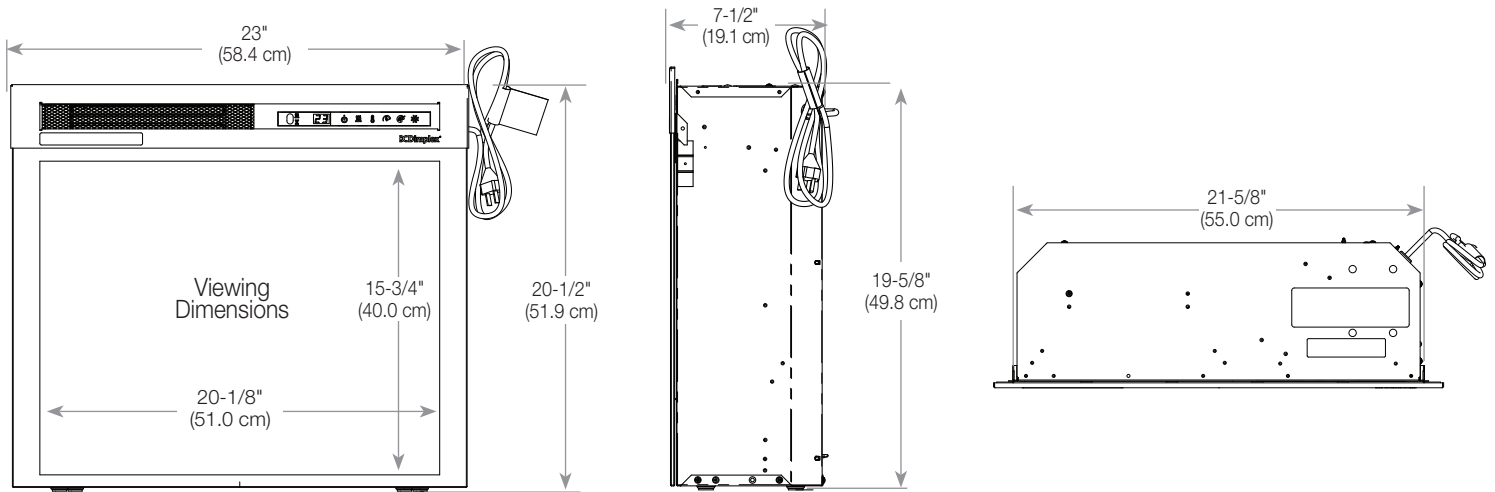

### Framing Dimensions:

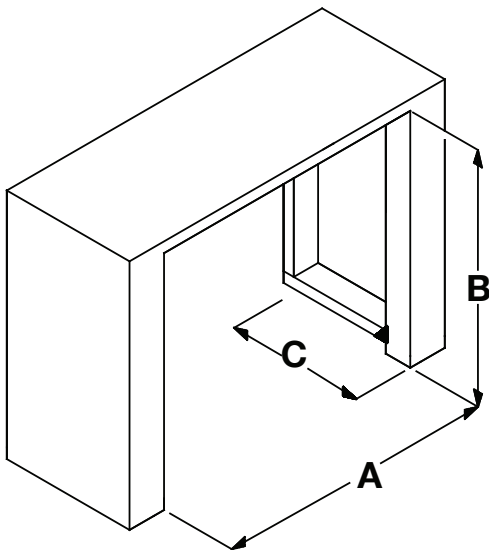

#### XHD23G

A	B	C
21-1/2" (54.8)	20" (50.8 cm)	8" (20.3 cm)

**NOTE:** The XHD23G Electric Firebox does not require any special venting. Make sure there is clearance for air circulation beneath the unit and at least 1/2" behind it.