



Item # _____

Project _____



Recessed Canopy



Surface Mount Canopy

	DI-VL-CP100W	DI-VL-CP200W
Voltage	120V-277VAC	
Wattage	100w	200w
Lumens¹	14,300	26,800
LED Chip Beam Angle*	Narrow Beam, Medium Beam, Wide Beam, Type 1, Type 2, Type 3, Type 4, Type 5	
Efficacy²	~143 lm/w	~134 lm/w
Dimensions	See Mechanical Diagrams	
Color Temperature	4000K, 5000K	
CRI	80+	
Dimmable	No	
Environment^{3**}	Indoor / Outdoor / IP65	
Certification	ETL Listed	
Warranty	5-Year Warranty	

* See Light Distribution Lens Options on page 3 for more information

**WARNING: NOT FOR USE IN SUBMERSIBLE APPLICATIONS

SKU Builder

DI

-

VL

Model
Wattage
Color Temp
Mount

Lens Type

CP100W	40	R	NB	T2
CP200W	50	S	MB	T3
			WB	T4
			T1	T5

Example: DI-VL-CP200W-50-S-T3 = Diode, VOLANTE[®] Canopy Light, 200W, 5,000° CCT, Surface Mount, Type 3 Lens

SPECIFICATIONS CONTINUED

- LED Chip: 80 per module
- Connections⁴: Hardwire
- Ambient Temp⁵: -40- 113°F (-40- 45°C)

COMPLIANCE & REGULATORY APPROVALS

Safety

- ETL Listed

MECHANICAL DIAGRAMS

RECESSED CANOPY*

DI-VL-CP100W-40-R DI-VL-CP200W-40-R
 DI-VL-CP100W-50-R DI-VL-CP200W-50-R

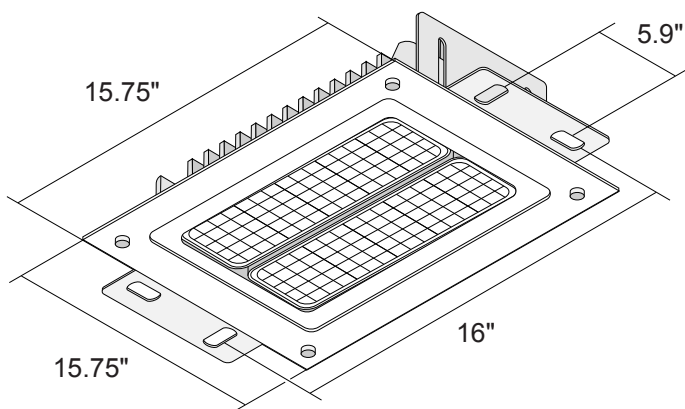

**Note: Above listed measurements are the same for 2 module, and 3 module fixtures.*

SURFACE MOUNT CANOPY*

DI-VL-CP100W-40-S DI-VL-CP200W-40-S
 DI-VL-CP100W-50-S DI-VL-CP200W-50-S

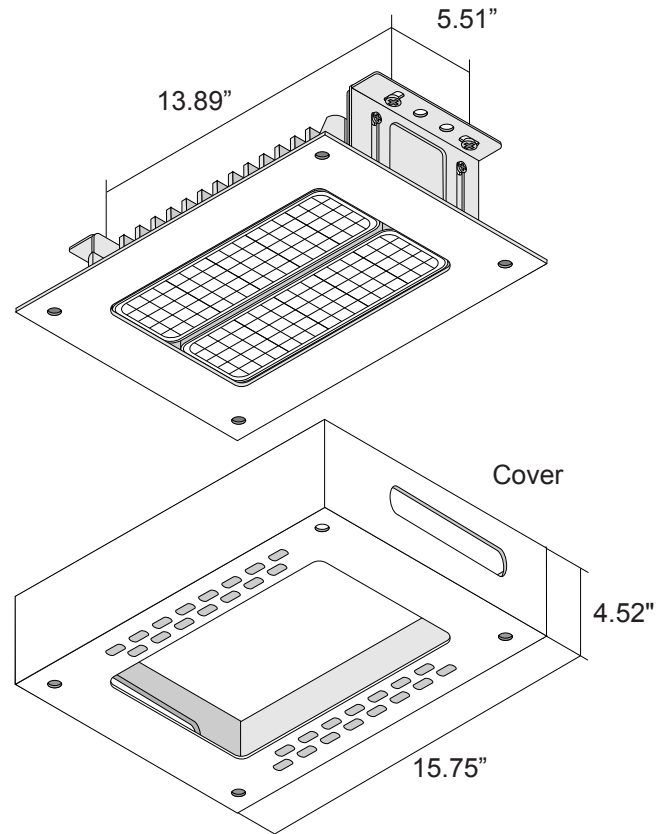

**Note: Above listed measurements are the same for 2 module, and 3 module fixtures.*

1. LED chips have a luminous flux range with a tolerance of +/- 5%.
2. Estimated efficacy value can be calculated as follows: Lumen value divided by average power consumption per foot.
3. Do not install in environment where LED chips are exposed to direct sunlight as damage to the phosphor will occur. NEC definition of damp location: Locations protected from weather and not subject to saturation with water or other liquids but subject to moderate degrees of moisture. Examples of such locations include partially protected areas under canopies, marquees, roofed open porches, and like locations. Interior locations subject to moderate degrees of moisture are also acceptable, such as some basements, some barns, and some cold-storage warehouses.
4. Wire leads and accessories are not rated for in-wall installation unless otherwise noted. Attached wire leads and connections are field-cutttable.
5. Do not install product in an environment that exceeds the maximum ambient temperature. Exceeding the maximum ambient temperature may damage LED chips, reduce the total lamp life, lumen output, and/or adversely impact color consistency.

LIGHT DISTRIBUTION LENS OPTIONS

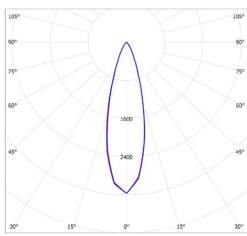

**30° x 30°
Narrow Beam (NB)**
Spotlight or concentrated applications

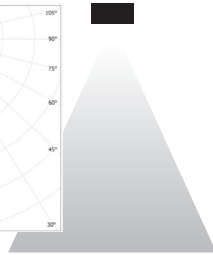
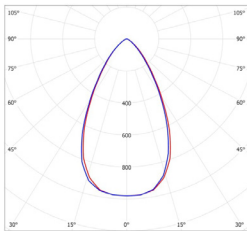

**60° x 60°
Medium Beam (MB)**
Directional floodlight for general lighting

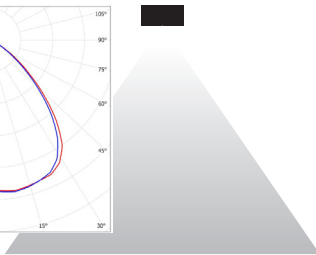
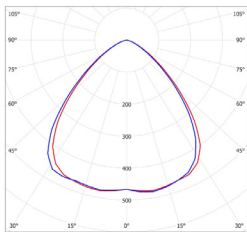

**90° x 90°
Wide Beam (WB)**
Wide floodlight for general lighting

**30° x 100°
Type I (1)**
Paths, walkways and sidewalks
(Intended for center area mounting)

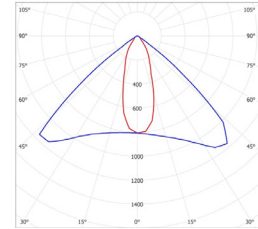

**50° x 140°
Type II (2)**
Wide-walkways, roadway entrances, and
mass access points.
(Intended for pole or wall mounting)

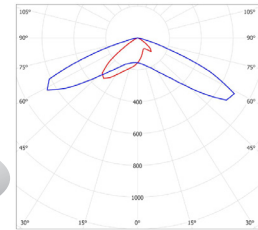
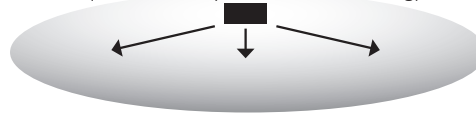

**40° x 140°
Type III (3)**
General parking areas, roadway, and area lighting
(Intended for pole or wall mounting)

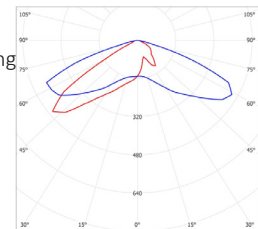
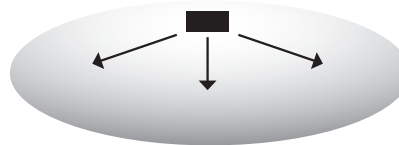

**30° x 140°
Type IV (4)**
Perimeter parking and business area lighting
(Intended for pole or wall mounting)

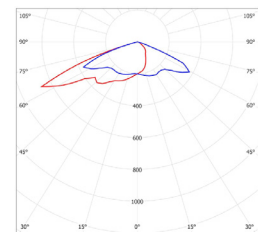
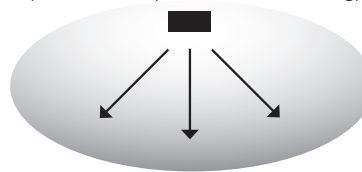

**140° x 140°
Type V (5)**
Center area lighting for roadways or commercial
parking lot lighting
(Intended for top center area mounting)

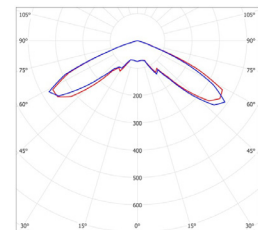
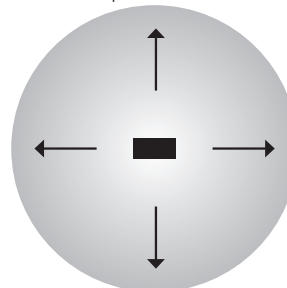

ADDITIONAL INFORMATION

- VOLANTE® LED Canopy Light Installation Guide

SAFETY / WARNINGS / DISCLOSURES

1. Install in accordance with national and local electrical code regulations.
2. This product is intended to be installed and serviced by a qualified, licensed electrician.
3. Only use copper wiring. Use wires rated for at least 176°F (80°C) and certified for use with external connection of electrical equipment.
4. Ensure applicable wire is installed between fixture, and any controls in-between. When choosing wire, factor in voltage drop, amperage rating, and type (in-wall rated, wet location rated, etc.). Inadequate wire installation could overheat wires, and cause fire.
5. Do not install in environment where LED chips are exposed to direct sunlight as damage to the phosphor will occur.
6. Do not install in environment where excessive heat may exist (ex. close proximity to fireplace, etc.) See Ambient Temperature ratings
7. Do not modify product beyond instructions or warranty will be void.
8. Actual color may vary from what is pictured on this sheet and other print materials due to the limitations of photographic processes.
9. We reserve the right to modify and improve the design of our fixtures without prior notice. We cannot guarantee to match existing installed fixtures for subsequent orders or replacements in regards to product appearance, CCT, or lumen output.

WARRANTY

Limited Warranty

This product has a five (5) year limited warranty from the date of shipment. This warranty does not include the additional accessories referenced in this specification sheet. Complete warranty details for fixtures and additional accessories are available at www.diodeled.com/limited-warranty/ within the Policies section. For warranty related questions please contact product support.

Consumer's Acknowledgment

Elemental LED, Inc. stands behind its products when they are used properly and according to our specifications. By purchasing our products, the purchaser agrees and acknowledges that lighting design, configuration and installation is a complex process, wherein seemingly minor factors or changes in layout and infield adjustments can have a significant impact on an entire system. Choosing the correct components is essential. Elemental LED is able to work with the original purchaser to make an appropriate product selection to the extent of the limited information that the customer can provide, but it is virtually impossible for Elemental LED to design a system that foresees every unknown factor. For this reason, this Warranty does not cover problems caused by improper design, configuration or installation issues. Any statement from an Elemental LED employee or agent regarding a customer's bill of goods and/or purchase order is NOT an acknowledgment that the products purchased are designed and configured correctly. The purchaser agrees and acknowledges that it is the customer's responsibility to adhere strictly to all information contained in the Product Specification Sheets.

There is often more than one way to design, configure and layout an LED lighting application properly to achieve the same lighting effect. Elemental LED strongly recommends that licensed professionals be used in the design and installation of lighting systems that include Elemental LED products. The specifications include important information that a designer and installer should carefully review and strictly follow. Qualified designers and certified and/or licensed installers, with access to the final installation environment, customer goals, and Elemental LED product specifications can make the requisite decisions appropriate for a successful finished lighting application.

