

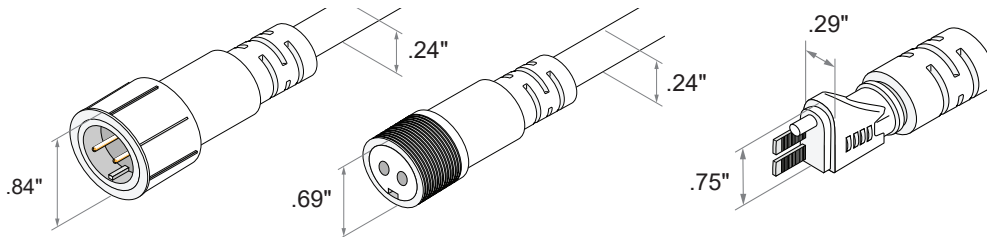

Item #

Project

NEON BLAZE™ Connectors



SIDE BENDING ACCESSORIES

NEON BLAZE™ Side bending

Straight wire entry connector

DI-SE-NB-STWC-EC

(16 AWG)

NEON BLAZE™ Opaque and frosted Side bending Straight wire entry connector covers included.

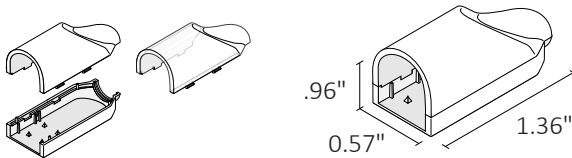
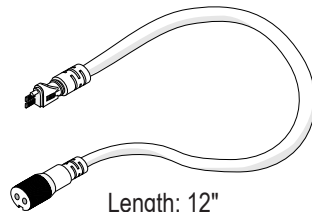

NEON BLAZE™ Side bending

Bottom wire entry connector

DI-SE-NB-BWC-EC

(16 AWG)

NEON BLAZE™ Opaque and frosted Side bending Bottom wire entry connector covers included.

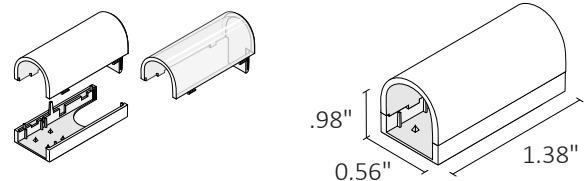
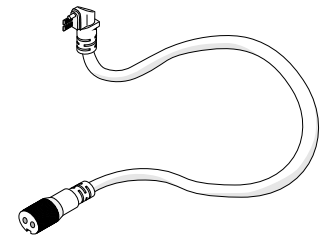

NEON BLAZE™ Side bending

Side wire entry connector

DI-SE-NB-SDWC-EC

(16 AWG)

NEON BLAZE™ Opaque and frosted Side bending Side wire entry connector covers included.

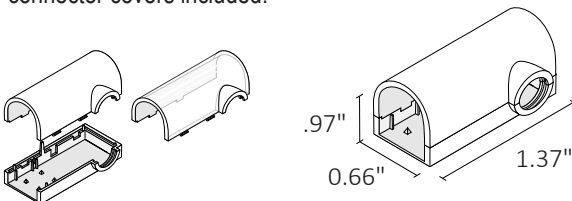
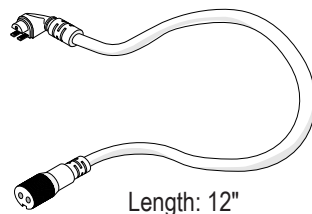

NEON BLAZE™ Side bending

Straight wire entry connector

DI-SE-NB-STBW-20

(16 AWG)

NEON BLAZE™ Opaque and frosted Side bending Straight wire entry connector covers **not included**.

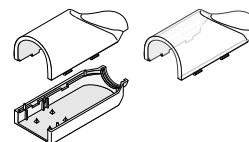
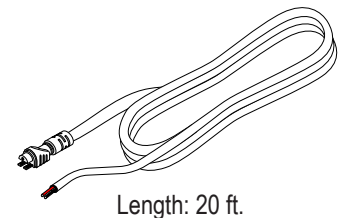

NEON BLAZE™ 24V LED ACCESSORIES

SPECIFICATION SHEET

SIDE BENDING ACCESSORIES

NEON BLAZE™ Side bending Strip to Strip Frosted Connector
DI-SE-NB-TTT-2

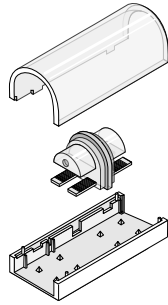
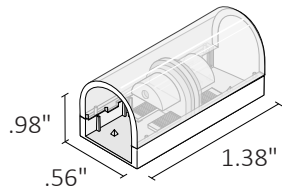

NEON BLAZE™ Side bending Jumper with Frosted Top Cap and End Cap
DI-SE-NB-3JPR
DI-SE-NB-6JPR
DI-SE-NB-12JPR
DI-SE-NB-24JPR
(16 AWG)

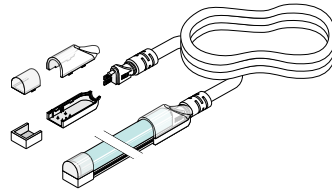

Jumper length: 3", 6", 12", & 24"

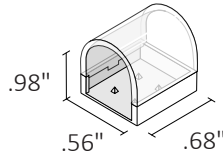
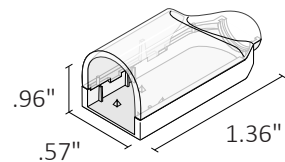

NEON BLAZE™ Side bending Straight wire entry with Frosted DC Barrel Plug
DI-SE-NB-SDWC-EC-FDC
(16 AWG)

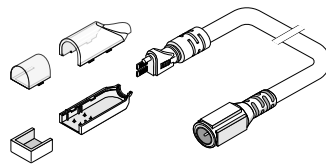

Cable length: 12"

NEON BLAZE™ Opaque and frosted Side bending Straight wire entry connector not covers included.

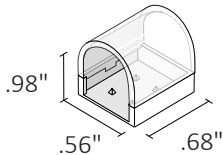
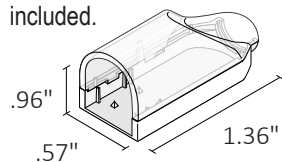

NEON BLAZE™ Side bending End Cap
(Included with all Connectors)

DI-SE-NB-EC-5

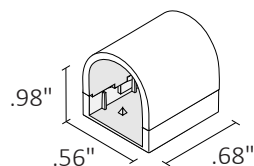

NEON BLAZE™ 96" Male Connector
DI-NB-96M-CNCT
(16 AWG)

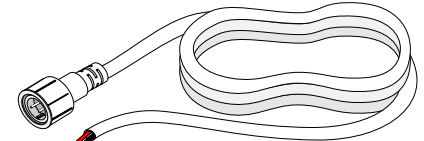

Length: 96"

NEON BLAZE™ Side bending Bottom U-Clip
DI-SE-NB-BUC-16

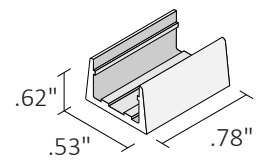

NEON BLAZE™ Side bending Top U-Clip
DI-SE-NB-TUC-16

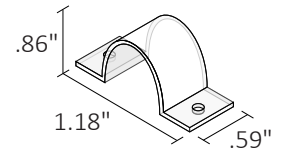

NEON BLAZE™ Side Bending Channel

Material: Anodized Aluminum

DI-SE-NB-MTCH

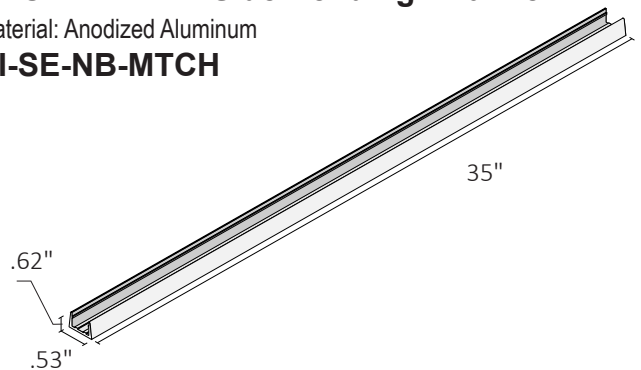

NEON BLAZE™ Side bending Flexible Channel
DI-SE-NB-FLCH-WH

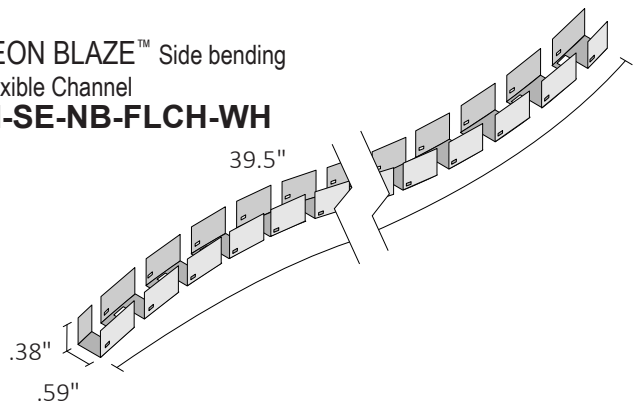

NEON BLAZE™ 24V LED ACCESSORIES

SPECIFICATION SHEET

ADDITIONAL INFORMATION

- NEON BLAZE™ 24V LED STRIP LIGHT Installation Guide

SAFETY / WARNINGS / DISCLOSURES

1. Install in accordance with national and local electrical code regulations.
2. This product is intended to be installed and serviced by a qualified, licensed electrician.
3. Only install with a listed Class 2 DC LED Driver.
4. Not for use in or on walls of pools, fountains, or other partially or fully submersed locations.
5. Do not modify or disassemble product beyond instructions or this warranty will be void.
6. Actual color may vary from what is pictured above and on other print materials due to the limitations of photographic processes.
7. We reserve the right to modify and improve the design of our fixtures without prior notice. We cannot guarantee to match existing installed fixtures for subsequent orders or replacements in regards to product appearance, CCT, or lumen output.

SPECIFICATIONS

- Input: 24VDC Constant Voltage
- Material: UV/IR resistant silicone
- Ambient Temp¹: -4 - 122°F (-20 ~ 50°C)
- Operating Temp²: -4 - 176°F (-20 ~ 80°C)
- Flammability³: Flame retardant

COMPLIANCE & REGULATORY APPROVALS

Safety

- UL Listed 2108 Low Voltage Lighting Systems. Certified for United States and Canada. File # E469769.

1. Do not install product in an environment outside the listed ambient temperature. Exceeding the maximum ambient temperature may damage LED chips, reduce the total lamp life, lumen output, and/or adversely impact color consistency.
2. Operating temperature is measured according to the minimum and maximum ambient temperature environment.
3. This product has been tested and passed glow-wire flammability tests (GWFI index) at 650°C/1200°F, providing an extra level of safety for common areas, hospitality, and areas of high risk fire.

WARRANTY

Limited Warranty

This product has a five (5) year limited warranty from the date of shipment. This warranty does not include the additional accessories referenced in this specification sheet. Complete warranty details for fixtures and additional accessories are available at www.diodeled.com/limited-warranty/ within the Policies section. For warranty related questions please contact product support.

Consumer's Acknowledgment

Elemental LED, Inc. stands behind its products when they are used properly and according to our specifications. By purchasing our products, the purchaser agrees and acknowledges that lighting design, configuration and installation is a complex process, wherein seemingly minor factors or changes in layout and infield adjustments can have a significant impact on an entire system. Choosing the correct components is essential. Elemental LED is able to work with the original purchaser to make an appropriate product selection to the extent of the limited information that the customer can provide, but it is virtually impossible for Elemental LED to design a system that foresees every unknown factor. For this reason, this Warranty does not cover problems caused by improper design, configuration or installation issues. Any statement from an Elemental LED employee or agent regarding a customer's bill of goods and/or purchase order is NOT an acknowledgment that the products purchased are designed and configured correctly. The purchaser agrees and acknowledges that it is the customer's responsibility to adhere strictly to all information contained in the Product Specification Sheets.

There is often more than one way to design, configure and layout an LED lighting application properly to achieve the same lighting effect. Elemental LED strongly recommends that licensed professionals be used in the design and installation of lighting systems that include Elemental LED products. The specifications include important information that a designer and installer should carefully review and strictly follow. Qualified designers and certified and/or licensed installers, with access to the final installation environment, customer goals, and Elemental LED product specifications can make the requisite decisions appropriate for a successful finished lighting application.



© 2021 Elemental LED, Inc. All rights reserved.

Specifications are subject to change without notice.

Toll Free: 877.817.6028 | Fax: 415.592.1596 | www.DiodeLED.com | info@DiodeLED.com

SPEC SHEET | NEON BLAZE™ 24V LED STRIP LIGHT | SS052121-10.0 | 3 OF 3