

# 24VDC PLUG-IN ADAPTER

# SPECIFICATION SHEET



## OVERVIEW



24VDC Plug-in Adapters convert 120VAC voltage to 24VDC output. An adapter is the right choice for portable installations where hard-wiring is not desired. These adapters may be paired with low voltage In-Line Switches, Dimmers and RGB(W)/DMX Controls. These adapters are available in multiple form factors and voltage/wattage combinations to meet your low-voltage LED lighting needs.

## FEATURES

- Available in wattages 12W to 96W
- Available in white and black finishes
- Short circuit, over current, over voltage, over temperature protections
- Fanless design / cooling by free-air convection
- UL Listed 1310 Class 2 models available

Item #	
Project	

## SPECIFICATIONS - 24VDC Output Models

	DI-PA-24V12W-CL2-B (Black) DI-PA-24V12W-CL2-W (White)	DI-PA-24V24W-CL2-B (Black) DI-PA-24V24W-CL2-W (White)	DI-PA-24V48W-CL2-B (Black) DI-PA-24V48W-CL2-W (White)
			
<b>Input Voltage / Frequency</b>	100 ~ 240VAC / 50 ~ 60Hz	100 ~ 240VAC / 50 ~ 60Hz	100 ~ 240VAC / 50 ~ 60Hz
<b>Max Load<sup>1</sup></b>	12W / 0.5A	24W / 1.0A	48W / 2.0A
<b>Class 2 Certified</b>	Yes	Yes	Yes
<b>Output Voltage</b>	24VDC	24VDC	24VDC
<b>Ambient Temperature<sup>2</sup></b>	+32 ~ +104°F (0 ~ +40°C)	+32 ~ +104°F (0 ~ +40°C)	+32 ~ +104°F (0 ~ +40°C)
<b>Operating Temperature<sup>3</sup></b>	+32 ~ +130°F (0 ~ +52°C)	+32 ~ +130°F (0 ~ +52°C)	+32 ~ +130°F (0 ~ +52°C)
<b>Minimum Load</b>	None	None	None
<b>Dimmability<sup>4</sup></b>	Yes. PWM & RGB(W) dimmers/controls & DMX controls	Yes. PWM & RGB(W) dimmers/controls & DMX controls	Yes. PWM & RGB(W) dimmers/controls & DMX controls
<b>Input Current Full Load</b>	0.35A@115VAC	1.2A@115VAC	1.5A@115VAC
<b>Primary Connection</b>	Wall Plug Type: 2 Prong NEMA 1-15p Male AC Plug	Wall Plug Type: 2 Prong NEMA 1-15p Male AC Plug	Desktop Plug Type: 2 Prong NEMA 1-15p Male AC Plug
<b>Secondary Leads</b>	Male DC 5.5 x 2.1mm coaxial (outside dia. x inside dia.)	Male DC 5.5 x 2.1mm coaxial (outside dia. x inside dia.)	Male DC 5.5 x 2.1mm coaxial (outside dia. x inside dia.)
<b>Voltage Boost</b>	No	No	No
<b>Circuit Breakers</b>	Auto Reset Hiccup	Auto Reset Hiccup	Auto Reset Hiccup
<b>Environment</b>	Indoor / Dry Location	Indoor / Dry Location	Indoor / Dry Location
<b>Working Humidity</b>	20 ~ 90% RH non-condensing	20 ~ 90% RH non-condensing	20 ~ 90% RH non-condensing
<b>Housing / Cooling</b>	Plastic Class II power unit, no FG connection / free air convection	Plastic Class II power unit, no FG connection / free air convection	Plastic Class II power unit, no FG connection / free air convection
<b>Dimensions</b>	2.35 x 1.75 x 1.40 in. (L x W x H)	3.80 x 1.75 x 1.40 in. (L x W x H)	4.70 x 2.00 x 1.25 in. (L x W x H)
<b>Weight</b>	0.187 lbs (3.0 oz.)	0.5 lbs. (8 oz.)	0.625 lbs (10 oz.)
<b>Warranty</b>	1 Year	1 Year	1 Year
<b>Certifications</b>	All Models: cULus Listed 1310 Class 2 Power Supply. Level VI Efficiency.	All Models: cULus Listed 1310 Class 2 Power Supply. Level VI Efficiency.	All Models: cULus Listed 1310 Class 2 Power Supply. Level VI Efficiency.

1. It is recommended to derate the plug-in adapter to 80% of the full labeled load for maximum longevity.

2. Do not install product in an environment outside the listed ambient temperature.

3. Operating temperature is measured according to the minimum and maximum ambient temperature environment.

4. Not compatible with 120VAC dimming controls. PWM dimmer/control spec sheet will indicate if multiple controls can be paired to a single adapter.

## SPECIFICATIONS CONT. - 24VDC Output Models

	DI-PA-24V96W-CL2-B (Black) DI-PA-24V96W-CL2-W (White)
	
<b>Input Voltage / Frequency</b>	100 ~ 240VAC / 50 ~ 60Hz
<b>Max Load<sup>1</sup></b>	96W / 4.0A
<b>Class 2 Certified</b>	Yes
<b>Output Voltage</b>	24VDC
<b>Ambient Temperature<sup>2</sup></b>	+32 ~ +104°F (0 ~ +40°C)
<b>Operating Temperature<sup>3</sup></b>	+32 ~ +130°F (0 ~ +52°C)
<b>Minimum Load</b>	None
<b>Dimmability<sup>4</sup></b>	Yes. PWM & RGB(W) dimmers/controls & DMX controls
<b>Input Current Full Load</b>	2.0A@115VAC
<b>Primary Connection</b>	Desktop Plug Type: 2 Prong NEMA 1-15p Male AC Plu
<b>Secondary Leads</b>	Male DC 5.5 x 2.1mm coaxial (outside dia. x inside dia.)
<b>Voltage Boost</b>	No
<b>Circuit Breakers</b>	Auto Reset Hiccup
<b>Environment</b>	Indoor / Dry Location
<b>Working Humidity</b>	20 ~ 90% RH non-condensing
<b>Housing / Cooling</b>	Plastic Class II power unit, no FG connection / free air convection
<b>Dimensions</b>	4.70 x 2.00 x 1.25 in. (L x W x H)
<b>Weight</b>	0.625 lbs (10 oz.)
<b>Warranty</b>	1 Year
<b>Certifications</b>	All Models: cULus Listed 1310 Class 2 Power Supply. Level VI Efficiency.









1. It is recommended to derate the plug-in adapter to 80% of the full labeled load for maximum longevity.

2. Do not install product in an environment outside the listed ambient temperature.

3. Operating temperature is measured according to the minimum and maximum ambient temperature environment.





4. Not compatible with 120VAC dimming controls. PWM dimmer/control spec sheet will indicate if multiple controls can be paired to a single adapter.

## 12-24VDC PLUG ACCESSORIES

Item #	Finish	QTY	Max Load	Product Description	
DI-PVC2464-DL42-SPL-F-**	WH <input type="checkbox"/>	5 or 25 Pack	All Models 12V: 60W 24V: 100W	ADAPTER SPLICE CABLE- FEMALE Converts a Male DC Plug to a hard-wired connection. Wire: 18/2 AWG. Dimensions: 42 x 0.45 in. (L x Dia)	
DI-PVC2464-DL42-SPL-M-**	WH <input type="checkbox"/>	5 or 25 Pack	All Models 12V: 60W 24V: 100W	ADAPTER SPLICE CABLE- MALE Converts a Female DC Plug to a hard-wired connection. Wire: 18/2 AWG. Dimensions: 42 x 0.45 in. (L x Dia)	
DI-0708-** DI-0708B-**	WH <input type="checkbox"/> BK <input checked="" type="checkbox"/>	5 or 25 Pack	All Models 12V: 60W 24V: 100W	39 IN. DC EXTENSION CABLE Creates extension between accessory featuring DC Plugs. Wire: 18/2 AWG. Dimensions: 39.4 x 0.45 in. (L x Dia)	
DI-0720-** DI-0720B-**	WH <input type="checkbox"/> BK <input checked="" type="checkbox"/>	5 or 25 Pack	All Models 12V: 60W 24V: 100W	2-WAY DC SPLITTER Splits power from a plug-in adapter to 2x Male DC Plugs. Wire: 22/2 AWG. Dimensions: 8.0 x 0.45 in. (L x Dia)	
DI-0705-** DI-0705B-**	WH <input type="checkbox"/> BK <input checked="" type="checkbox"/>	5 or 25 Pack	All Models 12V: 60W 24V: 100W	3-WAY DC SPLITTER Splits power from a plug-in adapter to 3x Male DC Plugs. Wire: 22/2 AWG. Dimensions: 8.0 x 0.60 in. (L x Dia)	
DI-DCSP4-**	WH <input type="checkbox"/>	5 or 25 Pack	All Models 12V: 60W 24V: 100W	4-WAY DC SPLITTER Splits power from a plug-in adapter to 4x Male DC Plugs. Wire: 22/2 AWG. Dimensions: 8.0 x 0.60 in. (L x Dia)	
DI-0707-** DI-0707B-**	WH <input type="checkbox"/> BK <input checked="" type="checkbox"/>	5 or 25 Pack	All Models 12V: 60W 24V: 100W	5-WAY DC SPLITTER Splits power from a plug-in adapter to 5x Male DC Plugs. Wire: 22/2 AWG. Dimensions: 8.0 x 0.60 in. (L x Dia)	
DI-0710F-** (Female) DI-0710M-** (Male)	BK <input checked="" type="checkbox"/>	5 or 25 Pack	All Models 12V: 60W 24V: 100W	9MM WET LOCATION TO DC ADAPTER CONNECTOR Attaches wet location fixtures featuring 9mm wet location plugs to a standard DC Plug-in Adapter. Wire: 22/2 AWG. Dimensions: 6.0 x 0.4 in. (L x Dia)	
DI-10MM-WL-DC-F-** (Female) DI-10MM-WL-DC-M-** (Male)	WH <input type="checkbox"/>	5 or 25 Pack	All Models 12V: 60W 24V: 100W	10MM WET LOCATION TO DC ADAPTER CONNECTOR Attaches wet location tape lights featuring 10mm wet location plugs to a standard DC Plug-in Adapter. Wire: 22/2 AWG. Dimensions: 6.0 x 0.4 in. (L x Dia)	

\*\* - Add a -5 for 5 Pack or -25 for 25 Pack

## 12-24VDC INLINE SWITCHES & DIMMERS

Item #	Finish	QTY	Max Load	Product Description	
DI-0714 DI-0714B	WH <input type="checkbox"/> BK <input checked="" type="checkbox"/>	Single	All Models 12V: 24W 24V: 48W	INLINE LED ON/OFF SWITCH Toggle switch to control power flow between plug-in adapter and fixture. Dimensions: 2.50 x 0.90 x 0.70 in.	
DI-INLINE-OS-5A-W DI-INLINE-OS-5A-B	WH <input type="checkbox"/> BK <input checked="" type="checkbox"/>	Single	All Models 12V: 60W 24V: 100W	INLINE LED ON/OFF SWITCH- 5A 5A Toggle switch to control power flow between plug-in adapter and fixture. Dimensions: 2.50 x 0.90 x 0.70 in.	
DI-0715 DI-0715B	WH <input type="checkbox"/> BK <input checked="" type="checkbox"/>	Single	All Models 12V: 24W 24V: 48W	INLINE LED DIMMER SWITCH Rotary dimmer controls power flow between plug-in adapter and fixture. Dimensions: 2.60 x 1.40 x 1.30 in.	
DI-INLINE-DS-5A-W DI-INLINE-DS-5A-B	WH <input type="checkbox"/> BK <input checked="" type="checkbox"/>	Single	All Models 12V: 60W 24V: 100W	INLINE LED DIMMER SWITCH- 5A 5A Rotary dimmer controls power flow between plug-in adapter and fixture. Dimensions: 2.60 x 1.40 x 1.30 in.	

# MECHANICAL DIAGRAMS *(Images are not to scale)*

## 24V 12W Models

DI-PA-24V12W-CL2-B  
DI-PA-24V12W-CL2-W

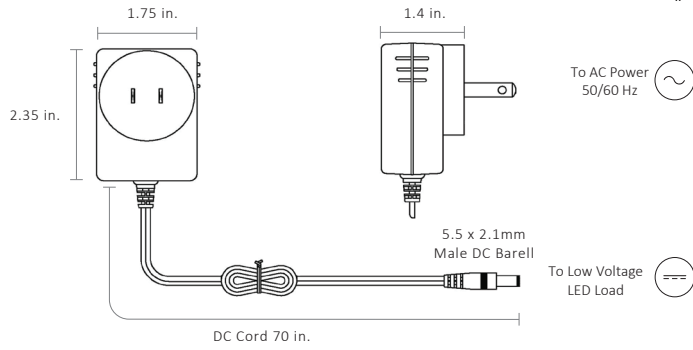

## 24V 24W Models

DI-PA-24V24W-CL2-B  
DI-PA-24V24W-CL2-W

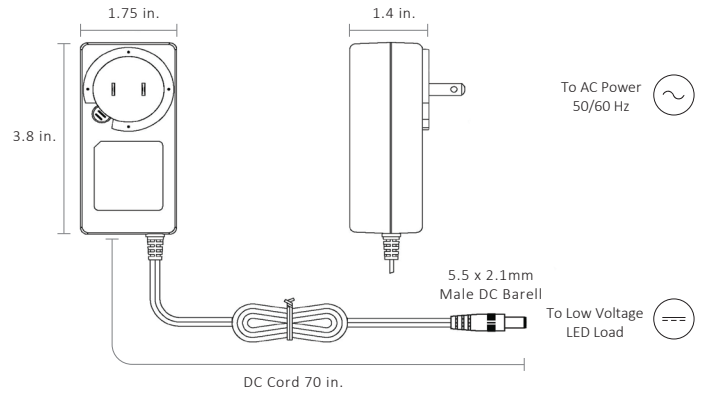

## 24V 48W Models

DI-PA-24V48W-CL2-B  
DI-PA-24V48W-CL2-W

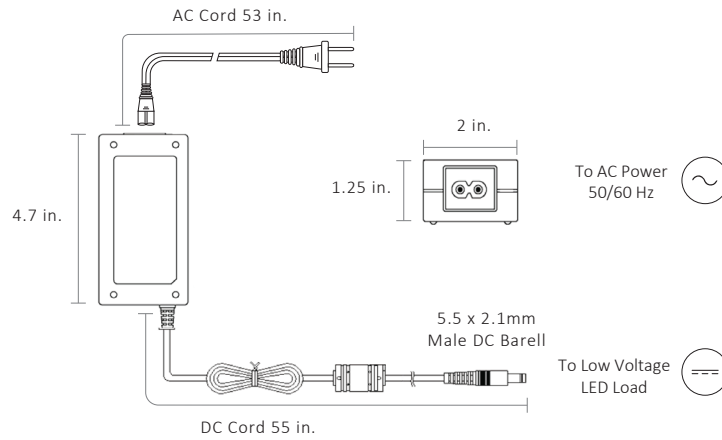

## 24V 96W Models

DI-PA-24V96W-CL2-B  
DI-PA-24V96W-CL2-W

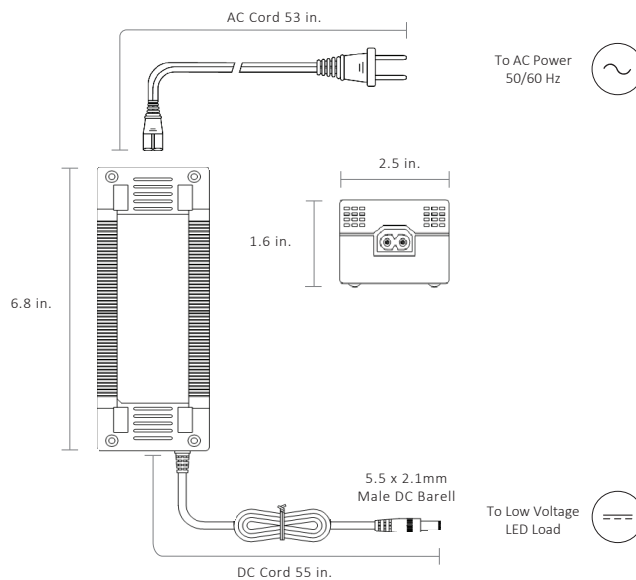

## ADDITIONAL RESOURCES

24VDC Commercial Grade Plug-In Adapter Specification Sheet

12VDC Commercial Grade Plug-In Adapter Specification Sheet

12VDC Plug-In Adapter Specification Sheet

## SAFETY / WARNINGS / DISCLOSURES

1. Install in accordance with national and local electrical code regulations.
2. This product is intended to be installed and serviced by a qualified, licensed electrician.
3. DO NOT modify product beyond instructions or warranty will be void.
4. Turn power OFF at main breaker before servicing or installing this product.
5. It is recommended to derate the plug-in adapter to 80% of the full labeled load for maximum longevity.
6. Do not install product in an environment outside the listed ambient temperature.
7. Operating temperature is measured according to the minimum and maximum ambient temperature environment.
8. Proper heat dissipation will prolong the working lifespan of this product. Install in a well-ventilated area free from explosive gases and vapors.
9. Ensure a compatible LED fixture with the correct operating voltage is installed with this product.
10. Drivers in this specification sheet are not compatible with 120VAC dimming controls. These adapters may be paired with low voltage In-Line Switches, Dimmers and RGB(W)/DMX Controls. The PWM dimmer/control spec sheet will indicate if multiple controls can be paired to a single driver.
11. To compensate for voltage drop, ensure applicable gauge in-wall rated wire is installed between driver and LED fixture.

## WARRANTY

### Limited Warranty

This product has a one (1) year limited warranty from the date of shipment. This warranty does not include the additional accessories referenced in this specification sheet. Complete warranty details for fixtures and additional accessories are available at [www.diodeled.com/limited-warranty/](http://www.diodeled.com/limited-warranty/) within the Policies section. For warranty related questions please contact product support.

### Consumer's Acknowledgment

Diode LED stands behind its products when they are used properly and according to our specifications. By purchasing our products, the purchaser agrees and acknowledges that lighting design, configuration and installation is a complex process, wherein seemingly minor factors or changes in layout and in-field adjustments can have a significant impact on an entire system. Choosing the correct components is essential. Diode LED is able to work with the original purchaser to make an appropriate product selection to the extent of the limited information that the customer can provide, but it is virtually impossible for Diode LED to design a system that foresees every unknown factor. For this reason, this Warranty does not cover problems caused by improper design, configuration or installation issues. Any statement from a Diode LED employee or agent regarding a customer's bill of goods and/or purchase order is NOT an acknowledgment that the products purchased are designed and configured correctly. The purchaser agrees and acknowledges that it is the customer's responsibility to adhere strictly to all information contained in the Product Specification Sheets.

There is often more than one way to design, configure and layout an LED lighting application properly to achieve the same lighting effect. Diode LED strongly recommends that licensed professionals be used in the design and installation of lighting systems that include Diode LED products. The specifications include important information that a designer and installer should carefully review and strictly follow. Qualified designers and certified and/or licensed installers, with access to the final installation environment, customer goals, and Diode LED product specifications can make the requisite decisions appropriate for a successful finished lighting application.



© 2017 Elemental LED, Inc. All rights reserved.  
Specifications are subject to change without notice.

Toll Free: 877.817.6028 | Fax: 415.592.1596 | [www.DiodeLED.com](http://www.DiodeLED.com) | [info@DiodeLED.com](mailto:info@DiodeLED.com)