

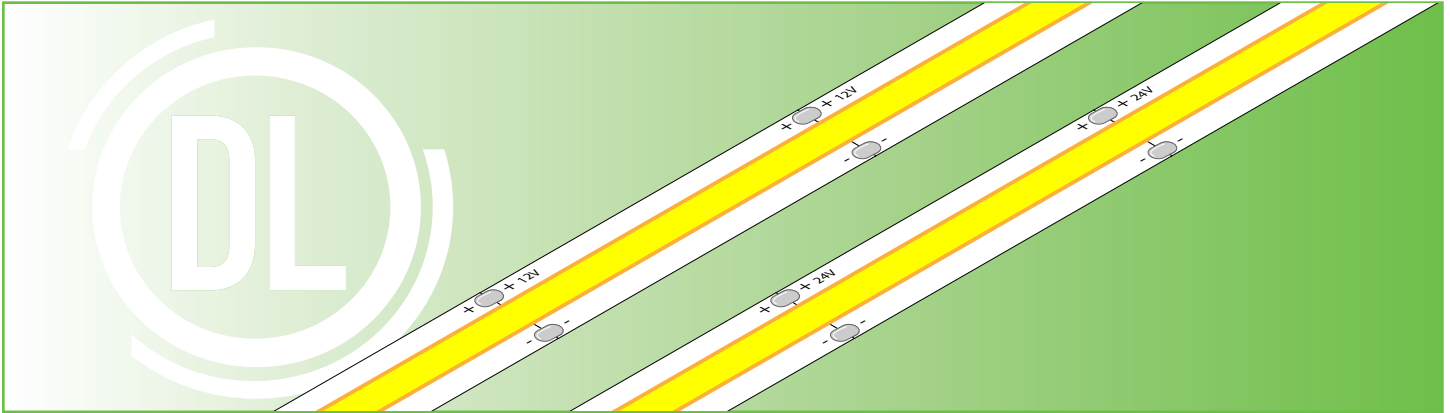

Item # _____

Project _____



SPECIFICATIONS

		STMLT	
Voltage		12VDC	24VDC
Wattage		3.3W/ft.	
Lumens¹	2700K	-	288/ft.
	3000K	286/ft.	292/ft.
	4000K	317/ft.	323/ft.
	RED	-	42/ft.
	GREEN	-	236/ft.
Max. Run²		16.4 feet	
Cut Points		1.4 in	2.5 in.
CRI		90+	
Dimmable		Yes	
Field Cuttable		Yes	
Dimensions		0.31 x 0.13 in. (W x H)	
Environment*		Indoor / Damp Location	
Certification		UL Listed	
Warranty		5-Year Warranty	

WARNING: NOT FOR USE IN SUBMERSIBLE APPLICATIONS

STREAMLITE™ DIFFUSED COB LINEAR LIGHT

SPECIFICATION SHEET

CUSTOM LENGTH TAPE

SKU Builder



DI

-

-

STMLT

-

-

Voltage

Voltage
12V*
24V

Model

Color Temp

COLOR TEMP
27
30*
40*
RD
GN

Length

LENGTH
CSTM (in.)
016

Example: DI-24V-STMLT-30-016 = Diode LED, 24 Volt, STREAMLITE™, 3,000° CCT, 16.4 foot spool.

NOTE: All custom cut Tape Lights include 96" lead wires.

* 12V Streamlite available in 3000K and 4000K CCT's

MECHANICAL DIAGRAM

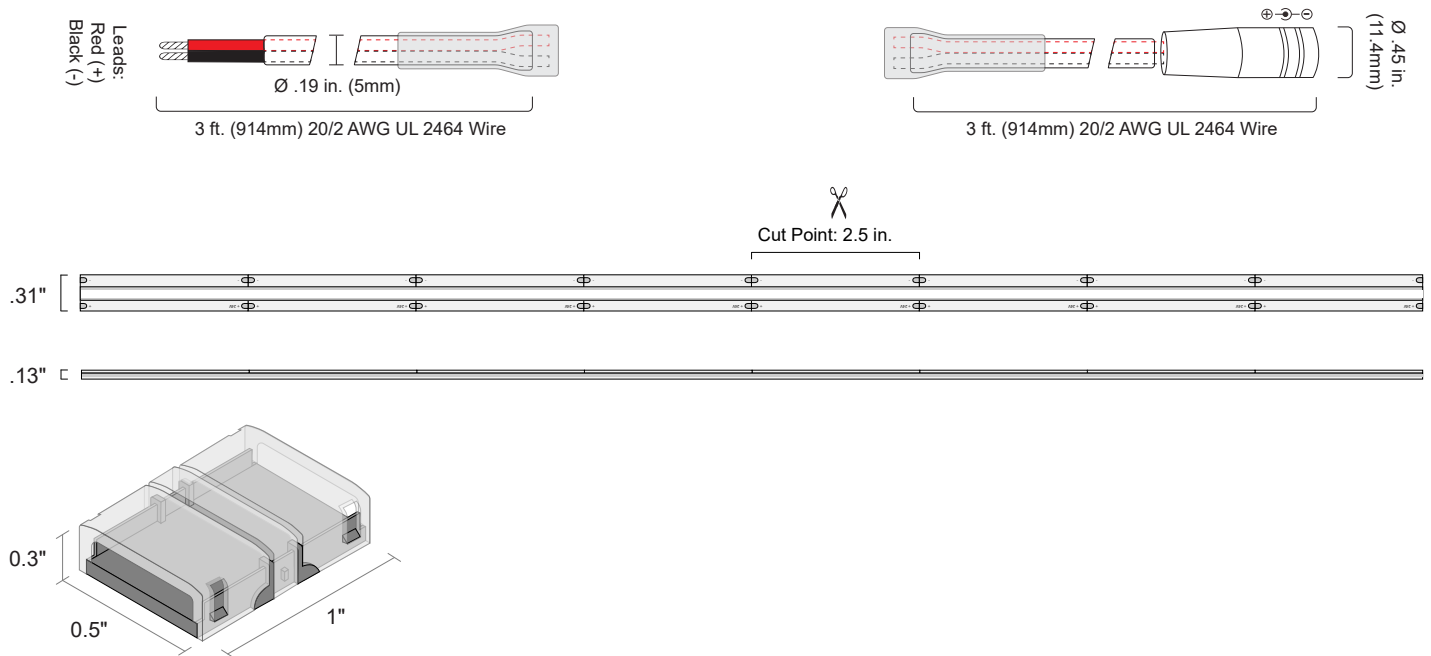

1. Lumen value measured in accordance to IES LM-80-08. LED chips have a luminous flux range with a tolerance of +/- 5%.
2. Each maximum run requires a dedicated power feed from the driver. Do not extend beyond the recommended maximum run length. Max run may exceed Class 2 limit. Actual wattage may differ from calculated wattage due to voltage drop across run.
3. Actual efficacy value is dependent to specified LED driver (power supply). An estimated efficacy value can be calculated as follows: Lumen value divided by average power consumption per foot.
4. Do not install product in an environment outside the listed ambient temperature. Exceeding the maximum ambient temperature may damage LED chips, reduce the total lamp life, lumen output, and/or adversely impact color consistency.
5. Operating temperature is measured according to the minimum and maximum ambient temperature environment.

STREAMLITE™ DIFFUSED COB LINEAR LIGHT

SPECIFICATION SHEET

BUILDER CHANNELS

NOTE: Builder channel covers are sold separately.

BUILDER SLIM (SL)

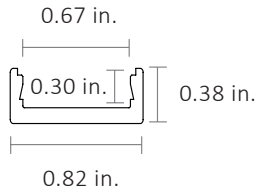

CHANNEL ONLY SKU	FINISH	LENGTH	PRODUCT INCLUDES
DI-CPCHA-SL48**	AL	48 in.	Mounting Clips sold separately.
DI-CPCHA-SL48W**	WH		
DI-CPCHA-SL48B**	BL		
DI-CPCHA-SL96**	AL	96 in.	
DI-CPCHA-SL96W**	WH		
DI-CPCHA-SL96B**	BL		

BUILDER 45° (45)

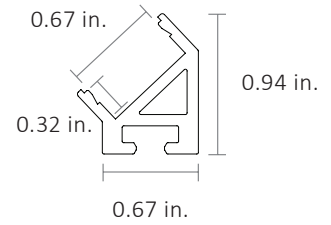
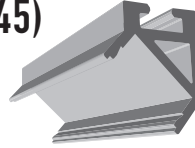

CHANNEL ONLY SKU	FINISH	LENGTH	PRODUCT INCLUDES
DI-CPCHA-4548**	AL	48 in.	4 Mounting Clips with screws and 2 End-to-End Interconnects.
DI-CPCHA-4548W**	WH		
DI-CPCHA-4548B**	BL		
DI-CPCHA-4596**	AL	96 in.	8 Mounting Clips with screws and 4 End-to-End Interconnects.
DI-CPCHA-4596W**	WH		
DI-CPCHA-4596B**	BL		

** - SKUs listed above are for Single Channels only. Add a -10 for a 10 pack bundle (10 pack will include 10x the amount included accessories)

BUILDER SQUARE (SQ)

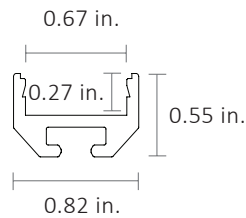
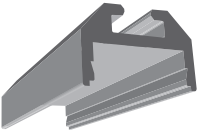

CHANNEL ONLY SKU	FINISH	LENGTH	PRODUCT INCLUDES
DI-CPCHA-SQ48**	AL	48 in.	4 Mounting Clips with screws and 2 End-to-End Interconnects.
DI-CPCHA-SQ48W**	WH		
DI-CPCHA-SQ48B**	BL		
DI-CPCHA-SQ96**	AL	96 in.	8 Mounting Clips with screws and 4 End-to-End Interconnects.
DI-CPCHA-SQ96W**	WH		
DI-CPCHA-SQ96B**	BL		

BUILDER DUO

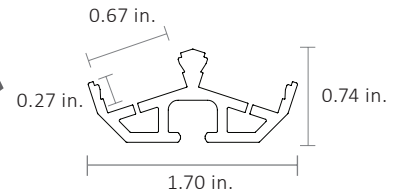
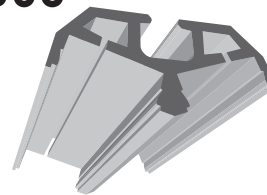

SKU	FINISH	LENGTH	PRODUCT INCLUDES
DI-CPCHA-DU48**	AL	48 in.	4 Mounting Clips
DI-CPCHA-DU48W**	WH		
DI-CPCHA-DU48B**	BL		

** - SKUs listed above are for Single Channels. Add a -10 for a 10 pack bundle (10 pack will include 10x the amount included accessories)

STREAMLITE™ DIFFUSED COB LINEAR LIGHT

SPECIFICATION SHEET

BUNDLE CHANNELS

NOTE: Bundle channels are **not** interchangeable with each other **nor** compatible with **Builder** channels.

BUNDLE SLIM RECESSED (SLR)

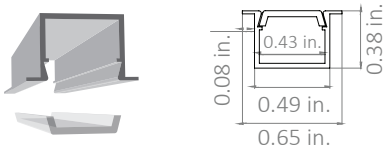

CHANNEL ONLY SKU

PRODUCT INCLUDES

DI-CPCHA-SLR48
DI-CPCHA-SLR96

- 48 and 96 in. channel & frosted cover
- End caps: 1x open square, 1x open round, 1x closed square.

BUNDLE RECESSED (REC)

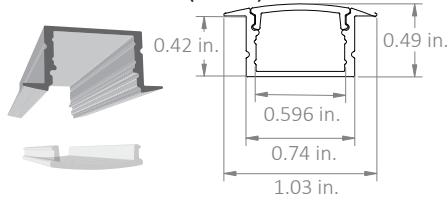

CHANNEL ONLY SKU

PRODUCT INCLUDES

DI-CPCHB-REC-48
DI-CPCHB-REC-96

- 48 and 96 in. channel & frosted cover
- End caps: 1x open, 1x closed
- Mounting hardware

BUNDLE 45° DECO (45DC)

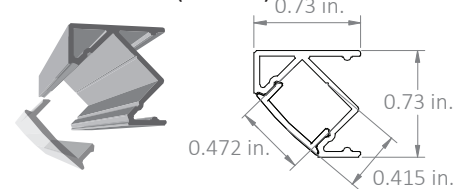

CHANNEL ONLY SKU

PRODUCT INCLUDES

DI-CPCHB-45DCO-48
DI-CPCHB-45DCO-96

- 48 & 96 in. channel & frosted cover
- End caps: 1x open, 1x closed
- Mounting hardware

BUNDLE REFLECTOR (RFC)

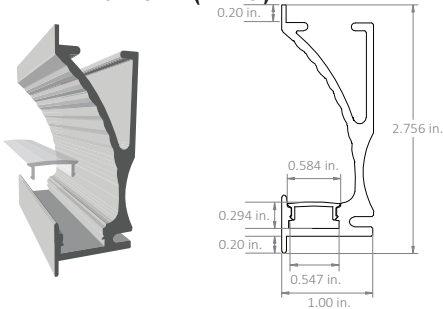

CHANNEL ONLY SKU

PRODUCT INCLUDES

DI-CPCHB-RFCTR-48
DI-CPCHB-RFCTR-96

- 48 and 96 in. channel & frosted cover
- End caps: 1x open, 1x closed

BUNDLE SCONCE (SCNC)

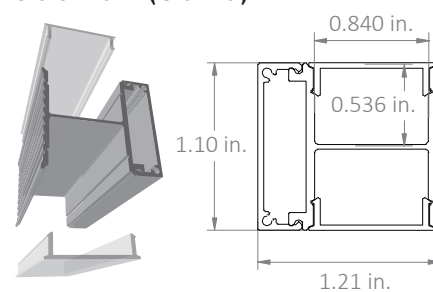

CHANNEL ONLY SKU

PRODUCT INCLUDES

DI-CPCHB-SCNC-48
DI-CPCHB-SCNC-96

- 48 and 96 in. channel, 48 in. mounting plate, 2x frosted covers
- End caps: 1x open, 1x closed

BUNDLE 90° SIDEVIEW (90DC)

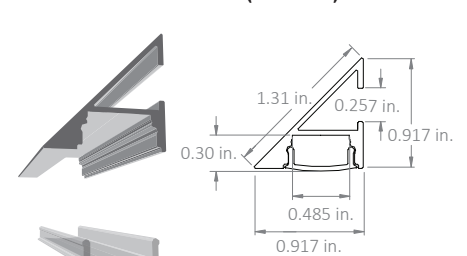

CHANNEL ONLY SKU

PRODUCT INCLUDES

DI-CPCHB-REC-48
DI-CPCHB-REC-96

- 48 and 96 in. channel & frosted cover
- End-caps: 1x open, 1x closed
- Mounting hardware

BUNDLE WAVEFORM (WF)

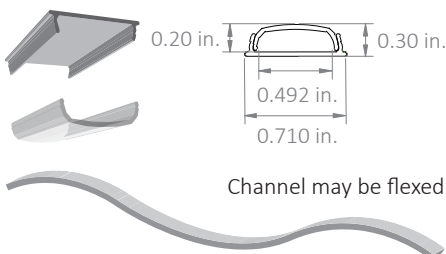

CHANNEL ONLY SKU

PRODUCT INCLUDES

DI-CPCHB-WF-48
DI-CPCHB-WF-96

- 48 and 96 in. channel & frosted cover
- End caps: 1x open, 1x closed
- 2x mounting clip

BUNDLE 10mm SQUARE CORNER (SQ10)

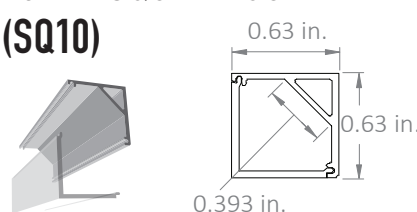

CHANNEL ONLY SKU

PRODUCT INCLUDES

DI-CPCHB-SQC10-48
DI-CPCHB-SQC10-96

- 48 and 96 in. channel & frosted cover
- End-caps: 1x open, 1x closed
- Mounting hardware

BUNDLE 10mm ROUNDED CORNER (RC10)

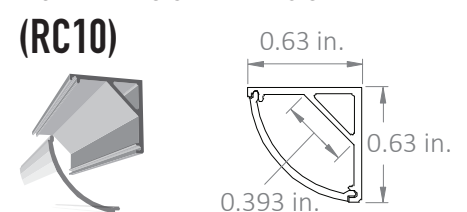

CHANNEL ONLY SKU

PRODUCT INCLUDES

DI-CPCHB-RC10-48
DI-CPCHB-RC10-96

- 48 and 96 in. channel & frosted cover
- End-caps: 1x open, 1x closed
- Mounting hardware

STREAMLITE™ DIFFUSED COB LINEAR LIGHT

SPECIFICATION SHEET

BUNDLE CHANNELS (CONT.)

BUNDLE DOME (DME)

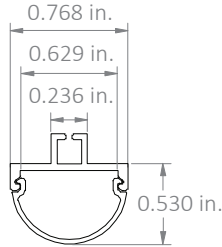
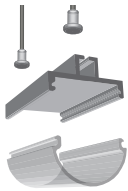

CHANNEL ONLY SKU

DI-CPCHB-DOME-48
DI-CPCHB-DOME-96

PRODUCT INCLUDES

- 48 and 96 in. channel & frosted cover
- End caps: 1x open, 1x closed
- 2x pendant hardware

BUNDLE 20mm SQUARE CORNER (SQ20)

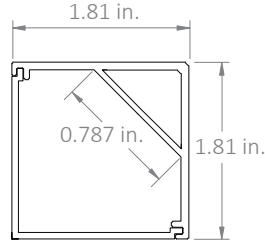

CHANNEL ONLY SKU

DI-CPCHB-SQC20-48
DI-CPCHB-SQC20-96

PRODUCT INCLUDES

- 48 and 96 in. channel & frosted cover
- End-caps: 1x open, 1x closed
- Mounting hardware

BUNDLE 20mm ROUNDED CORNER (RC20)

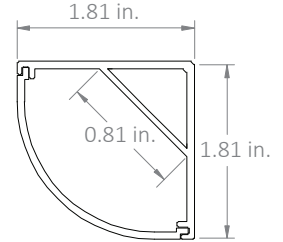

CHANNEL ONLY SKU

DI-CPCHB-RC20-48
DI-CPCHB-RC20-96

PRODUCT INCLUDES

- 48 and 96 in. channel & frosted cover
- End-caps: 1x open, 1x closed
- Mounting hardware

BUNDLE CANAL (CA)

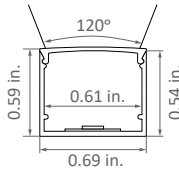
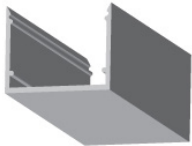

CHANNEL ONLY SKU

DI-CPCHB-CAN48

DI-CPCHB-CAN96

PRODUCT INCLUDES

- 48 and 96 in. channel & opal cover
- End caps: 1x open, 1x closed
- 2x mounting clip
- 96 in. channel & opal cover
- End caps: 2x open, 2x closed
- 4x mounting clip

BUNDLE GRAZER NARROW BEAM (GRZNB)

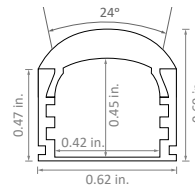
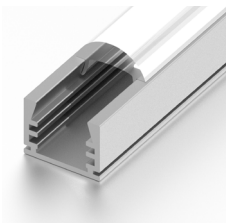

CHANNEL ONLY SKU

DI-CPCHB-GZRN-48

DI-CPCHB-GZRN-96

PRODUCT INCLUDES

- 48 in. channel & clear matte optic lens
- End caps: 48 in. 1x open, 1x closed
- 2x mounting clip
- 96 in. channel & clear matte optic lens
- End caps: 2x open, 2x closed
- 4x mounting clips

STREAMLITE™ DIFFUSED COB LINEAR LIGHT

SPECIFICATION SHEET

COMPATIBLE PRODUCTS

The following Listed LED Drivers are recommended for compatibility and to meet NEC code when installed according to specifications. For additional LED Driver options see Diode LED's product page at: <https://www.diodeled.com/products/led-power-supplies.html>

STAND ALONE

SWITCHEX® DRIVER + DIMMER SWITCH

SWITCHEX combines an LED driver and LED dimmer switch into a single integrated unit. Fits into standard switch boxes.

[SPEC SHEET](#)

	Voltage Output		Power Output
DI	24V	SE	60W

SKU	L - LENGTH	W - WIDTH	H - HEIGHT
DI-12V-SE-40W			
DI-12V-SE-60W	1.40 in.	2.10 in.	4.10 in.
DI-24V-SE-60W			
DI-24V-SE-100W			

Fits in Standard Switch Box

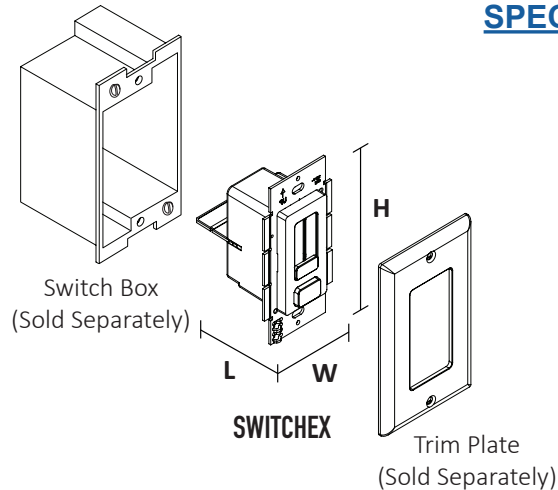

ELECTRONIC DRIVERS

OMNIDRIVE® 24V ELECTRONIC DIMMABLE LED DRIVER

Compatible with Forward Phase and Reverse Phase Dimmers. Please see Diode LED's Compatibility List at: <https://www.diodeled.com/custom/download/productFile/filename/dimmer-master-compatibility-guide.pdf>

[INDOOR SPEC SHEET](#)
[OUTDOOR SPEC SHEET](#)

		Voltage & Power Output
DI	TD	24V-10W

SKU		L - LENGTH	W - WIDTH	H - HEIGHT
DI-TD-12V-10W	a	5.5 in.	1.8 in.	1.1 in.
DI-TD-24V-10W	a	5.5 in.	1.8 in.	1.1 in.
DI-TD-12V-20W	a	5.5 in.	1.8 in.	1.1 in.
DI-TD-24V-20W	a	5.5 in.	1.8 in.	1.1 in.
DI-TD-12V-30W	a	7 in.	2.3 in.	1.4 in.
DI-TD-24V-30W	a	7 in.	2.3 in.	1.4 in.
DI-TD-12V-45W	a	7 in.	2.3 in.	1.4 in.
DI-TD-24V-45W	a	7 in.	2.3 in.	1.4 in.
DI-TD-12V-60W	b	7.9 in.	2.7 in.	1.8 in.
DI-TD-24V-60W	b	7.9 in.	2.7 in.	1.8 in.
DI-TD-24V-80W	b	7.9 in.	2.7 in.	1.8 in.
DI-TD-24V-96W	b	7.9 in.	2.7 in.	1.8 in.

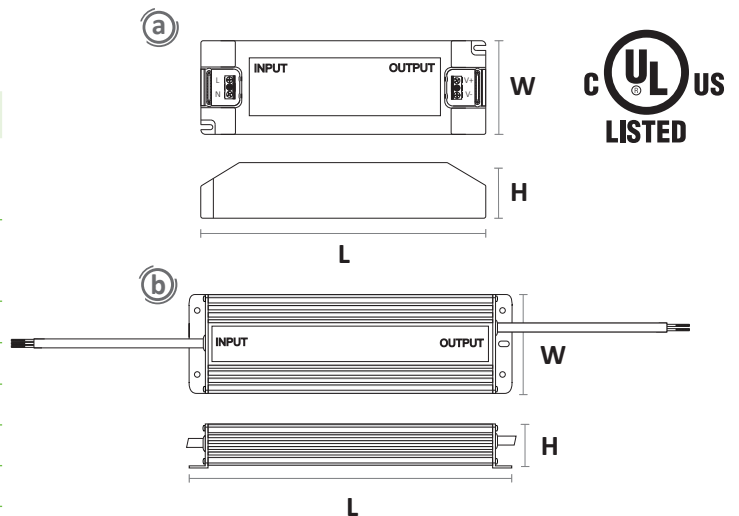

STREAMLITE™ DIFFUSED COB LINEAR LIGHT

SPECIFICATION SHEET

COMPATIBLE PRODUCTS

The following Listed LED Drivers are recommended for compatibility and to meet NEC code when installed according to specifications. For additional LED Driver options see Diode LED's product page at: <https://www.diodeled.com/products/led-power-supplies.html>

LUTRON OPTIONS

LUTRON® Hi-lume 1% LED DIMMABLE DRIVER

Hi-lume 1% LED Driver has a minimum load of 5W and dims from 100-1%.

	Voltage & Power Output	3-Wire or 2-Wire Dimmers
DI-DM	24V40W	L3D

SKU	L - LENGTH	W - WIDTH	H - HEIGHT
DI-DM-12V40W-L3D			
DI-DM-12V40W-LTE	4.89 in.	4.00 in.	2.62 in.
DI-DM-24V40W-L3D			
DI-DM-24V40W-LTE			

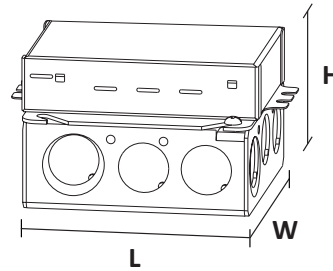

[L3D SPEC SHEET](#)

[LTE SPEC SHEET](#)



LUTRON® Hi-lume Premier 0.1% LED DIMMABLE DRIVER

Hi-Lume Premier 0.1% LED Driver has a minimum load of 5W and dims from 100-0.1%.

	Voltage & Power Output	
DI-DM	24V96W	L3D

SKU	L - LENGTH	W - WIDTH	H - HEIGHT
DI-DM-24V96W-L3D	5.50 in.	2.20 in.	10.50 in.

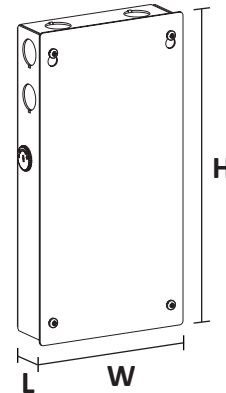

[SPEC SHEET](#)



STREAMLITE™ DIFFUSED COB LINEAR LIGHT

SPECIFICATION SHEET

COMPATIBLE PRODUCTS

The following Listed LED Drivers are recommended for compatibility and to meet NEC code when installed according to specifications. For additional LED Driver options see Diode LED's product page at: <https://www.diodeled.com/products/led-power-supplies.html>

ON/OFF, DMX, & PWM CONTROL

LO-PRO® JUNCTION BOX & DRIVER COMBO - 12/24V CONSTANT VOLTAGE LED DRIVER

Use Constant Voltage Drivers to power your lighting system. Compatible with Standard 120VAC On/Off Switches, REIGN® Low Voltage Dimmers, TOUCHDIAL™ Control System, DMX Decoders, and PWM Controls.

[SPEC SHEET](#)

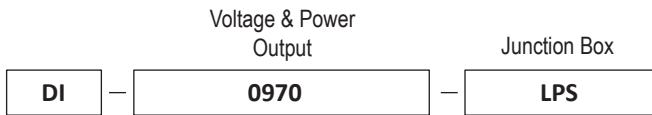

SKU	L - LENGTH	W - WIDTH	H - HEIGHT
DI-0904-LPS			
DI-0918-LPS			
DI-0906-LPS			
DI-0970-LPS	11.25 in.	3.75 in.	1.90 in.
DI-CV-MW24V60W-277-LPS			
DI-CV-MW24V90W-277-LPS			
DI-0954-LPL	13.5 in.	4.5 in.	2.37 in.

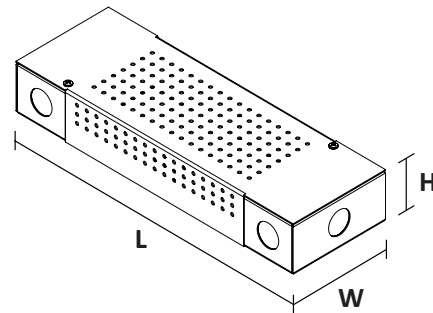

STREAMLITE™ DIFFUSED COB LINEAR LIGHT

SPECIFICATION SHEET

ACCESSORIES

STREAMLITE™ CONNECTOR

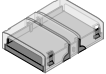
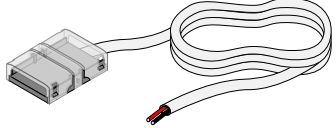
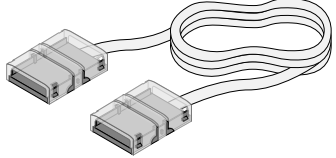
SKU	DESCRIPTION		
DI-STMLT-CKT-TTT-1	StreamLite Tape-to-Tape connector, no wire (Tape to Tape)	Attaches two sections of STREAMLITE™ Tape light together.	
DI-STMLT-CKT-SPL24-1	StreamLite Tape-to-Wire connector, 24 in. (Splice)	Attaches STREAMLITE™ Tape light directly to power supply.	
DI-STMLT-CKT12-EXT	StreamLite Tape-to-Tape plus 12 in. wire (Jumper)	Attaches two sections of STREAMLITE™ Tape light together. Wire lead allows for turns around tight corners.	

CHROMAPATH® BUILDER CHANNEL COVERS (individual*) - SLIM / SQUARE / 45° / DUO

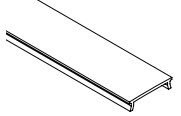
SKU	FINISH	FORM FACTOR	BUNDLES	DESCRIPTION	
DI-CPCHC-FR48**	Frosted	Frosted Cover (48 in.)	Single or 10 Pack	Protects LED tape light and slightly softens light. Note: there is an average warm shift in Kelvin of 35K and an average 28% decrease in delivered lumens.	
DI-CPCHC-FR96**	Frosted	Frosted Cover (96 in.)			
DI-CPCHC-CL48**	Clear	Clear Cover (48 in.)			
DI-CPCHC-CL96**	Clear	Clear Cover (96 in.)			

*not for use with Fully Loaded Channels

** - SKUs listed above are for Single covers. Add a -10 for a 10 pack bundle.

CHROMAPATH® BUILDER CHANNEL MOUNTING OPTIONS - SLIM

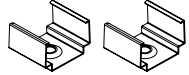
SKU	FINISH	FORM FACTOR	BUNDLES	DESCRIPTION	
DI-1633	N/A	SLIM Mounting Tape (TP)	4 ft. x 0.75 in.	3M® high-bond double-sided adhesive tape designed to install the CHROMAPATH SLIM on a flat, indoor surface.	
DI-1634			12 ft. x 0.75 in.		
DI-CPCH-UC-BA DI-CPCH-UC-WH DI-CPCH-UC-BL	AL WH BL	SLIM Mounting U-Clips	Pack of 2 clips / 4 screws	Secure SLIM Channel to flat surface with this pressure-fit clip. Also compatible when installed with PREMIUM DIFFUSION cover. Adds 0.12in. height to channel.	

STREAMLITE™ DIFFUSED COB LINEAR LIGHT

SPECIFICATION SHEET

ACCESSORIES (CONT.)

CHROMAPATH® BUILDER CHANNEL MOUNTING OPTIONS - SQUARE / 45° / DUO

SKU	FINISH	FORM FACTOR	BUNDLES	DESCRIPTION	
DI-CPMC2-SCR4	Steel	Mounting Clips (MTC)	Pack of 2 clips / 4 screws	Secure CHROMAPATH to flat surface with this pressure-fit clip. Adds 0.12in. height to channel.	
DI-1630-20			Pack of 20 clips / 40 screws		
DI-1912	Steel	Vertical Mounting Brackets (VERT)	Pack of 2	Used to install CHROMAPATH in a vertical orientation and includes an Allen key and allen screws for securing to a vertical surface. Note: Mounting Clips, or Rotating Mounting Clips required for installation of Vertical Mounting Brackets.	
DI-CPCH-HNG	Steel	Hanging Hardware Kit (HNG)	Pack of 2 hanging mounts / 2 Wire restrainers / 4 screws	Transform your CHROMAPATH Channel into a pendent fixture with CHROMAPATH Hanging Hardware Kit.	
DI-CPCH-RC-BA	AL	Rotating Mounting Clips (RTC)	Pack of 2 clips / 4 screws	Secure CHROMAPATH to flat surface and adjust to desired angle with this pressure-fit clip. Adds 0.74in. height to channel.	
DI-CPCH-RC-WH	WH				
DI-CPCH-RC-BL	BL				

SPECIFICATIONS

- Input: 24VDC Constant Voltage
- LED Chip Beam Angle: 120°
- Luminous Efficacy³ (lm/w): 87~97
- Mounting: 3M mounting tape on back of tape.
- Connections: 36" female DC lead, and 36" bare lead: 22/2 AWG
- Ambient Temp⁴: -4 - 122°F (-20 ~ 50°C)
- Operating Temp⁵: -4 - 176°F (-20 ~ 80°C)

COMPLIANCE & REGULATORY APPROVALS

Safety

- UL Listed 2108 Flexible Lighting Systems. Certified for United States and Canada. File # E469769.

Performance

- Photometric & Colorimetry data measured in accordance to IES LM-79-08, in Elemental LED's Innovation Lab.

SPECIFYING?

Note: The compatible products listed in this Specification Sheet are provided for reference only. For complete specifications of compatible products, click on the [SPEC SHEET](#) links provided.

STREAMLITE™ DIFFUSED COB LINEAR LIGHT

SPECIFICATION SHEET

SAFETY / WARNINGS / DISCLOSURES

1. Install in accordance with national and local electrical code regulations.
2. This product is intended to be installed and serviced by a qualified, licensed electrician.
3. Only install with a listed Class 2 DC Constant Voltage LED Driver.
4. Not for use in or on walls of pools, fountains, or other partially or fully submersed locations.
5. Do not modify or disassemble product beyond instructions or this warranty will be void.
6. Actual color may vary from what is pictured above and on other print materials due to the limitations of photographic processes.
7. We reserve the right to modify and improve the design of our fixtures without prior notice. We cannot guarantee to match existing installed fixtures for subsequent orders or replacements in regards to product appearance, CCT, or lumen output.

WARRANTY

Limited Warranty

This product has a five (5) year limited warranty from the date of shipment. This warranty does not include the additional accessories referenced in this specification sheet. Complete warranty details for fixtures and additional accessories are available at www.diodeled.com/limited-warranty/ within the Policies section. For warranty related questions please contact product support.

Consumer's Acknowledgment

Elemental LED, Inc. stands behind its products when they are used properly and according to our specifications. By purchasing our products, the purchaser agrees and acknowledges that lighting design, configuration and installation is a complex process, wherein seemingly minor factors or changes in layout and infield adjustments can have a significant impact on an entire system. Choosing the correct components is essential. Elemental LED is able to work with the original purchaser to make an appropriate product selection to the extent of the limited information that the customer can provide, but it is virtually impossible for Elemental LED to design a system that foresees every unknown factor. For this reason, this Warranty does not cover problems caused by improper design, configuration or installation issues. Any statement from an Elemental LED employee or agent regarding a customer's bill of goods and/or purchase order is NOT an acknowledgment that the products purchased are designed and configured correctly. The purchaser agrees and acknowledges that it is the customer's responsibility to adhere strictly to all information contained in the Product Specification Sheets.

There is often more than one way to design, configure and layout an LED lighting application properly to achieve the same lighting effect. Elemental LED strongly recommends that licensed professionals be used in the design and installation of lighting systems that include Elemental LED products. The specifications include important information that a designer and installer should carefully review and strictly follow. Qualified designers and certified and/or licensed installers, with access to the final installation environment, customer goals, and Elemental LED product specifications can make the requisite decisions appropriate for a successful finished lighting application.



© 2021 Elemental LED, Inc. All rights reserved.
Specifications are subject to change without notice.

Toll Free: 877.817.6028 | Fax: 415.592.1596 | www.DiodeLED.com | info@DiodeLED.com