

TRIAN T[®] 2
12V / 24V LED PUCK LIGHT

SPECIFICATION SHEET

- Dual input voltage 12/24V
- Surface and recess mounting
- Available in 3 finishes
- ETL Listed
- 5-Year limited warranty

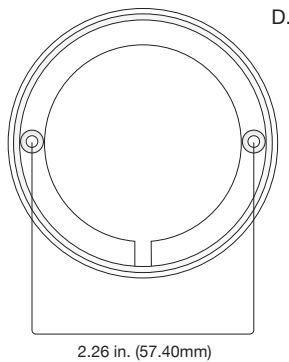
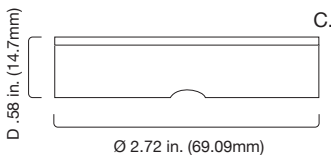
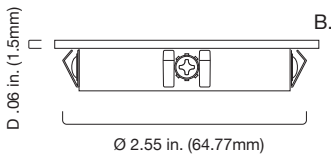
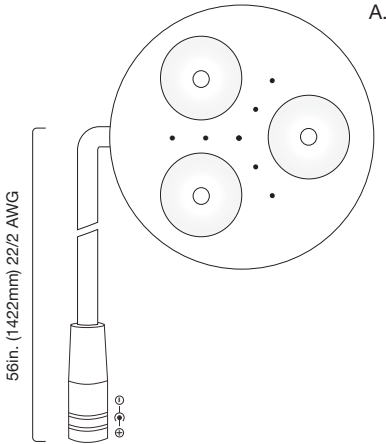

A. Top View
B. Side Recessed View (No Mount Ring)
C. Side View
D. Surface Mount Ring

SPECIFICATIONS

Input Voltage: 12VDC / 24VDC Constant Voltage
Power Consumption / ft.: 3.3W
LED Chip Beam Angle: 120°
Mounting: Surface or recess mount (suitable for recess mount only inside cabinet/shelf)
Connections ¹: 56 in. female DC plug, Leads: 22/2 AWG
Dimmable: No
Ambient Temp ²: -4 ~ 122°F (-20 ~ 50°C)

Operating Temp ³: -4 ~ 176°F (-20 ~ 80°C)
Environment ⁴: Indoor / dry location
Dimensions: 2.72 x 0.58 in. (Dia x Depth), 2.5 in. (Recessed Dia)
Certifications: ETL Listed
Included Items: 1 surface mount ring, 2 mounting screws

Item #	CCT (Kelvin)	Lumens / ft. ⁵	CRI	Efficacy (lm/W) ⁶
DI-1224V-TRNT2-30-AL (aluminum finish)	3000K	12V - 361	90+	118.78
DI-1224V-TRNT2-30-BL (anodized black finish)		24V - 392		
DI-1224V-TRNT2-30-WH (gloss white finish)				
DI-1224V-TRNT2-50-AL (aluminum finish)	5000K	12V - 370	90+	120.90
DI-1224V-TRNT2-50-BL (anodized black finish)		24V - 399		
DI-1224V-TRNT2-50-WH (gloss white finish)				





- Note ¹** Attached connectors and connector accessories are not rated for in-wall installation unless otherwise noted. Attached connections are field cuttable.
- Note ²** Do not install product in an environment outside the listed ambient temperature. Exceeding the maximum ambient temperature may damage LED chips, reduce the total lamp life, lumen output, and/or adversely impact color consistency.
- Note ³** Operating temperature is measured according to the minimum and maximum ambient temperature environment.
- Note ⁴** Do not install in environment where LED chips are exposed to direct sunlight as damage to the phosphor will occur.
- Note ⁵** Lumen value measured in accordance to IES LM-79-08. LED chips have a luminous flux range with a tolerance of +/- 5%.
- Note ⁶** Actual efficacy value is dependent to specified LED driver (power supply). An estimated efficacy value has been provided and calculated as follows: Lumen value (measured in accordance to IES LM-79-08) divided by average power consumption per fixture.

Diode LED	Voltage	Model	CCT	Color
DI	-	-	-	-
	1224V	TRNT2	3000K 5000K	AL BL WH

Item #:	Project:
---------	----------

ACCESSORIES

All fixture accessories including DC connections, etc. have a Class 2 amperage rating unless otherwise noted (60W/5A @ 12V DC; 100W/4.17A @ 24V DC).

Item #	Type	Description	Image
DI-PVC2464-DL42-SPL-F-**	Adapter Splice Cable - Female	Converts a male DC plug to a hard-wired connection. Wire: 22/2 AWG. Dimensions: 42 x 0.45 in. (L x W)	
DI-PVC2464-DL42-SPL-M-**	Adapter Splice Cable - Male	Converts a female DC plug to a hard-wired connection. Wire: 22/2 AWG. Dimensions: 42 x 0.45 in. (L x W)	
DI-0708-**	39 in. DC Extension Cable	Creates an extension between DC plugs. Wire: 20/2 AWG. Connector width: 0.45 in.	
DI-0720-** (2-way) DI-0705-** (3-way) DI-DCSP4-** (4-way) DI-0707-** (5-way)	DC Splitter	Splits a DC connection. Wire: 20/2 AWG. Dimensions: 8 x 0.6 x 0.3 in. (L x W x H)	

** Products available in 5x and 25x pack bulk quantities. Add -5 or -25 to each product # for bulk quantities.

SWITCHES, CONTROLS, LED DRIVERS, & SYSTEM DIAGRAMS

We offer a variety of switches, controls, and LED drivers (power supplies) to address all common light installations. For additional information, please see the additional component sections of our website or catalog. See the 'TRIAN® 2 12V-24V LED Puck Light Installation Guide' for system diagrams and installation instructions. For additional questions and concerns please contact technical support.

ADDITIONAL RESOURCES

Visit the on line product page at www.DiodeLED.com for additional resources including:

- **TRIAN® 12V-24V LED PUCK LIGHT Installation Guide**
For system diagrams and full installation instructions.
- **Voltage Drop Charts**
Use to specify appropriate wire gauge for installation. Available at the 'Tools & Resources' page at www.DiodeLED.com.

SAFETY & DISCLOSURES

- Install in accordance with the National Electric Code and local regulations.
- This product is intended to be installed and serviced by a qualified, licensed electrician.
- This product requires a compatible LED driver for proper configuration. Do not connect directly to high voltage 120~277V AC power.
- The UL Listing of this product requires the fixture to be powered with a compatible Class 2 DC constant voltage LED driver (power supply).
- It is generally recommended to load the driver no more than 80% the labeled rating for maximum performance and longevity. However, see each driver specification sheet for exact minimum and maximum loading values.
- Do not install product in an environment outside the listed ambient temperature. Exceeding the maximum ambient temperature may damage LED chips, reduce the total lamp life, lumen output, and/or adversely impact color consistency.
- Operating temperature is measured according to the minimum and maximum ambient temperature environment.
- Do not install in environment where LED chips are exposed to direct sunlight as damage to the phosphor will occur.
- Ensure applicable wire is installed between driver, fixture, and any controls in-between. When choosing wire, factor in voltage drop, amperage rating, and type (in-wall rated, wet location rated, etc.). Inadequate wire installation could overheat wires, and cause fire.
- Attached wire leads or wire accessories are not rated for in-wall installation unless otherwise noted.
- 'Voltage drop' is a gradual decrease in voltage along a conductor through which current is flowing. When specifying an LED system, ensure to calculate voltage drop appropriately. Voltage drop calculators will suggest the proper gauge wire and distance to install the driver from the fixture. To meet maximum performance, the beginning of the tape light should be receiving no less than 3% of input power rating.
- All fixture accessories including CLICKTIGHT™ connectors, DC connections, etc. have a Class 2 amperage rating unless otherwise noted (60W/5A @ 12V DC; 100W/4.17A @ 24V DC).
- Do not modify or disassemble this product beyond instructions or the warranty will be void. Attached connections are field cuttable and will not void warranty if modified.
- Actual color may vary from what is pictured on this sheet and other print materials due to the limitations of photographic processes.
- Lighting technology has some amount of gradual light degradation (output and/or color) over the lifespan of the products. Diode LED products are designed to minimize degradation, but some light degradation and color shift is a normal part of the life span of any LED lighting system.
- We reserve the right to modify and improve the design of our fixtures without prior notice. We cannot guarantee to match existing installed fixtures for subsequent orders or replacements in regards to product appearance, CCT, or lumen output.

WARRANTY INFORMATION

Limited Warranty

This LED fixture has a five (5) year limited warranty from the date of shipment. This warranty does not include the additional accessories referenced in this specification sheet. Complete warranty details for fixtures and additional accessories are available at www.DiodeLED.com under the 'Tools & Resources' tab. For warranty related questions, please contact customer service.

Consumer's Acknowledgment

Diode LED stands behind its products when they are used properly and according to our specifications. By purchasing our products, the purchaser agrees and acknowledges that lighting design, configuration and installation is a complex process, wherein seemingly minor factors or changes in layout and infield adjustments can have a significant impact on an entire system. Choosing the right components is essential. Diode LED is able to work with the original purchaser to make an appropriate product selection to the extent of the limited information that the customer can provide, but it is virtually impossible for Diode LED to design a system that foresees every unknown factor. For this reason, this Warranty does not cover problems caused by improper design, configuration or installation issues. Any statement from a Diode LED employee or agent regarding a customer's bill of goods and/or purchase order is NOT an acknowledgment that the products purchased are designed and configured correctly. The purchaser agrees and acknowledges that it is the customer's responsibility to adhere strictly to all information contained in the Product Specification Sheets.

There is often more than one way to design, configure and layout an LED lighting application properly to achieve the same lighting effect. Diode LED strongly recommends that licensed professionals be used in the design and installation of lighting systems that include Diode LED products. The specifications include important information that a designer and installer should carefully review and strictly follow. Qualified designers and certified and/or licensed installers, with access to the final installation environment, customer goals, and Diode LED product specifications can make the requisite decisions appropriate for a successful finished lighting application.



Toll Free: 877.817.6028 | Fax: 415.592.1596 | www.DiodeLED.com | info@DiodeLED.com
© 2015 Elemental LED, Inc. All rights reserved. Specifications are subject to change without notice.