

INSTALLATION INSTRUCTIONS

SPKPL-REC-TB-5CH



⚠ WARNING

These products may represent a possible shock or fire hazard if improperly installed or attached in any way. Products should be installed in accordance with these instructions, current electrical codes, and/or the current National Electric Code (NEC).

⚠ WARNING

This receiver requires a 12-24V DC power supply (ADPT series hardwire drivers recommended, sold separately). Disconnect supply power at the source prior to installation.

SAFETY INFORMATION

- Read all instructions before beginning; save these instructions for future use.
- To reduce the risk of fire, electric shock, or injury to person(s), pay close attention to this manual and stay within its guidelines when using this product.
- This receiver is rated IP20; avoid sun and moisture exposure.
- Avoid using receiver in areas where extreme hot, cold, dust, or humidity exist.
- This receiver is suitable for indoor, dry locations only.
- Always be sure to mount this controller in an area with proper ventilation to avoid overheating. This product has an operating temperature range of -10°C (14°F) to 40°C (104°F).
- Never connect any cables while power is on and always ensure correct connections to avoid short circuits prior to switching on. Ensure all wires and cables are secured tightly in the connector prior to operation.
- For cleaning, use a soft, dry cloth. Do not use harsh chemicals or abrasives.
- This receiver is rated for 12-24V DC input with a 0.5W minimum load requirement.
- This receiver has a maximum output of 48W (12V DC) or 96W (24V DC) per channel.

CONNECTING POWER TO THE RECEIVER (See Figure 1): This receiver requires a 12-24V DC power supply (ADPT series hardwire drivers recommended, sold separately). Disconnect power at the source prior to installation.

1. Ensure all wiring connections to fixtures are made prior to connecting power to smart receiver. See “Installing & Wiring Smart Receiver” with Figures 2-6.
2. When using a hardwire driver, make connections according to polarity using the screw-down terminal ports (+ to + and - to -).
3. When using a plug-in style driver, insert the male DC connection from the driver into the female DC connection of the receiver.
4. Connect the smart driver to a 120V power source according to power supply installation instructions.

INSTALLING & WIRING SMART RECEIVER (See Figures 2 to 6):

1. Determine desired location of receiver. Receiver can be surface mounted via screws through the mounting holes on either end.
2. This receiver has 5 x 4A current output terminals that can be used in conjunction with the Spektrum+ Smart Lighting App or SPKPL-CTRL-W-RGBTW to control Single Color, Tunable White, RGB, RGBW, and RGB+Tunable White fixtures. Wire the receiver to a fixture by following the fixture’s instruction manual and wiring diagrams below, ensuring to match polarity (wiring varies depending on product) using the screw-down terminal ports. Connect fixture prior to bringing any power to the system. (See Figures 2-6) Continued on back.

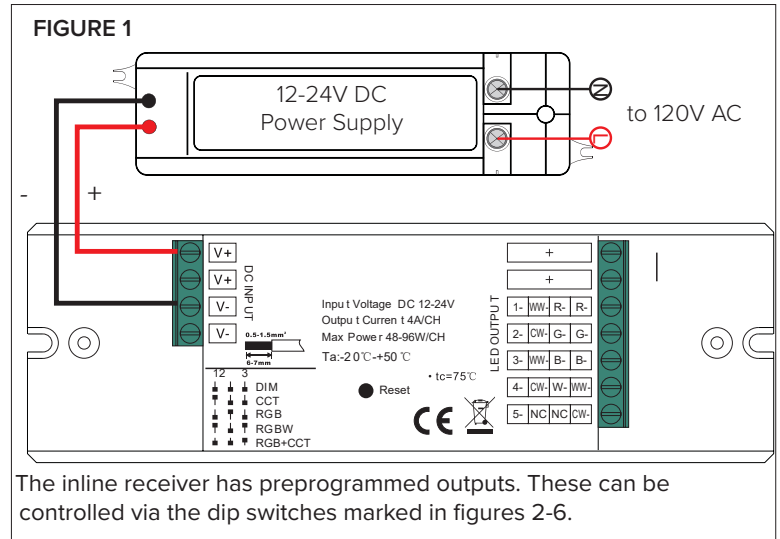

FIGURE 2 - Single Color (2-Wire) Wiring Diagram

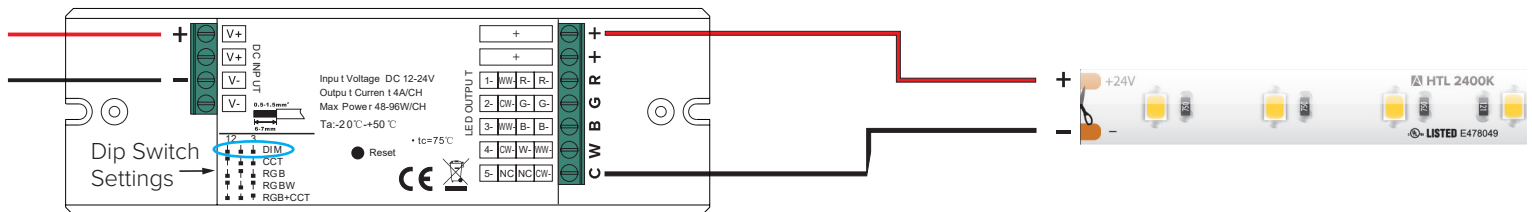
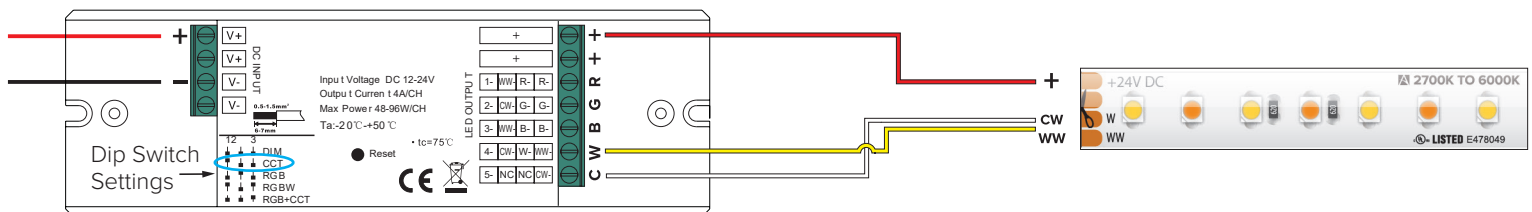
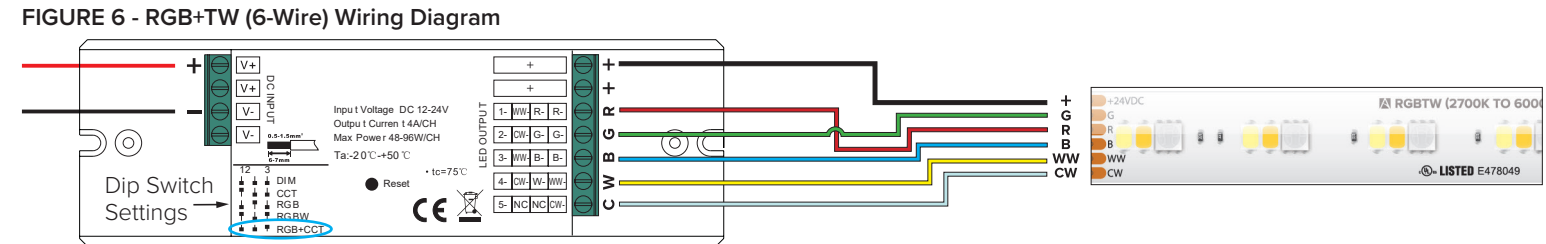
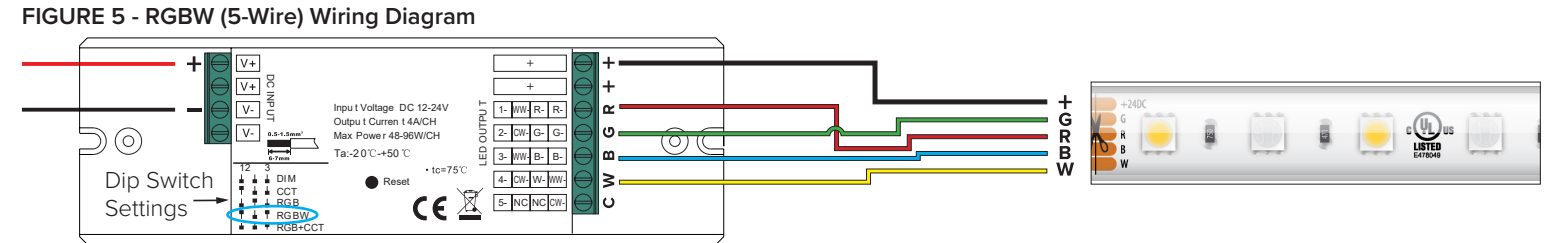
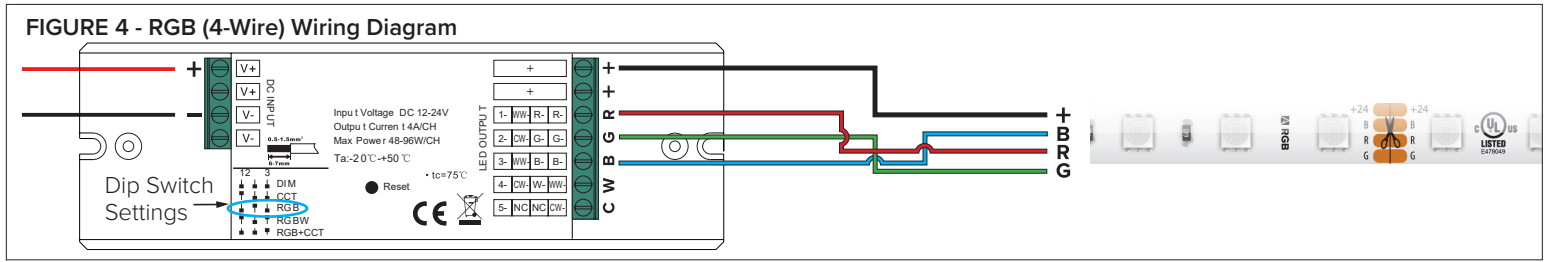

FIGURE 3 - Tunable CCT (3-Wire) Wiring Diagram



INSTALLATION INSTRUCTIONS

SPKPL-REC-TB-5CH



CONTROLLING THE SPEKTRUM+ SMART RECEIVER: The in-line Spektrum+ Smart Receiver utilizes Bluetooth Wireless Technology and can be controlled via the Spektrum+ Smart Lighting App on any iOS (9.0 and later) or Android (4.4 or later) smart device. Please follow the Spektrum+ Smart Lighting App guide included for pairing and functionality.

The Spektrum+ Smart Receiver (SPKPL-REC-TB-5CH) can not be controlled by any other App or smart device not using the Spektrum+ Smart Lighting App. It is not intended to be used on a standard dimming circuit.

DISTANCE OF CONTROL CAPABILITY: 25 meters (approx. 80ft) clear line of sight & signal. It is not recommended to place the Smart Receiver into a metal or thick enclosure as it may interfere with overall signal and reception resulting in inoperable devices.

TO RESET THE SMART RECEIVER DEVICE TO FACTORY SETTINGS (See Figure 7):

Press and hold the reset button on the receiver for 5 seconds.

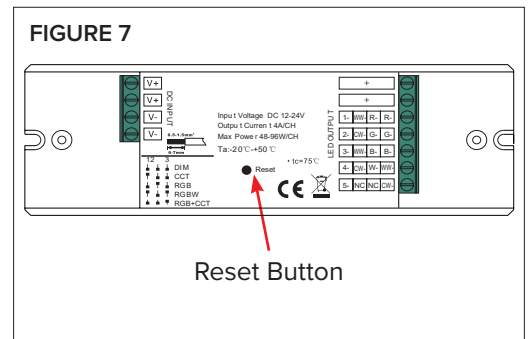

FCC Compliance Statement

This device complies with part 15 of the FCC Rules. Operation is subject to the following two conditions:

1. This device may not cause harmful interference, and
2. This device must accept any interference received, including interference that may cause undesired operation.

FCC WARNING

This equipment has been tested and found to comply with the limits for a Class B digital device, pursuant to Part 15 of the FCC Rules. These limits are designed to provide reasonable protection against harmful interference in a residential installation. This equipment generates, uses and can radiate radio frequency energy and, if not installed and used in accordance with the instructions, may cause harmful interference to radio communications. However, there is no guarantee that interference will not occur in a particular installation. If this equipment does cause harmful interference to radio or television reception, which can be determined by turning the equipment off and on, the user is encouraged to try to correct the interference by one or more of the following measures:

- Reorient or relocate the receiving antenna.
- Increase the separation between the equipment and the receiver.
- Connect the equipment into an outlet different from that to which the receiver is connected.
- Consult the dealer or an experienced radio/TV technician for help.

Changes or modifications not expressly approved by the party responsible for compliance could void the user's authority to operate the equipment.