



PROJECT: TYPE:

LOCATION: CAT:



Black



Green

Description

Use Commercial Grade Light String for decorative, event oriented, or festive lighting applications.

Features

- 16AWG SPT-2 wire light string available in 330ft bulk reels
- Formulated PVC sockets form a tight seal around bulbs to preclude the entrance of water and moisture
- Non-suspended socket has two mounting ears built into the base
- Use with E12 base Long Life Incandescent Lamps or Pro Decorative Lamps (sold separately)

Mounting

For spans up to 20 feet, use eye bolts and plastic ties to anchor ends. For spans longer than 20 feet, use catenary cable (sold separately) with plastic ties at each socket.

Applications

Patios, overhangs, art installations, tents for weddings or festivals



Technical Information

Series	LS-C-12-BK	LS-C-12-GR
Length	330ft	330ft
Socket Type	Solid E12 Base	
Socket Spacing	12"	
Total Sockets	330	330
Wire Color	Black	Green
Wire Type	16AWG SPT-2 wire; No plug, No terminated end	
Voltage	120V AC, 60Hz	
Max Watts Per Socket	10 watts max per socket	
Max Run	1200 watts	
Cuttability	All cut ends must be sealed properly to preclude the entrance of water**	
Rating	Indoor/Outdoor; Suitable for year-round use*; IP64**	
Rated Life	Varies by lamp used	

*All LS-C products are non-rated. Not intended for installation in ceilings, soffits, cabinets or other enclosed spaces.

**For non-rated LS product, any cut ends must be sealed properly to preclude the entrance of water.

Keep lamp at least 4.9m/16ft from pools and spas.

LS-C Socket Dimensions

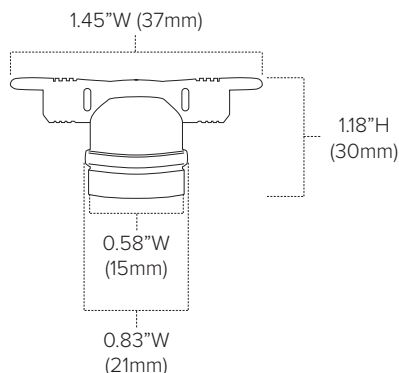

LS-C '330ft Reel' Lead Wire: 12\"/>

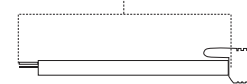

LS-C '330ft Reel' Tail Wire: 4\"/>

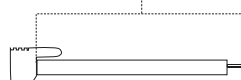

Ordering Information

120V LS-C Series 330ft Bulk Reels

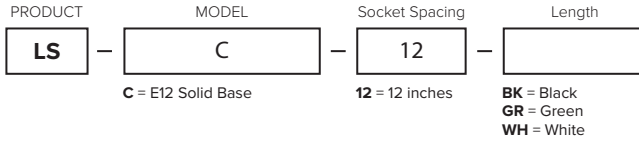







120V LS-C Series 330ft Bulk Reels Include:
(1) 330ft length of LS series commercial grade light string without plug and without terminated end

Example Part # **LS-C-12-BK**



Accessories

Image	Item	Description
	M-PLUG-BK-SPT2-B	Black SPT-2 Male Plugs Slide-on, two prong plugs for SPT-2 2-Wire (Qty of 25)
	M-PLUG-WH-SPT2-B	White SPT-2 Male Plugs Slide-on, two prong plugs for SPT-2 2-Wire (Qty of 25)
	Compatible Lamps	Pro Decorative Series: PG30-E12, PCA10-E12, and PC7-E12 Premium LED Series: NC7-LED2 Long Life Incandescent: B7.5C, C7-5, and C7-7
	LS-CABLE-60	60ft Catenary Cable Kit Includes: (1) 60ft length of 1/8" diameter catenary/guide cable for light string installation, (2) Heavy duty cable locks, and (1) Cable release key
	LS-CABLE-110	110ft Catenary Cable Kit Includes: (1) 110ft length of 1/8" diameter catenary/guide cable for light string installation, (2) Heavy duty cable locks, and (1) Cable release key
	LS-CABLE-500	500ft Catenary Cable Bulk Reel Includes: (1) 550ft length of 1/8" diameter catenary/guide cable for light string installation
	LS-LOCK-4	(4) Heavy duty cable locks for 1/8" catenary cable; Support loads up to 330lbs; Includes cable release key
	LS-TT	Tensioning Tool; use to eliminate sag from catenary cable. Never tighten cable before load is attached; Never over-tighten cable

Additional Information

SUSPENDING LIGHT STRINGS:

Light sockets must be suspended so that bulbs are facing down only. **DO NOT MOUNT THE LIGHT STRINGS WITH SOCKETS FACING UPWARD!**

1. Light string must be securely attached to a support structure at each end of each span. The maximum unsupported span distance for 48' Cord & Plug Light String is 20 feet (10 sockets).
2. Secure light string to supporting hardware (eyebolts, brackets, etc., not provided) using cable ties (not included). See Figure 1.
3. Ensure any cut ends are properly sealed to preclude the entrance of water.
4. For spans exceeding 20 feet, use properly rated cable support system and cable ties (neither are provided with the light string) and follow local codes for suspended cables and loads. See www.americanlighting.com for steel cable support systems, if needed.

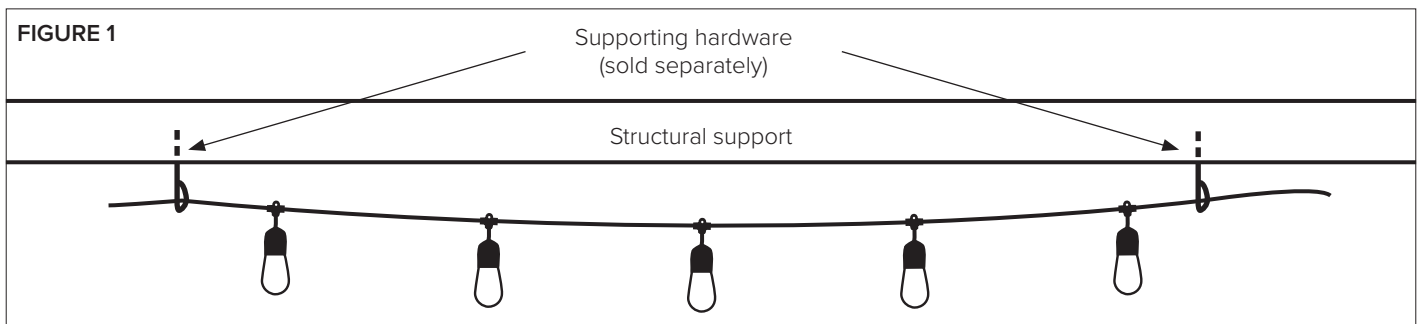



AMERICAN LIGHTING WARRANTY

LIMITED WARRANTY FOR LED PRODUCTS: 1 YEAR

LIMITED PRODUCT WARRANTY

Our products are warranted to be free from defects in material and workmanship for the warranty period listed. Warranty periods begin from the date of shipment from American Lighting Inc's warehouse to the original purchaser. Products that prove to be defective during their specific warranty period will be either repaired or replaced, at the sole discretion of American Lighting Inc. Claims for defective products must be submitted in writing to American Lighting Inc's RGA Department within the warranty period. Upon approval of such return, American Lighting Inc reserves the right to inspect the product for misuse or abuse. Claims for indirect or consequential damages or for product that, in American Lighting Inc's opinion, has been misused will be denied. This is a warranty of product reliability only and not a warranty of merchantability or fitness for a particular purpose. American Lighting Inc shall have no liability whatsoever in any event for payment of incidental or consequential damages, including, without limitations, installation costs and/or damages for personal injury and/or property. These products may represent a possible shock or fire hazard if improperly installed or altered in any way. This warranty does not apply to any product that has not been properly installed in accordance with current local codes and/or the National Electrical Code. Products that require a transformer, driver, or power supply must be used in conjunction with American Lighting Inc's recommended power supply to ensure safety and retain product warranty.

PRODUCT SPECIFICATIONS

For the latest product information, updates, instructions and details concerning specifications, colors, finishes, performance, installation and design, visit www.americanlighting.com. Color may vary from the color printed herein due to limitations in photographic and printing processes. American Lighting Inc. reserves the right to change product specifications without notice. Other product specifications such as color temperature, wavelength characteristics and lumen output are subject to production limitations and may vary. LED technology is changing rapidly, and not all color temperatures and performance levels can be duplicated at a later time. Best practices include purchasing 10-15% more for a particular project on the same initial order where white LED color temperatures must be maintained over project and product life. Eventual product replacement should be considered at layout and design stages. Best practices also include testing connections and product performance prior to mounting and/or installing.

AVERAGE LIFE

Average incandescent lamp life, rated life and average life are terms used to describe the number of hours at which half of the lamps have failed. For LEDs, the hours of rated life specify the point where 70% of original lumen output is reached. Below this point, the effective life is over, however, the LED may still emit light. Individual results may vary with actual environmental conditions including, but not limited to, proper installation, ambient temperature and/or input voltage fluctuations.